

GENERAL

**ASGHARIAN
HOLDING**

Refrigerant
R410A
INVERTER

**TROPICAL
SPEC**



VRF System

AIRSTAGE™ V-III

TROPICAL series

**50
HZ**

FUJITSU GENERAL LIMITED

Creation of Comfort



Fujitsu General have been developing and manufacturing high quality and energy efficient products for more than 35 years. Using the latest Japanese technology and state of the art expertise, our products have been designed in accordance with our policy to "create the most comfortable environment" possible.



HISTORY



Providing the maximum satisfaction to all customers

FUJITSU GENERAL's VRF "AIRSTAGE" Series has been developed based on our long-term air-conditioning technology know-how and was first provided 11 years ago. We have offered a series of products from large homes to large-scale buildings to meet the various market needs.

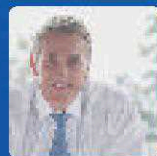

Building owners



Installers



End users



Service and Management companies



NEW

AIRSTAGE™ V-III

TROPICAL series

V-III Tropical spec model
Extensive lineup from 8HP to
54HP in 2HP increment / Heat pump



AIRSTAGE VR-II

VR-II series
High efficiency and
Compact design model
8 to 48HP / Heat Recovery



AIRSTAGE V-II

V-II TROPICAL series
Tropical spec model
Extensive lineup from 8HP to
42HP in 2HP increment /
Heat pump



AIRSTAGE J-IIS

J-IIS series
High efficiency and
compact design model
4HP to 6HP / Heat pump



AIRSTAGE V-III

V-III series
High efficiency and
large capacity model
Extensive lineup from 8HP to
54HP in 2HP increment /
Heat pump

2012

2013

2014

2015

2016

High quality development and production environment

The Headquarters-R&D Center (Japan) is equipped with a wide range of testing equipment envisioning a variety of operating conditions. This includes a testing tower with a 60m height difference for buildings. We provide high quality & reliable products that meet the customers' needs from all over the world through this advanced R&D Center and 6 factories based in China and Thailand.



R&D Center (Japan) and 60m height testing tower
Central R&D center for global air conditioner development.



FUJITSU GENERAL CENTRAL AIR-CONDITIONER(WUXI)CO.,LTD. (China)
VRF Main factory. ISO9001 and ISO14001 certified.

Fujitsu General's VRF System Designed by Tropical Spec



Fujitsu General tropical VRF is designed for tropical weather. High performance is achieved even at high outdoor temperatures by using of high outdoor temperature compatible electronic parts, large heat exchanger, high performance rotary compressor, and high performance inverter control.

Feature High Performance

Max. 18HP in single unit offers selection from wide capacity combination range.



Feature High Efficiency Operation

Economy saving technology saves energy consumption at high ambient temperature.

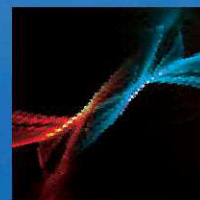

Feature High Reliability

Heavy anti-corrosion treatment works salt pollution, dust and high ambient temperature.



C O N T E N T S

FEATURES

High Performance	6
High Efficiency Operation	8
High Reliability	10
Comfort and Convenience	12
Easy Installation	14
Easy Service & Maintenance	16

OUTDOOR UNITS

Outdoor Units Lineup	18
Outdoor Units Specifications	20

INDOOR UNITS

Indoor Units Lineup	22
Compact Cassette	24
Cassette	26
Mini Duct	30
Slim Duct / Slim Concealed Floor	32
Low Static Pressure Duct	34
Medium Static Pressure Duct	36
High Static Pressure Duct	38
Large Airflow Duct	42
Floor / Ceiling	44
Ceiling	46
Wall Mounted	48

CONTROLLER

Control System Overview	52
Wiring System	54
Comparison table of Controllers	55

INDIVIDUAL CONTROLLER

Wired Remote Controller (Touch Panel)	56
Wired Remote Controller	58
Simple Remote Controller	59
Wireless Remote Controller	60
IR Receiver Unit	61

CENTRALIZED CONTROLLER

Group Remote Controller	62
Central Remote Controller	63
Touch Panel Controller	64
System Controller (Software)	66
System Controller Lite (Software)	66

CONVERTOR / ADAPTOR

BACnet® Gateway	70
Network Convertor for LonWorks®	71
External Switch Controller	72
Signal Amplifier	72
Network Convertor	73
Network Convertor	74
MODBUS® Convertor	75

SERVICE & MAINTENANCE TOOL

Service Tool (Software)	76
Web Monitoring Tool (Software)	78

VENTILATION

Energy Recovery Ventilator	80
Outdoor Air Unit	82

OPTION

Auto Louver Grille Kit (Option)	84
Optional Parts	85

REFERENCE

Applications	90
--------------------	----



AIRSTAGE™ V-III
Variable Refrigerant Flow System

TROPICAL series

High Performance

Single unit in V-III TROPICAL series has been achieved top-class Max.18HP.
 Extended outdoor and indoor units combination, installation of outdoor units and design flexibility have been much improved.



Wide capacity combination range

System capacity range has been extended from 8HP To 54HP with 2HP increments. 39 models with space saving and high energy efficiency types.

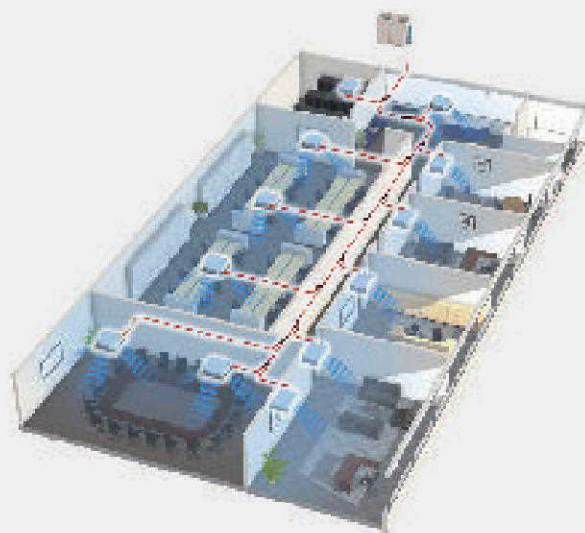
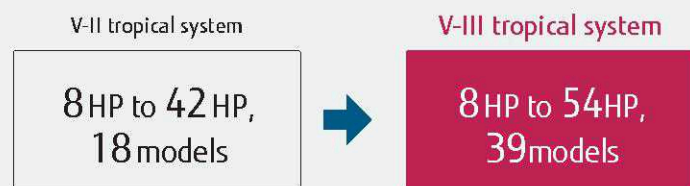

Flexible indoor unit combination

12 types, 84 models* of indoor units can be selected ranging from 2.2kW to 28kW in capacity. A maximum of 150% indoor unit connectable capacity.

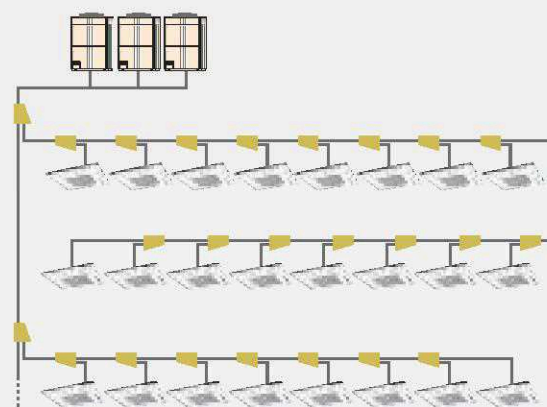
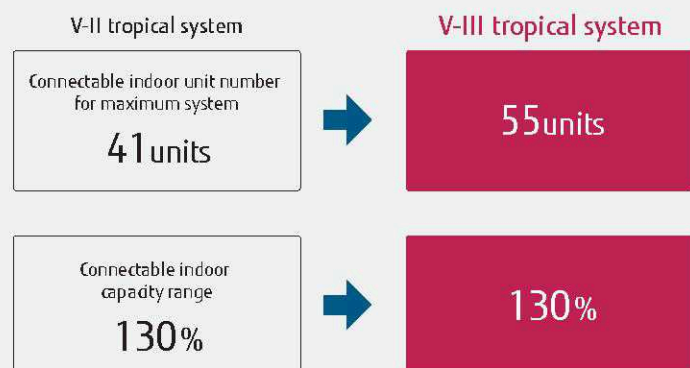

Note: When indoor unit connected capacity is greater than 100%, individual indoor units will operate at a slightly lower capacity when maximum capacity is required.

Space saving and compact size

Compact size has been achieved by significantly reducing the width of the outdoor units compared to previous models.



Overall piping length 1,000m

World's top class overall piping length of 1,000m allows for application in a wide variety buildings.

Total pipe length
1,000^{*1} m max.

*1. Note : When there is 1 outdoor unit, the maximum is 700m.

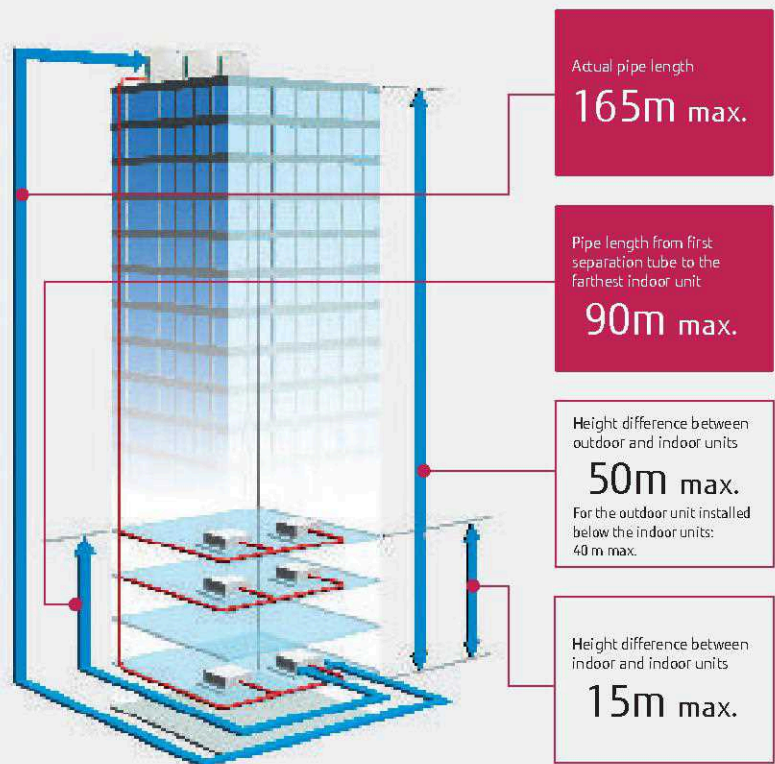

High static pressure of 82Pa

The outdoor unit can have a condenser hood easily connected with a static pressure of 82Pa standard. This allows outdoor units to be installed within plant rooms in high rise buildings.

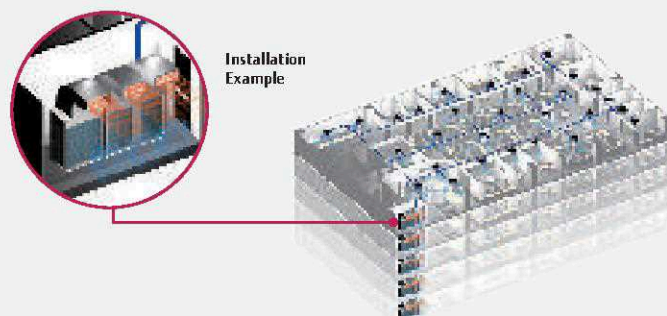

Powerful discharge with an external static pressure of 82Pa.

82Pa
as standard



Large diameter fan and DC motor has been utilized allowing an external static pressure of 80Pa. This is approximately 2.6 times greater than the previous model.

High Efficiency Operation

Advanced system considers high efficiency operation



Energy saving technology that boosted operation efficiency



Powerful large propeller fan

By using CFD*1 technology, a newly designed fan achieves high performance and low noise operation.
*1. CFD = Computational Fluid Dynamics



3 phase DC fan motor

Efficiency is substantially improved by high efficient motor with sophisticated driver control. In addition, low noise is realized by DC fan motor.



Subcool heat exchanger

High Heat Exchange efficiency is achieved by using an internal projection shape double pipe construction.



Sine-wave DC inverter control

High efficiency is realized by adoption of reduced switching loss IPM.



High efficient and large capacity DC inverter compressor

Large capacity high efficient DC twin rotary compressor with excellent intermediate capability.



4-face heat exchanger

Heat exchange efficiency is significantly improved by the introduction of a new 4-face heat exchanger that increases effective surface area.

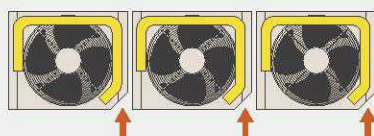

Front intake port (corner cut air inhaling structure)

In multiple outdoor unit installations, the unique front intake design improves airflow into the Heat Exchanger.

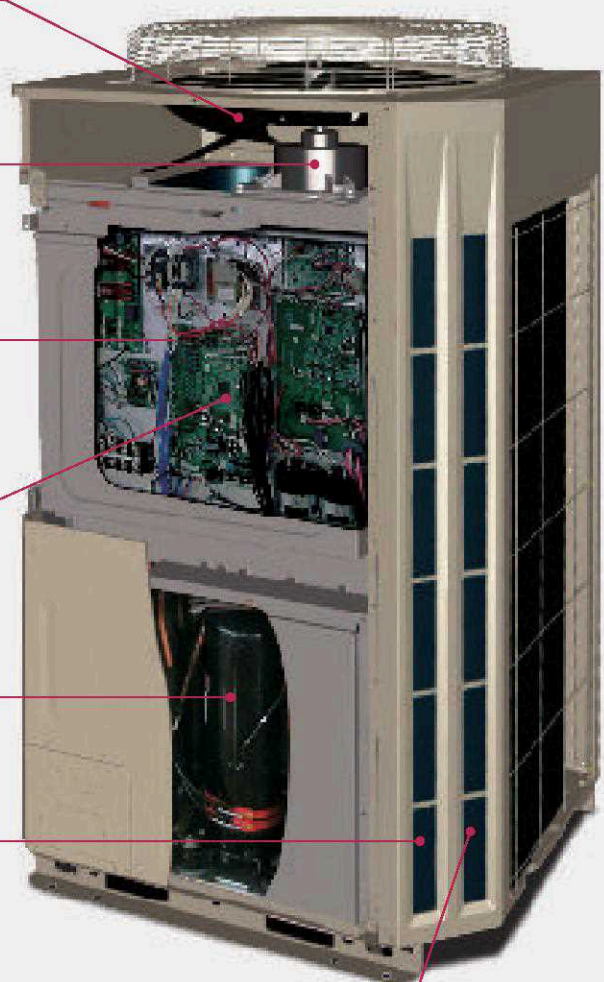

Efficiency in actual operation

High efficiency operation is realized for all combinations by our unique exchanger structure, high efficient DC inverter compressor, and other our own technologies.



ALL INVERTER

Large capacity DC inverter compressor
Large capacity high efficient DC twin rotary compressor with excellent intermediate capability.



3 phase DC fan motor



High efficient compressor speed control
Comfortable space with small room temperature changes and little energy loss is created by 0.1 Hz steps compressor speed control.

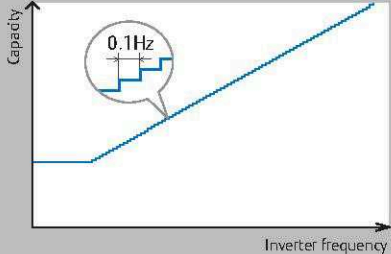

Sine-wave DC inverter control



Advanced energy saving control

Multiple outdoor operation control

When multiple outdoor units are connected a sophisticated operation is performed by each compressor. This control method operates all compressors at part load and distributes refrigerant to all of the heat exchangers.

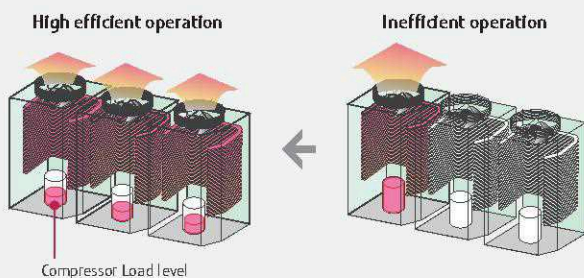

Heat exchanger refrigerant control

The heat exchanger in the outdoor unit is split into two parts (Top and Bottom). The efficiency of the heat exchanger has been improved by adopting an optimum refrigerant path control where the refrigerant is distributed more into the top heat exchanger.

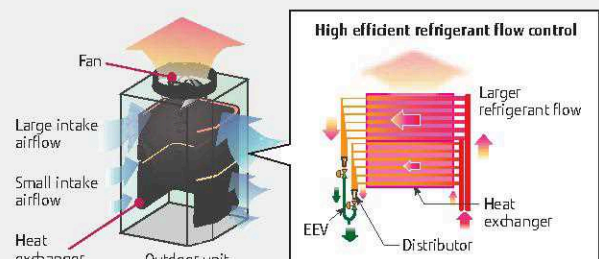

High Reliability

High reliability considering long-term safety and confidence



Heavy anti-corrosion treatment design



Anti-corrosion coated casing parts

Satisfied the JRA* heavy anti-corrosion regulation(4002)

PCB and Electronic components



High ambient temperature compatible electric components. Added silicon coating on all PCB circuits for anti-corrosion.



High ambient & corrosion compatible

PCB componets
Refrigerant cycle component

Blue fin heat exchanger



Hydrophilic coating
Cobalt Blue protection
Aluminium base material
Cobalt Blue protection
Hydrophilic coating

All screws and hinges



Added zinc chrome acid film treatment.

*JRA:
Japan Refrigeration
Association

High ambient operation design



Possible to operate cooling up to 52°C outdoor temperature by adopting DC fan motor, large propeller fan and large heat exchanger.

Cooling operation up to 52°C ambient

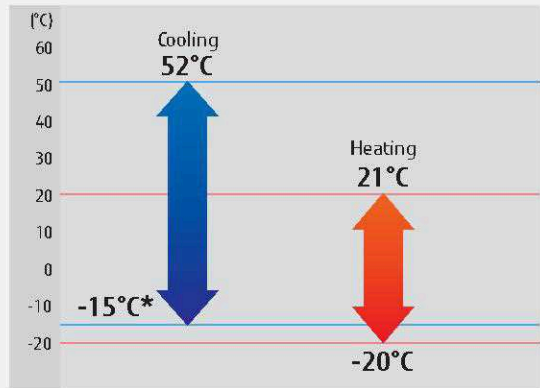

*:When a multiple outdoor unit connection is used, operating range is from -5°C to 52°C in cooling.

Life-extending operation

Outdoor unit rotational operation

The compressor starting order is rotated so that the running time is shared.

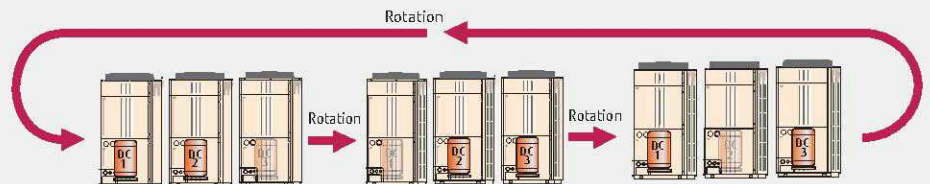

Note: Rotational operation is alternated by the start / stop timing of the compressor.

Backup operation

If one of compressor fails, backup operation will be performed by the remaining compressors as emergency.*1

*1 Note: Backup operation may not be possible depending on the combination and trouble state.

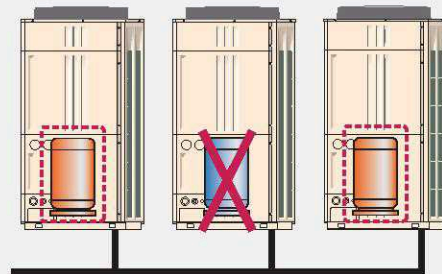

Liquid back flow protection

By adopting a large sized accumulator, the refrigerant which is not completely vapourised stays inside of the accumulator to ensure no liquid refrigerant is fed back into the compressor.

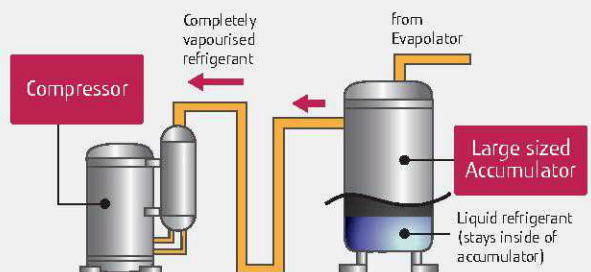

Oil Recovery operation

Periodic oil recovery operation is done automatically in order to feed back oil from the indoor unit to compressor.

Comfort and Convenience

Low noise, easy operational settings, and comfortable temperature adjustment allows for V-III TROPICAL series to be used in building air conditioning applications.

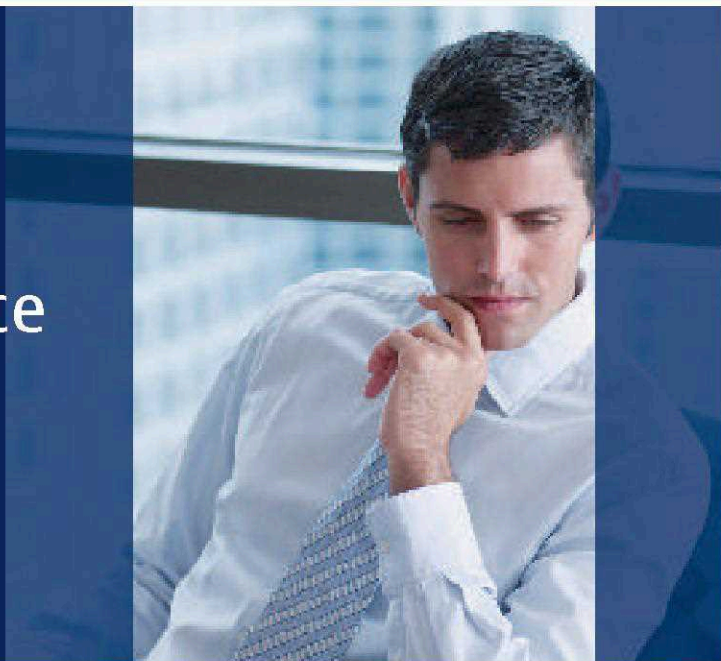

Powerful cooling capacity design



High cooling power has been realized by adopting large heat exchanger, high capacity DC inverter compressor, sub-cooler equipment, etc.

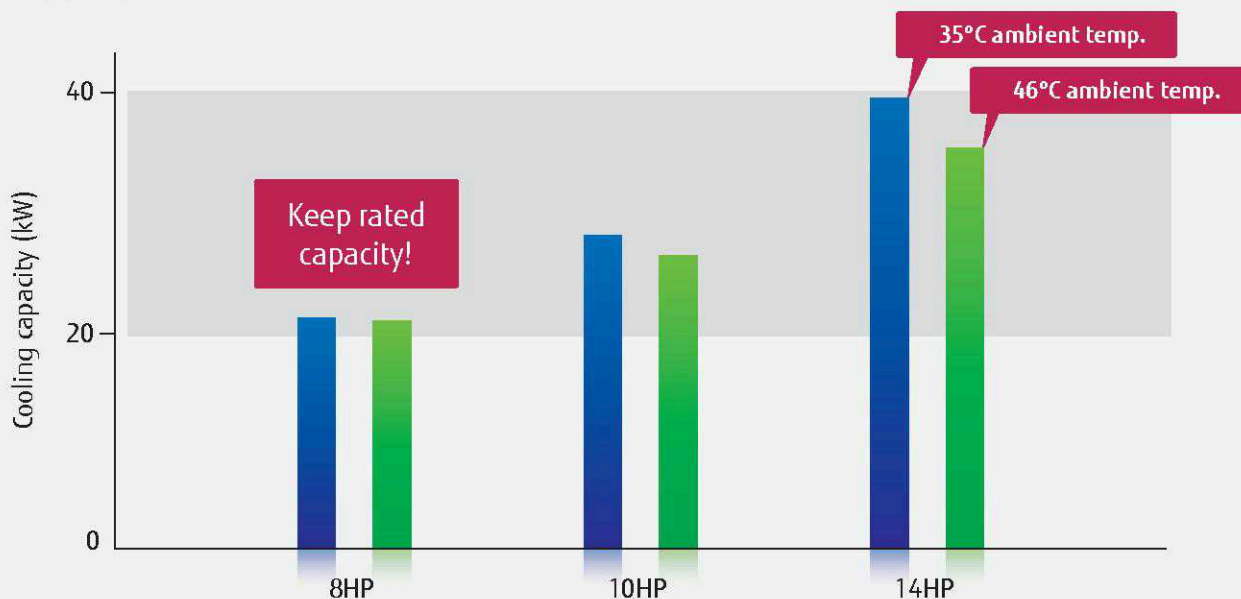

Touch Panel Wired Remote Controller

The new wired remote controller has an easy to use LCD touch panel. This new controller has a back light function and can easily control the air conditioner which provides a better energy saving operation of the air conditioner.



Precision refrigerant flow control

Precision and Smooth refrigerant flow control is achieved by using a DC Inverter control in conjunction with individual indoor unit electronic expansion valve control. This allows for a high precision comfortable temperature control of $\pm 0.5^{\circ}\text{C}$.

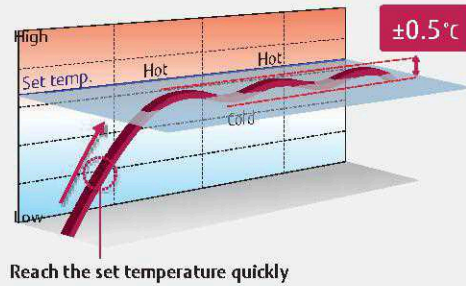

Thermal change of the room
*Simulation in heating operation.

Comfortable operation is achieved due to a small variation of room temperature

Quiet operation

Low noise mode

Two low noise modes can be selected automatically by quiet priority setting and capacity priority setting depending on the usage environment and outside temperature load.

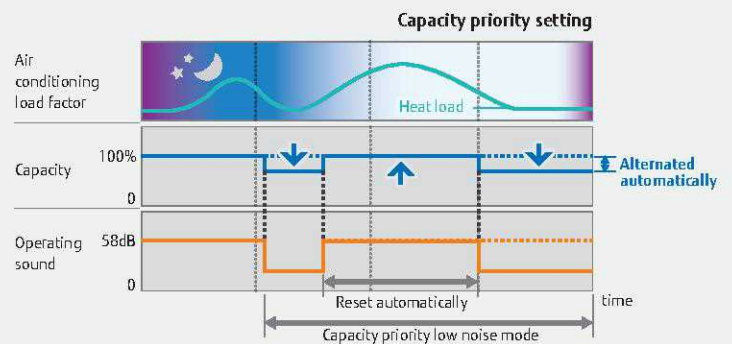
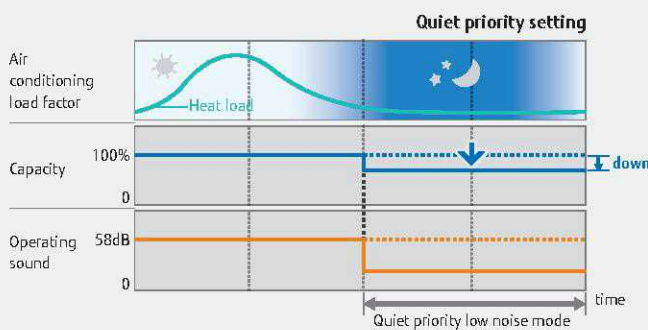

Non-stop oil recovery operation

A comfortable room condition is maintained during oil recovery mode because the product continues to operate without stopping the cooling or heating operation.



Auto changeover function

Auto changeover setting allows for the product to easily switch between cooling and heating modes regardless of the operation mode of other indoor units. This can be done via specific indoor unit with wired remote controller. This ensures comfortable operation all year round.



Switching to cooling and heating mode by specific remote controller in the main room, etc



Easy Installation

From transportation of the product to address setting for commissioning, significant improvements have been made which reduce the cost of installation.

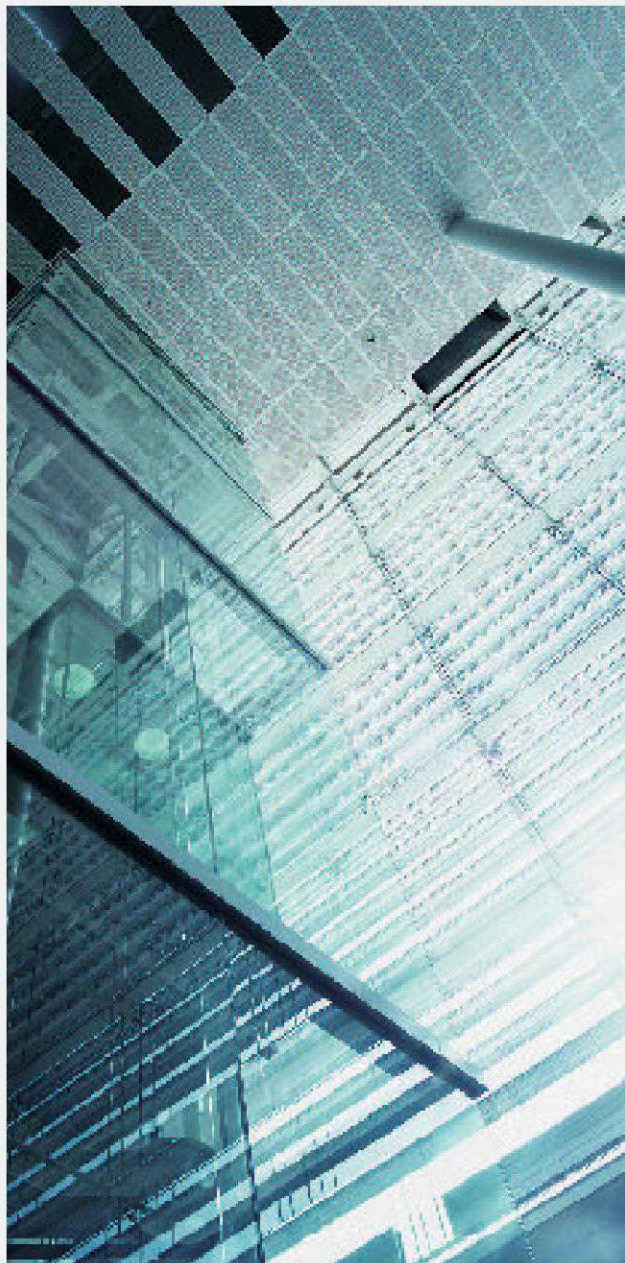
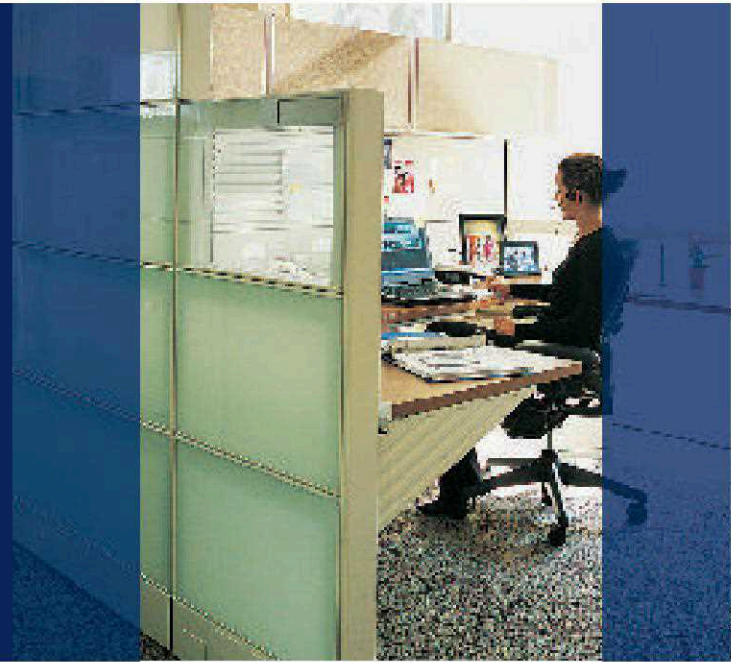

Easily transported

Light weight



8%
weight reduction
(Than Previous model)

Note: In the case of 14HP

Easily craned using lifting belt hooks

Design of outdoor unit allows for lifting straps to be used



Can be transported in a small elevator



Transporting by forklift

Transport with forklift is possible.

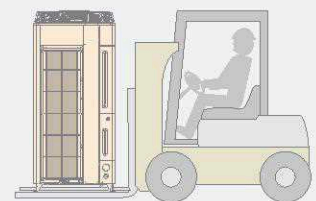

Easy piping connection

Piping connection can be done using separation tube & header.

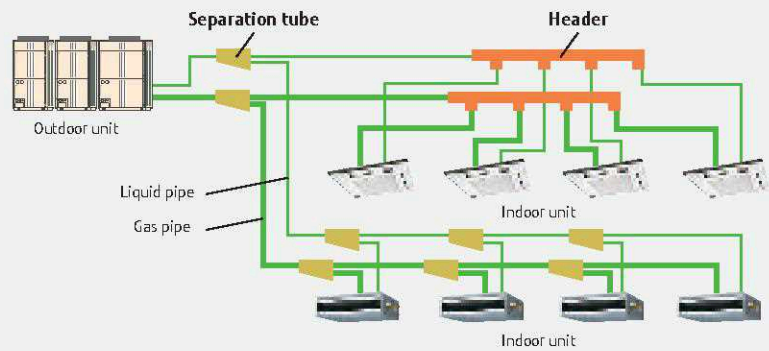

Simple transmission network connection

Installation is made easier as the communication wiring can be connected continuously to any component.

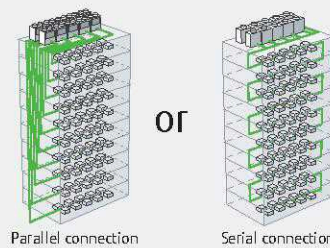

Up to maximum length 3,600m

Note: Serial connection can't use the automatic address setting in a multiple refrigerant system.

Easy access

By adopting a L-Shape front panel that can be removed, the work space for installation and service has been significantly expanded by this new design. For multiple installations, work is performed easily and efficiently even in a narrow space.

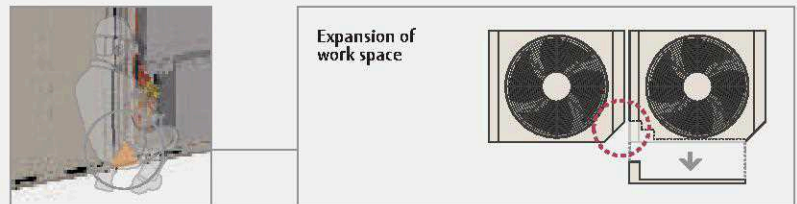

Flexible piping connection

Piping and wiring are available to the front, left and right, and bottom.

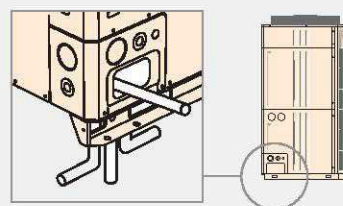

Automatic address setting

The address of each indoor unit can be automatically set by button switch of outdoor unit.

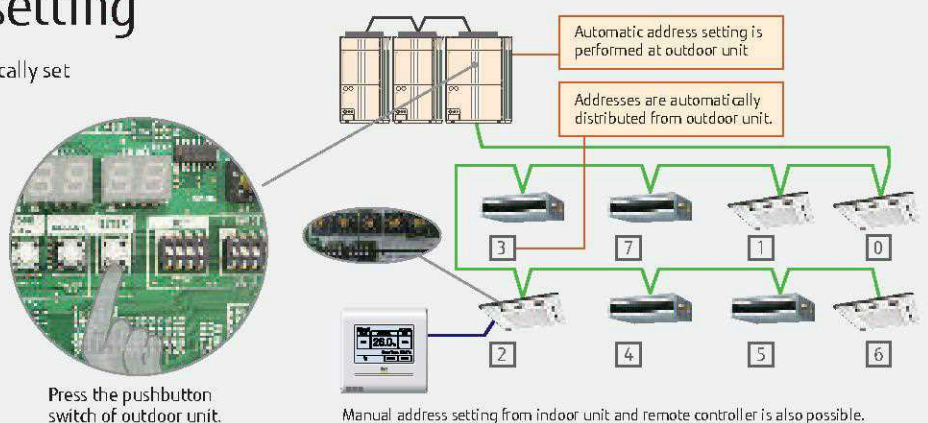



Easy Service & Maintenance

Designed for Quick Service response,
Easy maintenance and Troubleshooting

Design for easy service and maintenance

Inspection and replacement of main parts are easier due to innovative construction and an LED operational display.

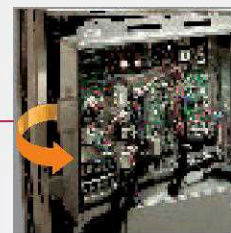
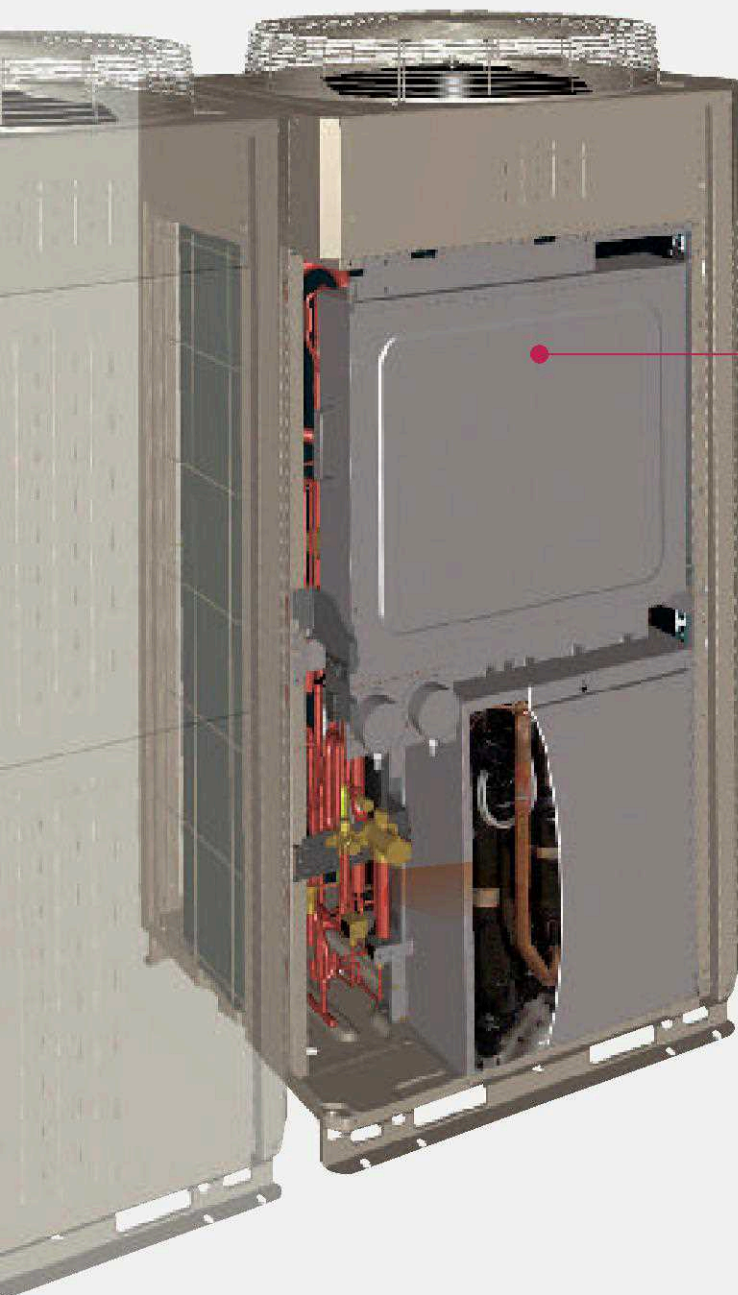

Consolidated electrical components make maintenance easy
Movable PCB panel that allows for easier maintenance work behind the PCB

Easy-to-read 7-segment LED display which explains operational and trouble status

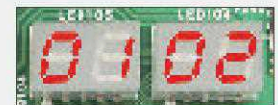

Maintenance of electrical components, valves, and compressor parts from the front is possible.

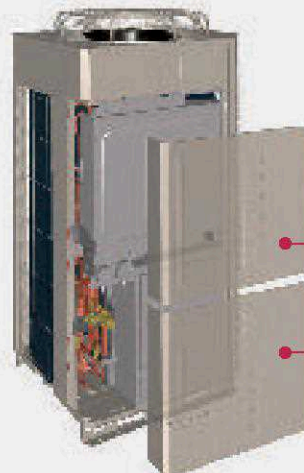

Split front panel
Split front panel allows for maintenance from top or bottom of the outdoor unit

Error status can be checked easily via the indoor unit wired controller

An error code is displayed on a liquid crystal screen.

Wired Remote Controller



Faulty unit number (Remote controller address)
Error code



Simple Remote Controller



Remote controller address
Error code

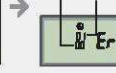

Continuous operation during maintenance

Non-stop operation

When servicing a specific indoor unit, maintenance can be performed even without turning off the other indoor units.

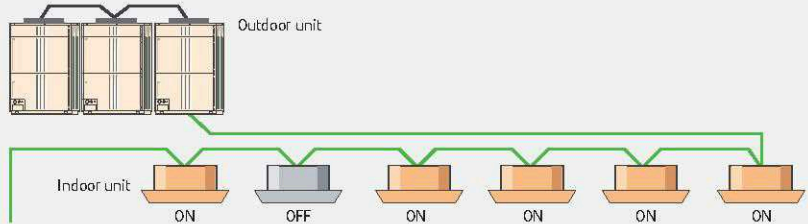

Trouble diagnosis by Service Tool

Suitable maintenance is possible by analysis of the operation data. Connection anywhere in the VRF network is easy.

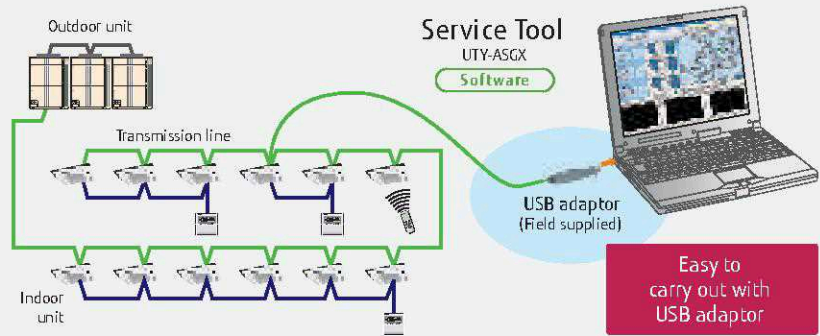

Easy to carry out with USB adaptor

Remote monitoring

The Web Monitoring system allows you view system operation at all times over the internet ensuring trouble free operation.

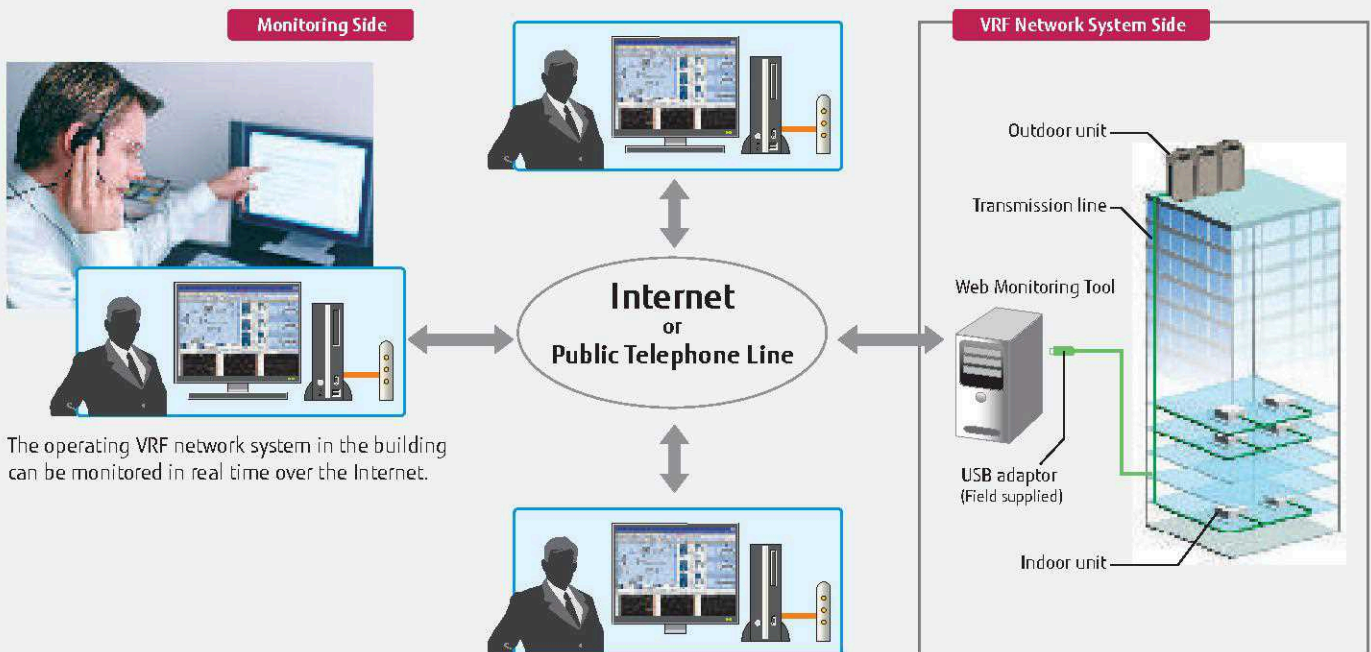















The operating VRF network system in the building can be monitored in real time over the Internet.

OUTDOOR UNITS LINEUP

• Combinations other than the followings are not recommended.

Space saving combination

<p>22.4kW (8HP)</p>  <p>AJH072LN*BH UNIT : AJH072LN*BH</p>	<p>28.0kW (10HP)</p>  <p>AJH090LN*BH UNIT : AJH090LN*BH</p>	<p>33.5kW (12HP)</p>  <p>AJH108LN*BH UNIT : AJH108LN*BH</p>	<p>40.0kW (14HP)</p>  <p>AJH126LN*BH UNIT : AJH126LN*BH</p>	<p>45.0kW (16HP)</p>  <p>AJH144LN*BH UNIT : AJH144LN*BH</p>	<p>50.0kW (18HP)*</p>  <p>AJH162LN*BH UNIT : AJH162LN*BH</p>
<p>56.0kW (20HP)</p>  <p>AJH180LN*BH UNIT : AJH090/090LN*BH</p>	<p>62.4kW (22HP)</p>  <p>AJH198LN*BH UNIT : AJH126/072LN*BH</p>	<p>68.0kW (24HP)</p>  <p>AJH216LN*BH UNIT : AJH126/090LN*BH</p>	<p>73.0kW (26HP)</p>  <p>AJH234LN*BH UNIT : AJH144/090LN*BH</p>	<p>78.0kW (28HP)*</p>  <p>AJH252LN*BH UNIT : AJH162/090LN*BH</p>	<p>80.0kW (28HP)</p>  <p>AJH252LN*BHA UNIT : AJH126/126LN*BH</p>
<p>85.0kW (30HP)</p>  <p>AJH270LN*BH UNIT : AJH144/126LN*BH</p>	<p>90.0kW (32HP)</p>  <p>AJH288LN*BH UNIT : AJH144/144LN*BH</p>	<p>95.0kW (34HP)*</p>  <p>AJH306LN*BH UNIT : AJH162/144LN*BH</p>	<p>96.0kW (34HP)</p>  <p>AJH306LN*BHA UNIT : AJH126/090/090LN*BH</p>	<p>100.0kW (36HP)*</p>  <p>AJH324LN*BH UNIT : AJH162/162LN*BH</p>	<p>101.0kW (36HP)</p>  <p>AJH324LN*BHA UNIT : AJH144/090/090LN*BH</p>
<p>106.0kW (38HP)*</p>  <p>AJH342LN*BH UNIT : AJH162/090/090LN*BH</p>	<p>108.0kW (38HP)</p>  <p>AJH342LN*BHA UNIT : AJH126/126/090LN*BH</p>	<p>113.0kW (40HP)</p>  <p>AJH360LN*BH UNIT : AJH144/126/090LN*BH</p>	<p>118.0kW (42HP)</p>  <p>AJH378LN*BH UNIT : AJH144/144/090LN*BH</p>	<p>123.0kW (44HP)*</p>  <p>AJH396LN*BH UNIT : AJH162/144/090LN*BH</p>	<p>128.0kW (46HP)*</p>  <p>AJH414LN*BH UNIT : AJH162/162/090LN*BH</p>
<p>135.0kW (48HP)</p>  <p>AJH432LN*BH UNIT : AJH144/144/144LN*BH</p>	<p>140.0kW (50HP)*</p>  <p>AJH450LN*BH UNIT : AJH162/144/144LN*BH</p>	<p>145.0kW (52HP)*</p>  <p>AJH468LN*BH UNIT : AJH162/162/144LN*BH</p>	<p>150.0kW (54HP)*</p>  <p>AJH486LN*BH UNIT : AJH162/162/162LN*BH</p>		

AJH__LN* : AJH__LNL, AJH__LNT * : Not available to sale in some regions

Energy efficiency combination

<p>44.8kW (16HP)</p>  <p>AJH144LN*BHH UNIT : AJH072/072LN*BH</p>	<p>50.4kW (18HP)</p>  <p>AJH162LN*BHH UNIT : AJH090/072LN*BH</p>	<p>55.9kW (20HP)</p>  <p>AJH180LN*BHH UNIT : AJH108/072LN*BH</p>	<p>67.2kW (24HP)</p>  <p>AJH216LN*BHH UNIT : AJH072/072/072LN*BH</p>	<p>72.8kW (26HP)</p>  <p>AJH234LN*BHH UNIT : AJH090/072/072LN*BH</p>	<p>78.3kW (28HP)</p>  <p>AJH252LN*BHH UNIT : AJH108/072/072LN*BH</p>
<p>84.8kW (30HP)</p>  <p>AJH270LN*BHH UNIT : AJH126/072/072LN*BH</p>	<p>89.4kW (32HP)</p>  <p>AJH288LN*BHH UNIT : AJH108/108/072LN*BH</p>	<p>95.9kW (34HP)</p>  <p>AJH306LN*BHH UNIT : AJH126/108/072LN*BH</p>	<p>100.5kW (36HP)</p>  <p>AJH324LN*BHH UNIT : AJH108/108/108LN*BH</p>	<p>107.0kW (38HP)</p>  <p>AJH342LN*BHH UNIT : AJH126/108/108LN*BH</p>	<p>113.5kW (40HP)</p>  <p>AJH360LN*BHH UNIT : AJH126/126/108LN*BH</p>
<p>120.0kW (42HP)</p>  <p>AJH378LN*BHH UNIT : AJH126/126/126LN*BH</p>	<p>125.0kW (44HP)</p>  <p>AJH396LN*BHH UNIT : AJH144/126/126LN*BH</p>	<p>130.0kW (46HP)</p>  <p>AJH414LN*BHH UNIT : AJH144/144/126LN*BH</p>			

AJH__LN* : AJH__LNL, AJH__LNT

Dimensions

8,10HP : AJH072LN*BH / AJH090LN*BH

(Unit : mm)

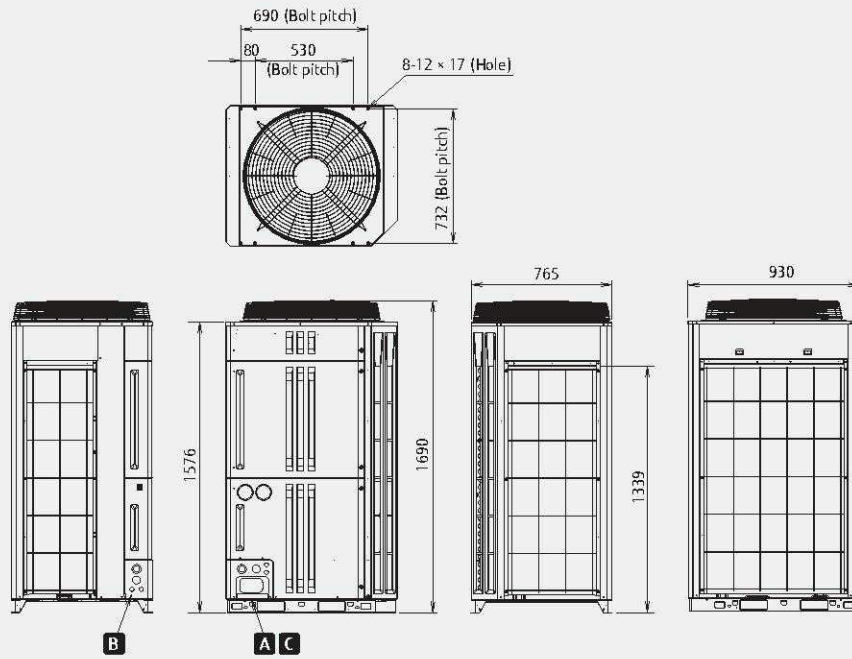

AJH_LN*: AJH_LNL, AJH_LNT

12,14,16,18HP : AJH108LN*BH / AJH126LN*BH / AJH144LN*BH / AJH162LN*BH

(Unit : mm)

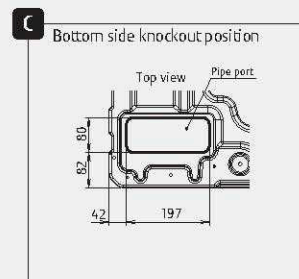
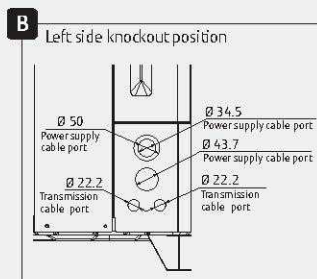
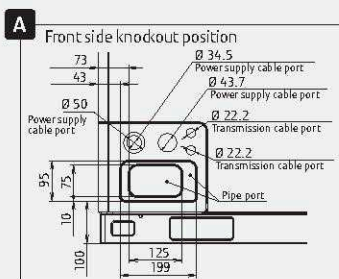
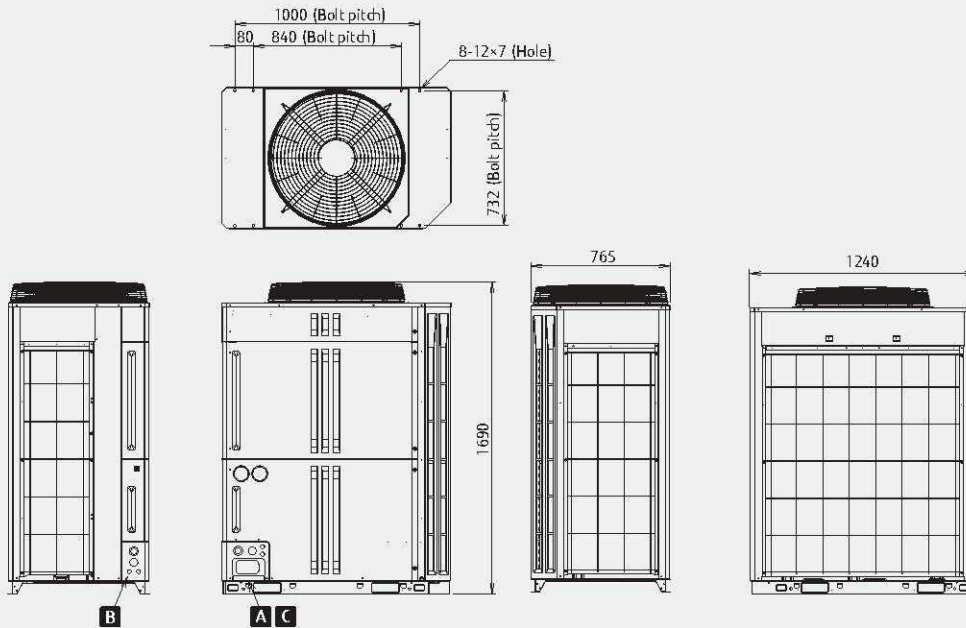

AJH_LN*: AJH_LNL, AJH_LNT

OUTDOOR UNITS SPECIFICATIONS

Space saving combination

Rating Capacity range		HP	8	10	12	14	16	18	20	22	24	26	28*	28		
Model name			AJH072LN*BH	AJH090LN*BH	AJH108LN*BH	AJH126LN*BH	AJH144LN*BH	AJH162LN*BH	AJH180LN*BH	AJH198LN*BH	AJH216LN*BH	AJH234LN*BH	AJH252LN*BH	AJH252LN*BHA		
Unit 1 Unit 2 Unit 3			AJH072LN*BH	AJH090LN*BH	AJH108LN*BH	AJH126LN*BH	AJH144LN*BH	AJH162LN*BH	AJH090LN*BH AJH090LN*BH	AJH126LN*BH AJH072LN*BH	AJH126LN*BH AJH090LN*BH	AJH144LN*BH AJH090LN*BH	AJH162LN*BH AJH090LN*BH	AJH126LN*BH AJH126LN*BH		
Maximum Connectable Indoor Unit			13	16	19	23	26	29	33	36	40	43	46	47		
Indoor unit connectable capacity		kW	11.2-29.1	14-36.4	16.8-43.5	20-52	22.5-58.5	25-65	28-72.8	31.2-81.1	34-88.4	36.5-94.9	39-101.4	40-104		
Power source			3N-400V, 50/60Hz													
T1 condition	Capacity	Cooling	kW	22.4	28.0	33.5	40.0	45.0	50.0	56.0	62.4	68.0	73.0	78.0	80.0	
		Heating	kW	25.0	31.5	37.5	45.0	50.0	50.0	63.0	70.0	76.5	81.5	81.5	90.0	
	Input power	Cooling	Btu/h	76600	95500	114300	136500	153500	170600	191000	212900	232000	249000	266100	273000	
		Heating	Btu/h	85300	107500	128000	155500	170600	170600	215000	238000	261000	278100	281000	307000	
	Current	Cooling	A	5.20	7.28	8.96	10.96	13.01	16.56	14.56	18.16	18.24	20.29	23.84	21.92	
		Heating	A	5.17	7.25	8.65	11.17	13.63	13.63	14.50	16.34	18.42	20.88	20.88	22.34	
	EER	Cooling	W/W	4.31	3.85	3.74	3.65	3.46	3.02	3.85	3.86	3.73	3.60	3.27	3.65	
			Heating	W/W	4.84	4.35	4.34	4.03	3.67	3.67	4.34	4.28	4.15	3.90	3.90	4.03
		COP	Cooling	Btu/h/W	14.7	13.1	12.8	12.5	11.8	10.3	13.1	13.2	12.7	12.3	11.2	12.5
			Heating	Btu/h/W	16.5	14.8	14.8	13.7	12.5	12.5	14.8	14.6	14.2	13.3	13.3	13.7
T3 condition	Capacity	Cooling	kW	20.2	25.2	28.5	32	35.1	35.2	50.4	52.2	57.2	60.3	64.0	64.0	
		Heating	kW	6.73	9.20	9.34	10.70	11.82	12.35	18.39	17.44	19.90	21.02	21.55	21.40	
	Input power	Cooling	A	10.8	14.5	14.7	16.9	18.6	19.2	-	-	-	-	-	-	
		Heating	A	3.00	2.74	3.05	2.99	2.97	2.85	2.74	2.99	2.87	2.87	2.80	2.99	
EER	Cooling	Btu/h/W	10.23	9.35	10.40	10.20	10.14	9.72	9.35	10.21	9.81	9.79	9.56	10.20		
Power factor		%	90	92	92	92	92	93	-	-	-	-	-	-		
Airflow rate	High	m³/h	11100	11100	13000	13000	13700	13700	11100*2	13000+11100	13000+11100	13700+11100	13700+11100	13000*2		
Sound pressure level	Cooling	dB	56	58	57	60	62	63	61	61	62	63	64	63		
	Heating	(A)	58	59	60	62	64	64	62	63	64	65	65	65		
External static pressure (Max)		Pa	82	82	82	82	82	82	82	82	82	82	82	82		
Compressor motor output		kW	7.5	7.5	11	11	11	11	7.5*2	11.0+7.5	11.0+7.5	11.0+7.5	11.0+7.5	11.0+2		
Heat exchanger fin			Blue fin	Blue fin	Blue fin	Blue fin	Blue fin	Blue fin	Blue fin	Blue fin	Blue fin	Blue fin	Blue fin	Blue fin		
Dimensions	Height	mm	1690	1690	1690	1690	1690	1690	1690*2	1690*2	1690*2	1690*2	1690*2	1690*2		
	Width	mm	930	930	1240	1240	1240	1240	930*2	1240+930	1240+930	1240+930	1240+930	1240*2		
	Depth	mm	765	765	765	765	765	765	765*2	765*2	765*2	765*2	765*2	765*2		
Weight		kg	255	255	279	279	279	279	255*2	279+255	279+255	279+255	279+255	279+2		
Refrigerant	Type		R410A	R410A	R410A	R410A	R410A	R410A	R410A	R410A	R410A	R410A	R410A	R410A		
Connection pipe diameter	Factory changed amount	kg	11.7	11.7	11.8	11.8	11.8	11.8	11.7*2	11.8+11.7	11.8+11.7	11.8+11.7	11.8+11.7	11.8*2		
	Liquid	mm	12.70	12.70	12.70	12.70	12.70	15.88	15.88	15.88	15.88	15.88	15.88	15.88		
Operation range	Gas	mm	22.22	22.22	28.58	28.58	28.58	28.58	28.58	34.92	34.92	34.92	34.92	34.92		
	Cooling	°CDB	-15 to 52	-15 to 52	-15 to 52	-15 to 52	-15 to 52	-15 to 52	-15 to 52	-5 to 52	-5 to 52	-5 to 52	-5 to 52	-5 to 52		
Operation range	Heating	°CDB	-20 to 21	-20 to 21	-20 to 21	-20 to 21	-20 to 21	-20 to 21	-20 to 21	-20 to 21	-20 to 21	-20 to 21	-20 to 21	-20 to 21		

Energy efficiency combination

Rating Capacity range		HP	16	18	20	24	26	28	30	32		
Model name			AJH144LN*BHH	AJH162LN*BHH	AJH180LN*BHH	AJH216LN*BHH	AJH234LN*BHH	AJH252LN*BHH	AJH270LN*BHH	AJH288LN*BHH		
Unit 1 Unit 2 Unit 3			AJH072LN*BH AJH072LN*BH	AJH090LN*BH AJH072LN*BH	AJH108LN*BH AJH072LN*BH	AJH072LN*BH AJH072LN*BH AJH072LN*BH	AJH090LN*BH AJH072LN*BH AJH072LN*BH	AJH108LN*BH AJH072LN*BH AJH072LN*BH	AJH126LN*BH AJH072LN*BH AJH072LN*BH	AJH108LN*BH AJH090LN*BH AJH072LN*BH		
Maximum Connectable Indoor Unit			26	29	33	39	43	46	50	52		
Indoor unit connectable capacity		kW	22.4-58.2	25.2-65.5	28-72.6	33.6-87.3	36.4-94.6	39.2-101.7	42.4-110.2	44.7-116.2		
Power source			3N-400V, 50/60Hz									
T1 condition	Capacity	Cooling	kW	44.8	50.4	55.9	67.2	72.8	78.3	84.8	89.4	
		Heating	kW	50.0	56.5	62.5	75.0	81.5	87.5	95.0	100.0	
	Input power	Cooling	Btu/h	152800	171900	190700	229200	248300	267100	289300	305000	
		Heating	Btu/h	170600	192800	213300	255900	278100	298600	324100	341300	
	Current	Cooling	A	10.40	12.48	14.16	15.60	17.68	19.36	21.36	23.12	
		Heating	A	10.34	12.42	13.82	15.51	17.59	18.99	21.51	22.47	
	EER	Cooling	W/W	4.31	4.04	3.95	4.31	4.12	4.04	3.97	3.87	
			Heating	W/W	4.84	4.55	4.52	4.84	4.63	4.61	4.42	4.45
		COP	Cooling	Btu/h/W	14.7	13.8	13.5	14.7	14.0	13.8	13.5	13.2
			Heating	Btu/h/W	16.5	15.5	15.4	16.5	15.8	15.7	15.1	15.2
T3 condition	Capacity	Cooling	kW	40.4	45.4	48.7	60.6	65.6	68.9	72.4	77.2	
		Heating	kW	13.7800	154900	166100	206700	223800	235000	247000	263300	
	Input power	Cooling	A	13.47	15.93	16.08	20.20	22.66	22.81	24.17	25.42	
		Heating	A	-	-	-	-	-	-	-	-	
EER	Cooling	Btu/h/W	3.00	2.85	3.03	3.00	2.89	3.02	3.00	3.04		
Power factor		%	90	92	92	92	92	92	92	92		
Airflow rate	High	m³/h	11100*2	11100*2	13000+11100	11100*3	11100*3	13000+11100*2	13000+11100*2	13000*2+11100		
Sound pressure level	Cooling	dB	59	60	60	61	62	61	63	61		
	Heating	(A)	61	62	62	63	63	64	65	64		
External static pressure (Max)		Pa	82	82	82	82	82	82	82	82		
Compressor motor output		kW	7.5*2	7.5*2	11.0+7.5	7.5*3	7.5*3	11.0+7.5*2	11.0+7.5*2	11.0+2+7.5		
Heat exchanger fin			Blue fin	Blue fin	Blue fin	Blue fin	Blue fin	Blue fin	Blue fin	Blue fin		
Dimensions	Height	mm	1690*2	1690*2	1690*2	1690*3	1690*3	1690*3	1690*3	1690*3		
	Width	mm	1240*2	1240*2	1240+930	930*3	930*3	1240+930*2	1240+930*2	1240*2+930		
	Depth	mm	765*2	765*2	765*2	765*3	765*3	765*3	765*3	765*3		
Weight		kg	279*2	279*2	279+255	255*3	255*3	279+255*2	279+255*2	279*2+255		
Refrigerant	Type		R410A	R410A	R410A	R410A	R410A	R410A	R410A	R410A		
Connection pipe diameter	Factory changed amount	kg	11.7*2	11.7*2	11.8+11.7	11.7*3	11.7*3	11.8+11.7*2	11.8+11.7*2	11.8*2+11.7		
	Liquid	mm	12.70	15.88	15.88	15.88	15.88	15.88	19.05	19.05		
Operation range	Gas	mm	28.58	28.58	28.58	34.92	34.92	34.92	34.92	34.92		
	Cooling	°CDB	-5 to 46	-5 to 46	-5 to 46	-5 to 46	-5 to 46	-5 to 46	-5 to 46	-5 to 46		
Operation range	Heating	°CDB	-20 to 21	-20 to 21	-20 to 21	-20 to 21	-20 to 21	-20 to 21	-20 to 21	-20 to 21		

30	32	34*	36	36*	36	38*	38	40	42	44*	46*	48	50*	52*	54*
AJH270LN*BH	AJH288LN*BH	AJH306LN*BH	AJH306LN*BHA	AJH324LN*BH	AJH324LN*BHA	AJH342LN*BH	AJH342LN*BHA	AJH360LN*BH	AJH378LN*BH	AJH396LN*BH	AJH414LN*BH	AJH432LN*BH	AJH450LN*BH	AJH468LN*BH	AJH486LN*BH
AJH144LN*BH	AJH144LN*BH	AJH162LN*BH	AJH162LN*BH	AJH162LN*BH	AJH162LN*BH	AJH162LN*BH	AJH162LN*BH	AJH162LN*BH	AJH162LN*BH	AJH162LN*BH	AJH162LN*BH	AJH162LN*BH	AJH162LN*BH	AJH162LN*BH	AJH162LN*BH
50	53	55	55	55	55	55	55	55	55	55	55	55	55	55	55
42.5-110.5	45-117	47.5-123.5	48-124.8	50-130	50.5-131.3	53-137.8	54-140.4	56.5-146.9	59-153.4	61.5-159.9	64-166.4	67.5-175.5	70-182	72.5-188.5	75-195
3N - 400V, 50/60Hz															
85.0	90.0	95.0	96.0	100.0	101.0	106.0	108.0	113.0	118.0	123.0	128.0	135.0	140.0	145.0	150.0
95.0	100.0	100.0	108.0	100.0	113.0	113.0	121.5	126.5	131.5	131.5	131.5	150.0	150.0	150.0	150.0
29000	30700	324100	327500	341200	344500	361600	368500	385900	402500	419600	436700	460500	477600	494700	511800
324100	341200	341200	368500	341200	385600	385600	414500	431600	448700	448700	448700	511800	511800	511800	511800
23.97	26.02	29.57	25.52	33.12	27.57	31.12	29.20	31.25	33.30	36.85	40.40	39.03	42.58	46.13	49.68
24.80	27.26	27.26	25.67	27.26	28.13	28.13	29.59	32.05	34.51	34.51	34.51	40.89	40.89	40.89	40.89
-	-	-	-	-	-	-	-	-	-	-	-	-	-	-	-
3.55	3.46	3.21	3.76	3.02	3.66	3.41	3.70	3.62	3.54	3.34	3.17	3.46	3.29	3.14	3.02
3.83	3.67	3.67	4.21	3.67	4.02	4.02	4.11	3.95	3.81	3.81	3.81	3.67	3.67	3.67	3.67
12.1	11.8	11.0	12.8	10.3	12.5	11.6	12.6	12.3	12.1	11.4	10.8	11.8	11.2	10.7	10.3
13.1	12.5	12.5	14.4	12.5	13.7	13.7	14.0	13.5	13.0	13.0	13.0	12.5	12.5	12.5	12.5
67.1	70.2	70.3	82.4	70.4	85.5	85.6	89.2	92.3	95.4	95.5	95.6	105.3	105.4	105.5	105.6
22900	23960	23990	281200	240200	291800	292100	304400	315000	325600	325900	326200	359400	359700	360000	360300
22.52	23.64	24.17	29.10	24.70	30.21	30.75	30.60	31.72	32.83	33.37	33.90	35.45	35.99	36.52	37.05
2.98	2.97	2.91	2.83	2.85	2.83	2.78	2.91	2.91	2.91	2.86	2.82	2.97	2.93	2.89	2.85
10.17	10.14	9.93	9.66	9.72	9.66	9.50	9.95	9.93	9.92	9.77	9.62	10.14	10.00	9.86	9.72
-	-	-	-	-	-	-	-	-	-	-	-	-	-	-	-
13700+13000	13700+2	13700+2	13000+1100+2	13700+2	13700+1100+2	13700+1100+2	13000+2+1100+2	13000+13000+1100+2	13700+2+1100	13700+2+1100	13700+2+1100	13700+2+1100	13700+3	13700+3	13700+3
66	65	66	64	66	65	65	64	65	66	66	67	67	67	67	68
66	67	67	65	67	66	66	66	67	68	68	69	69	69	69	69
82	82	82	82	82	82	82	82	82	82	82	82	82	82	82	82
11.0+2	11.0+2	11.0+2	11.0+7.5+2	11.0+2	11.0+7.5+2	11.0+7.5+2	11.0+7.5+2	11.0+2+7.5	11.0+2+7.5	11.0+2+7.5	11.0+2+7.5	11.0+3	11.0+3	11.0+3	11.0+3
Blue fin	Blue fin	Blue fin	Blue fin	Blue fin	Blue fin	Blue fin	Blue fin	Blue fin	Blue fin	Blue fin	Blue fin	Blue fin	Blue fin	Blue fin	Blue fin
1690+2	1690+2	1690+2	1690+3	1690+2	1690+3	1690+3	1690+3	1690+3	1690+3	1690+3	1690+3	1690+3	1690+3	1690+3	1690+3
1240+2	1240+2	1240+2	1240+930+2	1240+2	1240+930+2	1240+930+2	1240+2+930	1240+2+930	1240+2+930	1240+2+930	1240+2+930	1240+3	1240+3	1240+3	1240+3
765+2	765+2	765+2	765+3	765+2	765+3	765+3	765+3	765+3	765+3	765+3	765+3	765+3	765+3	765+3	765+3
279+2	279+2	279+2	279+255+2	279+2	279+255+2	279+255+2	279+2+255	279+2+255	279+2+255	279+2+255	279+2+255	279+3	279+3	279+3	279+3
R410A	R410A	R410A	R410A	R410A	R410A	R410A	R410A	R410A	R410A	R410A	R410A	R410A	R410A	R410A	R410A
11.8+2	11.8+2	11.8+2	11.8+11.7+2	11.8+2	11.8+11.7+2	11.8+11.7+2	11.8+2+11.7	11.8+2+11.7	11.8+2+11.7	11.8+2+11.7	11.8+2+11.7	11.8+3	11.8+3	11.8+3	11.8+3
19.05	19.05	19.05	19.05	19.05	19.05	19.05	19.05	19.05	19.05	19.05	19.05	19.05	19.05	19.05	19.05
34.92	34.92	34.92	34.92	41.27	41.27	41.27	41.27	41.27	41.27	41.27	41.27	41.27	41.27	41.27	41.27
-5 to 52	-5 to 52	-5 to 52	-5 to 52	-5 to 52	-5 to 52	-5 to 52	-5 to 52	-5 to 52	-5 to 52	-5 to 52	-5 to 52	-5 to 52	-5 to 52	-5 to 52	-5 to 52
-20 to 21	-20 to 21	-20 to 21	-20 to 21	-20 to 21	-20 to 21	-20 to 21	-20 to 21	-20 to 21	-20 to 21	-20 to 21	-20 to 21	-20 to 21	-20 to 21	-20 to 21	-20 to 21

AJH__LN*: AJH__LNL, AJH__LNT *: Not available for sale in some regions.

34	36	38	40	42	44	46
AJH306LN*BHH	AJH324LN*BHH	AJH342LN*BHH	AJH360LN*BHH	AJH378LN*BHH	AJH396LN*BHH	AJH414LN*BHH
AJH126LN*BH	AJH108LN*BH	AJH108LN*BH	AJH126LN*BH	AJH126LN*BH	AJH126LN*BH	AJH126LN*BH
AJH108LN*BH	AJH108LN*BH	AJH108LN*BH	AJH108LN*BH	AJH108LN*BH	AJH108LN*BH	AJH108LN*BH
AJH072LN*BH	AJH108LN*BH	AJH108LN*BH	AJH108LN*BH	AJH126LN*BH	AJH126LN*BH	AJH126LN*BH
55	55	55	55	55	55	55
48-124.6	50.3-130.6	53.5-139.1	56.8-147.5	60-156	62.5-162.5	65-169
3N - 400V, 50/60Hz						
95.9	100.5	107.0	113.5	120.0	125.0	130.0
107.5	112.5	120.0	127.5	135.0	140.0	145.0
327200	342900	365100	387300	409500	426500	443500
366800	384000	409500	435000	460500	477600	494700
25.12	26.88	28.88	30.88	32.88	34.93	36.98
24.99	25.95	28.47	30.99	33.51	35.97	38.43
-	-	-	-	-	-	-
3.82	3.74	3.70	3.68	3.65	3.58	3.52
4.30	4.34	4.21	4.11	4.03	3.89	3.77
13.0	12.8	12.6	12.5	12.5	12.2	12.0
14.7	14.8	14.4	14.0	13.7	13.3	12.9
80.7	85.5	89.0	92.5	96.0	99.1	102.2
275300	291600	303600	315600	327600	338200	348800
26.78	28.03	29.39	30.75	32.11	33.22	34.34
-	-	-	-	-	-	-
3.01	3.05	3.03	3.01	2.99	2.98	2.98
10.28	10.40	10.33	10.26	10.20	10.18	10.16
-	-	-	-	-	-	-
13000+2+1100	13000+3	13000+3	13000+3	13000+3	13700+13000+2	13700+2+13000
63	64	64	64	65	66	66
65	66	66	66	67	68	68
82	82	82	82	82	82	82
11.0+2+7.5	11.0+3	11.0+3	11.0+3	11.0+3	11.0+3	11.0+3
Blue fin	Blue fin	Blue fin	Blue fin	Blue fin	Blue fin	Blue fin
1690+3	1690+3	1690+3	1690+3	1690+3	1690+3	1690+3
1240+2+930	1240+3	1240+3	1240+3	1240+3	1240+3	1240+3
765+3	765+3	765+3	765+3	765+3	765+3	765+3
279+2+255	279+3	279+3	279+3	279+3	279+3	279+3
R410A	R410A	R410A	R410A	R410A	R410A	R410A
11.8+2+11.7	11.8+3	11.8+3	11.8+3	11.8+3	11.8+3	11.8+3
19.05	19.05	19.05	19.05	19.05	19.05	19.05
34.92	41.27	41.27	41.27	41.27	41.27	41.27
-5 to 46	-5 to 46	-5 to 46	-5 to 46	-5 to 46	-5 to 46	-5 to 46
-20 to 21	-20 to 21	-20 to 21	-20 to 21	-20 to 21	-20 to 21	-20 to 21

Note: Specifications are based on the following conditions.

Cooling(T1): Indoor temperature of 27°CDB / 19°CWB, and outdoor temperature of 35°CDB / 24°CWB

Cooling(T3): Indoor temperature of 29°CDB / 19°CWB, and outdoor temperature of 46°CDB / 24°CWB

Heating: Indoor temperature of 20°CDB / (15°CWB), and outdoor temperature of 7°CDB / 6°CWB















































Pipe length: 7.5m. Height difference between outdoor and indoor unit: 0m.

AJH__LN*: AJH__LNL, AJH__LNT

INDOOR UNITS LINEUP

Comprehensive range of indoor units of variety design and capacity ranges available which can be selected to suit any air conditioning needs.

12 types, 84 models, Capacity range from 2.2 kW to 28.0 kW

Model code		7	9	12	14	18	24	
Capacity range (kW)		2.2	2.8	3.6	4.5	5.6	7.1	
Cassette	Compact Cassette	 AUXB07GALH AUXB07GATH	 AUXB09GALH AUXB09GATH	 AUXB12GALH AUXB12GATH	 AUXB14GALH AUXB14GATH	 AUXB18GALH AUXB18GATH	 AUXB24GALH AUXB24GATH	
	Cassette	Slim type					 AUXD18GALH AUXD18GATH	 AUXD24GALH AUXD24GATH
		Large type					 AUXA18GALH	 AUXA24GALH
Duct	Mini Duct (With drain pump)	NEW  ARXK07GCLH	NEW  ARXK09GCLH	NEW  ARXK12GCLH	NEW  ARXK14GCLH	NEW  ARXK18GCLH	NEW  ARXK24GCLH	
	Mini Duct (Without drain pump)	NEW  ARXK07GALH	NEW  ARXK09GALH	NEW  ARXK12GALH	NEW  ARXK14GALH	NEW  ARXK18GALH	NEW  ARXK24GALH	
	Slim Duct / Slim Concealed Floor	 ARXD07GALH ARXD07GATH ARXD07LATH*	 ARXD09GALH ARXD09GATH ARXD09LATH*	 ARXD12GALH ARXD12GATH ARXD12LATH*	 ARXD14GALH ARXD14GATH ARXD14LATH*	 ARXD18GALH ARXD18GATH ARXD18LATH*	 ARXD24GALH ARXD24GATH ARXD24LATH*	
	Low Static Pressure Duct						 ARXB24LATH*	
	Medium Static Pressure Duct						 ARXA24GBLH ARXA24GBTH ARXA24LATH*	
	High Static Pressure Duct							
	Large airflow duct					 ARXN18GATH	 ARXN24GATH	
Ceiling	Ceiling			 ABHA12GATH	 ABHA14GATH	 ABHA18GATH	 ABHA24GATH	
Wall Mounted	Wall Mounted	 ASHA07GACH ASHA07GATH	 ASHA09GACH ASHA09GATH	 ASHA12GACH ASHA12GATH	 ASHA14GACH ASHA14GATH	 ASHA18GACH ASHA18GATH	 ASHA24GACH ASHA24GATH	
	Wall Mounted (EEV external)	 ASHE07GACH	 ASHE09GACH	 ASHE12GACH	 ASHE14GACH	With this model, connection of EV kit is necessary.		

Energy Recovery Ventilator range

Airflow rate (m ³ /h)	250	350	500	800	1000
Model code	025	035	050	080	100
Energy Recovery Ventilator	 UTZ-BD025B	 UTZ-BD035B	 UTZ-BD050B	 UTZ-BD080B	 UTZ-BD100B

	30	34	36	45	54	60	72	90	96
	9.0	10.0	11.2	12.5	14.0	18.0	22.4	25.0	28.0
	 AUXA30GALH AUXA30GATH	 AUXA34GALH	 AUXA36GALH AUXA36GATH	 AUXA45GALH AUXA45GATH	 AUXA54GALH AUXA54GATH				
	 ARXB30LATH*		 ARXB36LATH*	 ARXB45LATH*					
	 ARXA30GBLH ARXA24GBTH ARXA30LATH*		 ARXA36GBLH ARXA36GBTH ARXA36LATH*	 ARXA45GBLH ARXA45GBTH ARXA45LATH*					
			 ARXC36GBTH				 ARXC72GBTH	 ARXC90GBTH	 ARXC96GBTH
				 ARXC45GATH		 ARXC60GATH	 ARXC72GATH	 ARXC90GATH	
	 ARXN30GATH	 ARXN34GATH	 ARXN36GATH	 ARXN45GATH					
	 ABHA30GATH		 ABHA36GATH	 ABHA45GATH	 ABHA54GATH				
	 ASHA30GATH ASHA30GATH								

*: stock only

Outdoor Air Unit range

Airflow rate (m³/h)	1080	1680	2100
Model code	054	072	096
Outdoor Air Unit	 ARXH054GTAH	 ARXH072GTAH	 ARXH096GTAH

Compact Cassette

Models

AUXB07GALH
 AUXB09GALH
 AUXB12GALH
 AUXB14GALH
 AUXB18GALH
 AUXB24GALH

Models

AUXB07GATH
 AUXB09GATH
 AUXB12GATH
 AUXB14GATH
 AUXB18GATH
 AUXB24GATH



Feature

2-stage turbo fan

High efficiency design by 2 stage structure

An evenly spread air distribution across the heat exchanger is possible due to the new 2 stage turbo fan which produces two separate airflow streams.

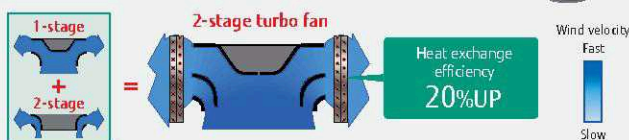

Previous turbo fan

In the case of a previous fan, the air outlet range was narrow as the airflow moved to the motor side which meant the velocity of air passing through the heat exchanger was uneven.



Quiet quality

Optimization of wing form (laminar wing type) and wing number (7 blades each)

Designed by CFD-analysis (fluid) simulations

Adoption of laminar wing



Improvement of the airflow distribution

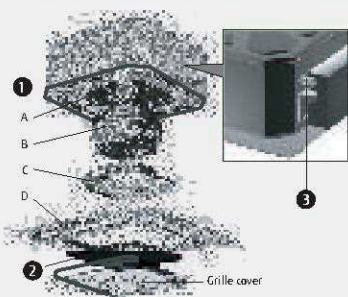

1 Maintenance of fan motor and fan

Maintenance of the fan motor and fan can be done easily after taking off the panel as the bell mouth of the fan can be removed easily.

- A : Fan motor B : 2-stage turbo fan
- C : Bell-mouth D : Panel

2 Air filter : standard equipment

3 Adaptation of transparent drainage parts

During installation, maintenance and operation, the drain pump and kit can be checked easily.

High ceiling mode

The compact cassette can be installed up to a height of 3.0m (12/14/18/24).

Model code	The maximum height from floor to ceiling (m)	
	Standard mode	High ceiling mode
07	2.7	—
09	2.7	—
12	2.7	3.0
14	2.7	3.0
18	2.7	3.0
24	2.7	3.0



Feature

Compact design

World's first 24,000Btu model in the compact cassette category
(Easy installation by taking off ceiling panel of 600 x 600 size)



High lift drain pump

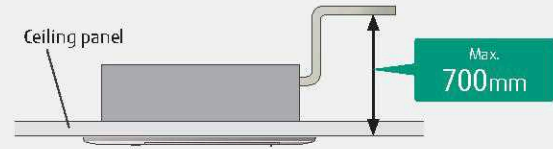

Optional parts

Air Outlet Shutter Plate : UTR-YDZB
Insulation Kit for High Humidity : UTZ-KXGC

Specifications

Model name		AUXB07GALH AUXB07GATH	AUXB09GALH AUXB09GATH	AUXB12GALH AUXB12GATH	AUXB14GALH AUXB14GATH	AUXB18GALH AUXB18GATH	AUXB24GALH AUXB24GATH	
Power source		Single-phase, ~230V, 50Hz						
Capacity	Cooling	kW	2.2	2.8	3.6	4.5	5.6	7.1
	Heating		2.8	3.2	4.1	5.0	6.3	8.0
Input power		W	25	25	29	35	36	84
Airflow rate	High	m ³ /h (l/s)	540 (150)	550 (153)	600 (167)	680 (189)	710 (197)	1,030 (286)
	Med		450 (125)	450 (125)	530 (147)	590 (164)	580 (161)	830 (231)
	Low		350 (97)	350 (97)	390 (108)	390 (108)	400 (111)	450 (125)
Sound pressure level	High	dB(A)	34	35	37	38	41	50
	Med		30	30	34	34	35	44
	Low		25	25	27	27	27	30
Dimensions (H x W x D)		mm	245 x 570 x 570	245 x 570 x 570	245 x 570 x 570	245 x 570 x 570	245 x 570 x 570	245 x 570 x 570
Weight		kg(lbs)	15 (33)	15 (33)	15 (33)	15 (33)	17 (37)	17 (37)
Connection pipe diameter	Liquid (Flare)	mm	6.35	6.35	6.35	6.35	9.52	9.52
	Gas (Flare)		12.70	12.70	12.70	12.70	15.88	15.88
Drain hose diameter (I.D./O.U.)			25 / 32					
Cassette		Model name	UTG-UFGC-W					
Grille	Dimensions (HxWxD)	mm	50 x 700 x 700					
	Weight	kg(lbs)	2.6 (6)					

Note : Specifications are based on the following conditions.

Cooling : Indoor temperature of 27°CDB / 19°CWB, and outdoor temperature of 35°CDB / 24°CWB.

Heating : Indoor temperature of 20°CDB / (15°CWB), and outdoor temperature of 7°CDB / 6°CWB.

Pipe length : 7.5 m; Height difference between outdoor unit and indoor unit : 0 m. Voltage : 230 [V].

Dimensions (Unit : mm)

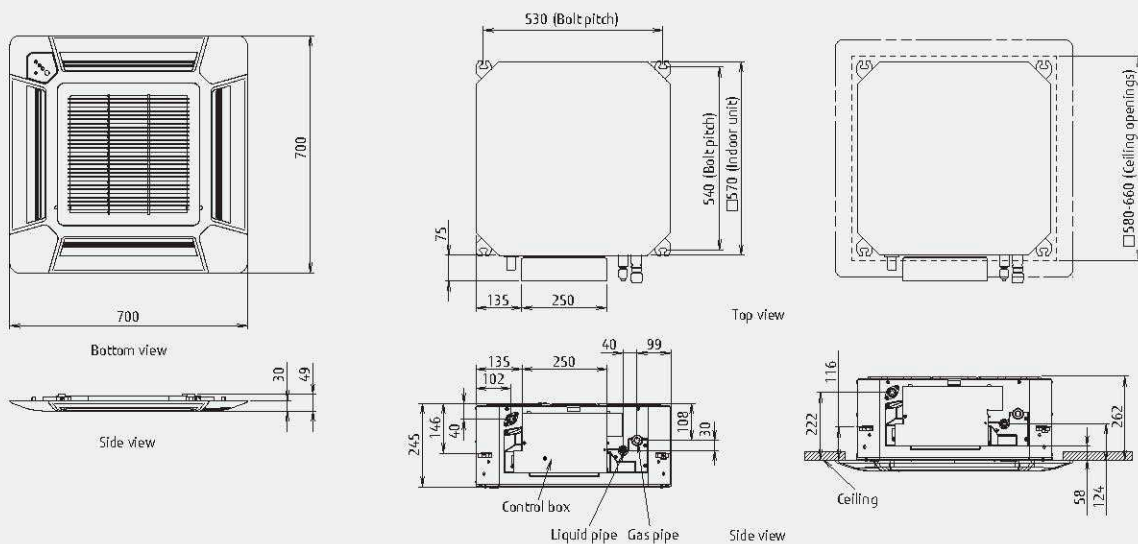

Cassette (Slim type)

Models

AUXD18GALH
AUXD24GALH

Models

AUXD18GATH
AUXD24GATH



Feature

High efficiency turbo fan with 3-dimensional blade

High efficiency airflow distribution has been achieved by the introduction of a 3 dimensional blade which increases the air passing over the heat exchanger.

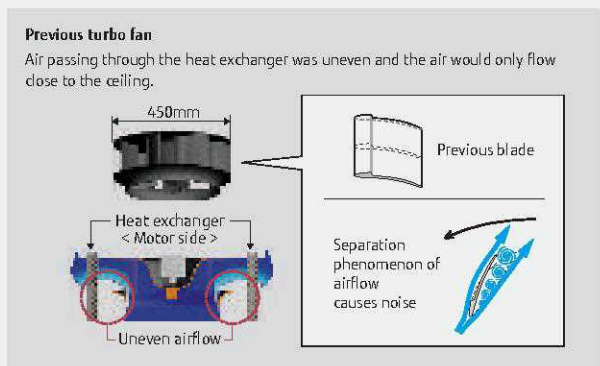
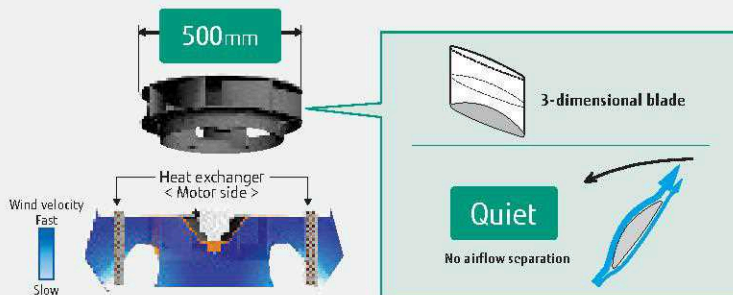

← : Spin direction → : Airflow direction ●●●● : Turbulent flow noise

Improvement of the airflow distribution

The louvre design distributes air leaving a space between the chassis and the ceiling allowing far and wide air flow distribution.

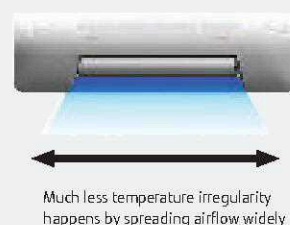
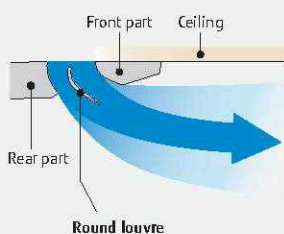
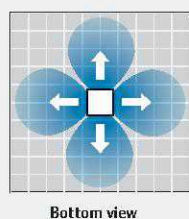

Adjustment of hanger position is possible after installation

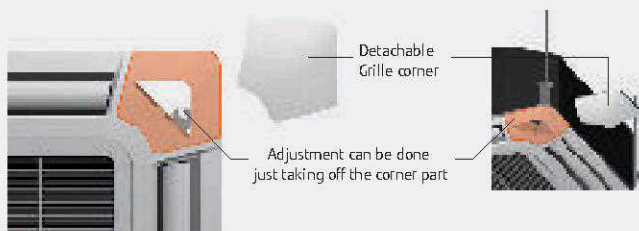

High ceiling mode

This cassette can be installed up to a height of 3.5m.

Model code	The maximum height from floor to ceiling (m)	
	Standard mode	High ceiling mode
18	3.0	3.5
24	3.0	3.5

Feature

One way installation

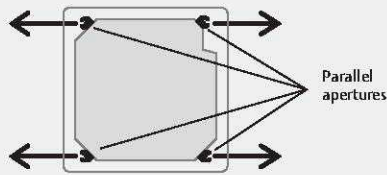

High lift drain pump

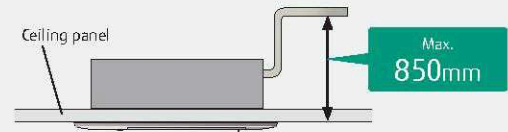

Optional parts

IR Receiver Unit :	UTY-LRHGB1
Air Outlet Shutter Plate :	UTR-YDZK
Panel Spacer :	UTG-BKXA-W
Insulation Kit for High Humidity :	UTZ-KXRA
Wide Panel :	UTG-AKXA-W

Specifications

Model name		AUXD18GALH AUXD18GATH	AUXD24GALH AUXD24GATH
Power source		Single - phase, ~230V, 50Hz	
Capacity	Cooling	5.6	7.1
	Heating	6.3	8.0
Input power		39	46
Airflow rate	High	1,150 (319)	1,280 (356)
	Med	940 (261)	1,040 (289)
	Low	870 (242)	870 (242)
Sound pressure level	High	36	38
	Med	30	33
	Low	29	29
Dimensions (H x W x D)		246 x 840 x 840	246 x 840 x 840
Weight		22 (48)	22 (48)
Connection pipe diameter	Liquid (Flare)	9.52	9.52
	Gas (Flare)	15.88	15.88
Drain hose diameter (I.D./O.U.)		25 / 32	
Cassette	Model name	UTG-UGGA-W	
Grille	Dimensions (HxWxD)	50 x 950 x 950	
	Weight	5.5 (12)	

Note : Specifications are based on the following conditions.

Cooling : Indoor temperature of 27°CDB / 19°CWB, and outdoor temperature of 35°CDB / 24°CWB.

Heating : Indoor temperature of 20°CDB / (15°CWB), and outdoor temperature of 7°CDB / 6°CWB.

Pipe length : 7.5 m; Height difference between outdoor unit and indoor unit : 0 m. Voltage : 230 [V].

Dimensions (Unit : mm)

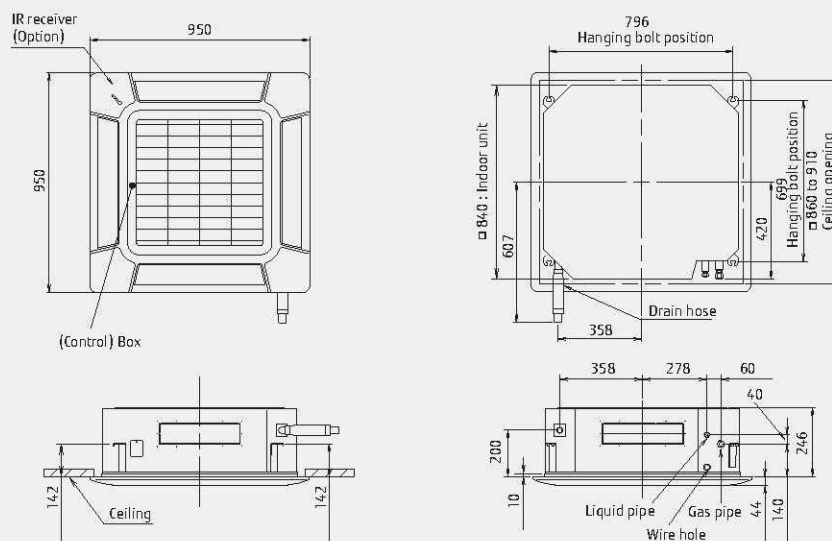

Cassette (Large type)

Models

AUXA18GALH
 AUXA24GALH
 AUXA30GALH
 AUXA34GALH
 AUXA36GALH
 AUXA45GALH
 AUXA54GALH

Models

AUXA30GATH
 AUXA36GATH
 AUXA45GATH
 AUXA54GATH



Feature

High efficiency turbo fan with 3-dimensional blade

High efficiency airflow distribution has been achieved by the introduction of a 3 dimensional blade which increases the air passing over the heat exchanger.

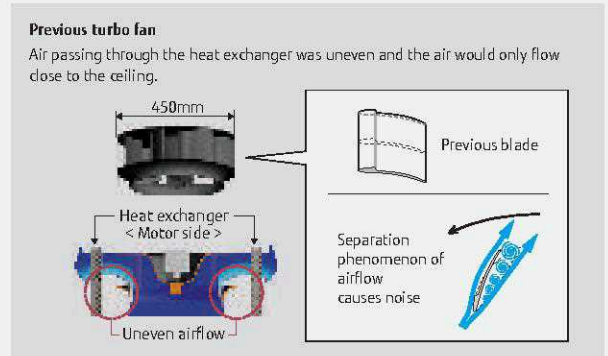
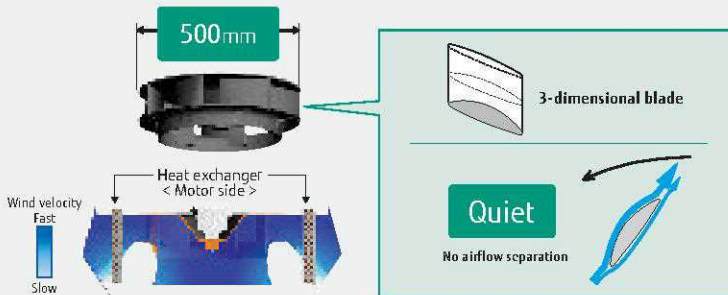

← : Spin direction → : Airflow direction ●●●●● : Turbulent flow noise

Improvement of the airflow distribution

The louvre design distributes air leaving a space between the chassis and the ceiling allowing far and wide air flow distribution.

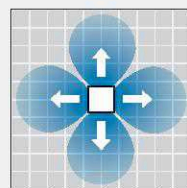

Bottom view

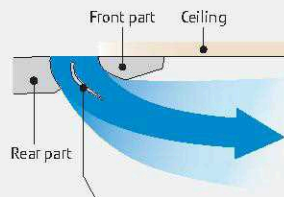

Round louvre



Much less temperature irregularity happens by spreading airflow widely

Adjustment of hanger position is possible after installation

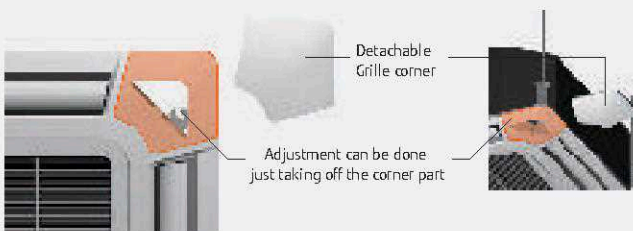

High ceiling mode

This cassette can be installed up to a height of 4.2m (36/45/54).

Model code	The maximum height from floor to ceiling (m)	
	Standard mode	High ceiling mode
18	3.0	3.5
24	3.0	3.5
30	3.2	3.6
34	3.2	3.6
36	3.2	4.2
45	3.2	4.2
54	3.2	4.2

Feature

One way installation

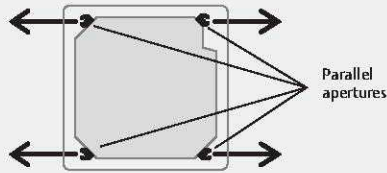

High lift drain pump

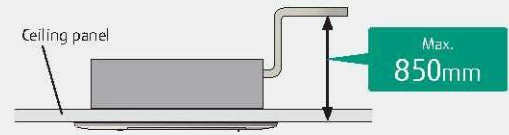

Optional parts

IR Receiver Unit :	UTY-LRHGB1
Air Outlet Shutter Plate :	UTR-YDZK
Panel Spacer :	UTG-BKXA-W
Insulation Kit for High Humidity :	UTZ-KXRA
Wide Panel :	UTG-AKXA-W

Specifications

Model name		AUXA18GALH	AUXA24GALH	AUXA30GALH AUXA30GATH	AUXA36GALH	AUXA36GALH AUXA36GATH	AUXA45GALH AUXA45GATH	AUXA54GALH AUXA54GATH	
Power source		Single - phase, ~230V, 50Hz							
Capacity	Cooling	kW	5.6	7.1	9.0	10.0	11.2	12.5	14.0
	Heating	kW	6.3	8.0	10.0	11.2	12.5	14.0	16.0
Input power		W	51	51	59	77	80	99	119
Airflow rate	High	m ³ /h (l/s)	1,420 (394)	1,420 (394)	1,600 (444)	1,750 (486)	1,800 (500)	1,900 (528)	2,000 (556)
	Med	m ³ /h (l/s)	1,230 (342)	1,230 (342)	1,300 (361)	1,300 (361)	1,300 (361)	1,370 (381)	1,370 (381)
	Low	m ³ /h (l/s)	1,100/1,000*1 (306/278)	1,100/1,000*1 (306/278)	1,100 (306)	1,100 (306)	1,100 (306)	1,100 (306)	1,100 (306)
Sound pressure level	High	dB(A)	40	40	40	43	44	46	47
	Med	dB(A)	36	36	38	38	38	39	39
	Low	dB(A)	33/31*1	33/31*1	33	33	33	33	33
Dimensions (H x W x D)		mm	288 x 840 x 840	288 x 840 x 840	288 x 840 x 840	288 x 840 x 840	288 x 840 x 840	288 x 840 x 840	288 x 840 x 840
Weight		kg(lbs)	27 (59)	27 (59)	27 (59)	27 (59)	27 (59)	27 (59)	27 (59)
Connection pipe diameter	Liquid (Flare)	mm	9.52	9.52	9.52	9.52	9.52	9.52	9.52
	Gas (Flare)	mm	15.88	15.88	15.88	15.88	19.05	19.05	19.05
Drain hose diameter (I.D./O.U.)			25 / 32						
Cassette	Model name		UTG-UGGA-W						
Grille	Dimensions (HxWxD)	mm	50 x 950 x 950						
	Weight	kg(lbs)	5.5 (12)						

Note : Specifications are based on the following conditions.
*1: This value is "cooling operation / heating operation".

Cooling : Indoor temperature of 27°CDB / 19°CWB, and outdoor temperature of 35°CDB / 24°CWB.
Heating : Indoor temperature of 20°CDB / (15°CWB), and outdoor temperature of 7°CDB / 6°CWB.
Pipe length : 7.5 m; Height difference between outdoor unit and indoor unit : 0 m. Voltage : 230 [V].

Dimensions (Unit : mm)

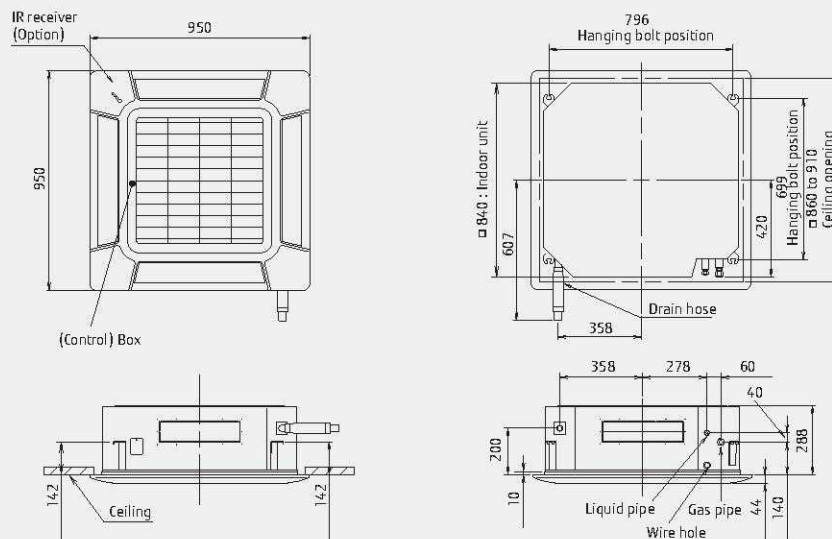

Mini Duct

Models (With drain pump)

- ARXK07GCLH **NEW**
- ARXK09GCLH **NEW**
- ARXK12GCLH **NEW**
- ARXK14GCLH **NEW**
- ARXK18GCLH **NEW**
- ARXK24GCLH **NEW**



Models (Without drain pump)

- ARXK07GALH **NEW**
- ARXK09GALH **NEW**
- ARXK12GALH **NEW**
- ARXK14GALH **NEW**
- ARXK18GALH **NEW**
- ARXK24GALH **NEW**



Feature

Optimum design in harmony with interior decoration

Thin and short-depth body makes the clipped ceiling design simple.

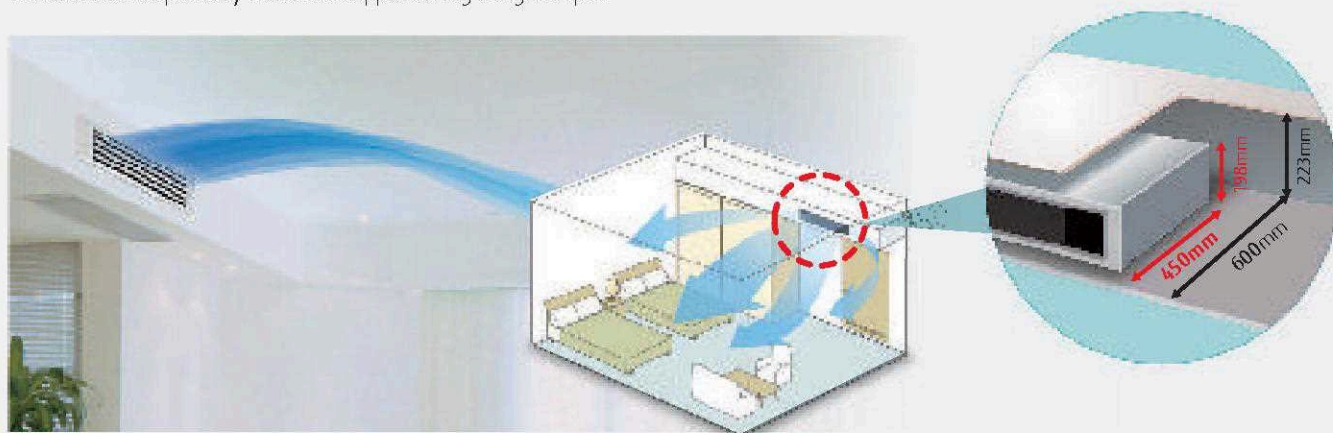

Advanced performance by new shaped heat exchanger and airflow

Air blower is improved so that velocity distribution is optimum in accordance with the heat exchanger shape. Wide range and uniform airflow can be received due to heat exchanger.

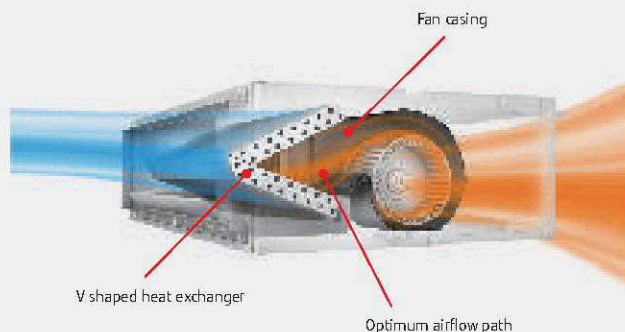

Easy drain design even at narrow ceiling

Models with drain pump: Drainage to the distant drain port is possible.
Models without drain pump: Both sides drainage is possible.

Models with drain pump

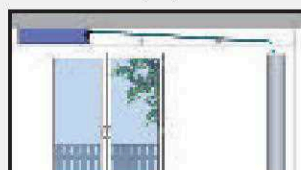

For models with drain pump, drain design is easy even at narrow ceiling.

Models without drain pump

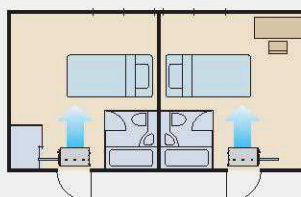

For models without drain pump, both sides drainage is possible and drain design is easy.

Feature

6-speed control*

Multistep airflow speed control allows this model to install in a quiet location.

Low noise
21 dB(A)

at 07 / 09 models

6-Step Speed



* Compatible Remote Controller is as follows:

UTY-RNRGZ1 / UTY-RLRG / UTY-DCGG / UTY-DTGGZ1 / UTY-ALGX / UTY-APGX

Optional parts

Remote Sensor Unit : UTY-XSZX
 IR Receiver Unit : UTB-YWC
 Auto Louver Grille Kit : UTD-GXTA-W (for ARXX07/09/12/14GCLH
 ARXX07/09/12/14GALH)
 UTD-GXTB-W (for ARXX18GCLH
 ARXX18GALH)
 UTD-GXTC-W (for ARXX24GCLH
 ARXX24GALH)

Specifications

Model name	ARXX07GCLH ARXX07GALH	ARXX09GCLH ARXX09GALH	ARXX12GCLH ARXX12GALH	ARXX14GCLH ARXX14GALH	ARXX18GCLH ARXX18GALH	ARXX24GCLH ARXX24GALH	
Power source	Single-phase, ~230V, 50Hz						
Capacity	Cooling	2.2	2.8	3.6	4.5	5.6	
	Heating	2.8	3.2	4.0	5.0	6.3	
Input power	GCLH / GALH	28 / 21	28 / 21	35 / 28	66 / 59	73 / 66	
Airflow rate	High	460 (128)	460 (128)	550 (153)	760 (211)	930 (258)	
	Me-Hi	440 (122)	440 (122)	520 (144)	660 (183)	840 (233)	
	Med	420 (117)	420 (117)	480 (133)	560 (156)	740 (206)	
	Lo-Hi	400 (111)	400 (111)	450 (125)	490 (136)	640 (178)	
	Low	370 (103)	370 (103)	410 (114)	410 (114)	540 (150)	
	Quiet	340 (94)	340 (94)	340 (94)	340 (94)	470 (131)	
Static pressure range	Pa	0 to 30	0 to 30	0 to 30	0 to 50	0 to 50	
Standard static pressure	Pa	10	10	10	15	15	
Sound pressure level	High	26	26	29	34	33	
	Me-Hi	25	25	27	31	30	
	Med	24	24	26	28	28	
	Lo-Hi	23	23	25	26	26	
	Low	22	22	24	24	24	
Quiet	21	21	22	22	22		
Dimensions (H x W x D)	kg(lbs)	198 x 700 x 450	198 x 700 x 450	198 x 700 x 450	198 x 700 x 450	198 x 900 x 450	198 x 1,100 x 450
Weight	GCLH / GALH	15.5 (34) / 15 (33)	15.5 (34) / 15 (33)	16 (35) / 15.5 (34)	16 (35) / 15.5 (34)	19 (42) / 18.5 (41)	22.5 (50) / 22 (49)
Connection pipe diameter	Liquid (Flare)	6.35	6.35	6.35	6.35	9.52	9.52
	Gas (Flare)	12.70	12.70	12.70	12.70	15.88	15.88
Drain hose diameter (I.D./O.U.)		25 / 32					

Note : Specifications are based on the following conditions.

Cooling : Indoor temperature of 27°CDB / 19°CWB, and outdoor temperature of 35°CDB / 24°CWB.

Heating : Indoor temperature of 20°CDB / (15°CWB), and outdoor temperature of 7°CDB / 6°CWB.

Pipe length : 7.5 m; Height difference between outdoor unit and indoor unit : 0 m. Voltage : 230 [V].

Dimensions (Unit: mm)

*Models (With drain pump)

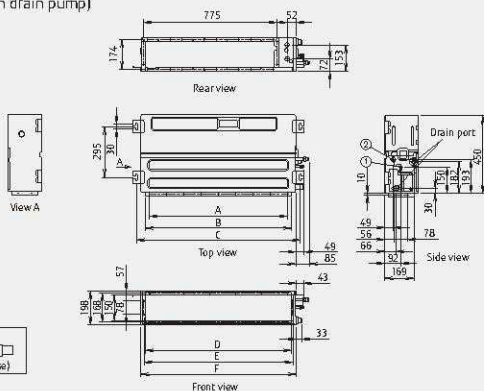

*Models (Without drain pump)

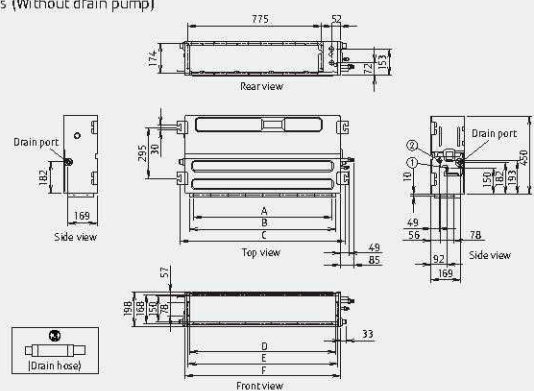

- ① Refrigerant pipe flare connection (Liquid)
- ② Refrigerant pipe flare connection (Gas)
- ③ Drain hose connection

	ARXX07-14	ARXX18	ARXX24
A	P100×6-600	P100×8-800	P100×10-1000
B	650	850	1050
C	752	952	1152
D	650	850	1050
E	665	864	1064
F	700	900	1100

- ① Refrigerant pipe flare connection (Liquid)
- ② Refrigerant pipe flare connection (Gas)
- ③ Drain hose connection

	ARXX07-14	ARXX18	ARXX24
A	P100×6-600	P100×8-800	P100×10-1000
B	650	850	1050
C	752	952	1152
D	650	850	1050
E	665	864	1064
F	700	900	1100

Slim Duct / Slim Concealed Floor

Models

ARXD07GALH
ARXD09GALH
ARXD12GALH
ARXD14GALH
ARXD18GALH
ARXD24GALH

Models

ARXD07GATH
ARXD09GATH
ARXD12GATH
ARXD14GATH
ARXD18GATH
ARXD24GATH

Models

ARXD07LATH*
ARXD09LATH*
ARXD12LATH*
ARXD14LATH*
ARXD18LATH*
ARXD24LATH*

*: Stock only



Slim Concealed Floor



Feature

Slim design

With a slim indoor design, this indoor can be installed in narrow ceiling spaces.

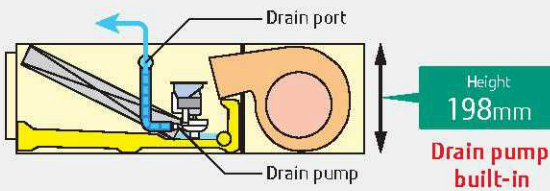

Air-intake

Air intake direction can be selected to match the installation site.

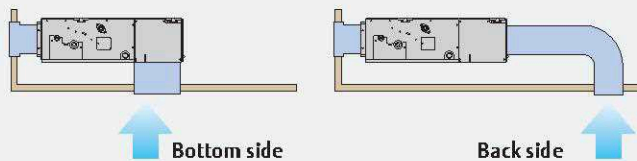

Selectable with a wide range of static pressure

By using DC fan motor, it is possible to change of static pressure range 0 to 90Pa. The change of static pressure range is possible by remote controller.



Static pressure range
0 to 90 Pa
*24 model is 0 to 50Pa

High lift drain pump

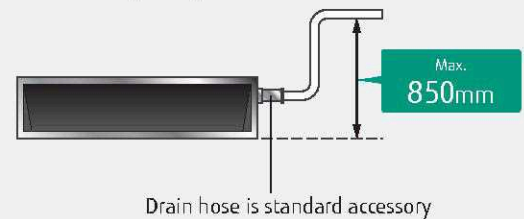

Filter (Accessory)

ARXD07 / 09 / 12 / 14 / 18

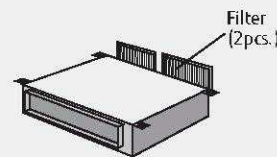

ARXD24

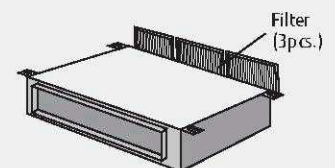

Flexible installation

Ceiling concealed

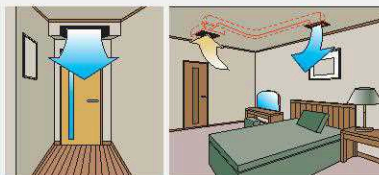

Floor concealed

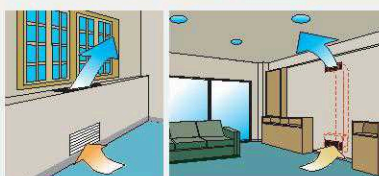

Feature

Auto Louver Grille Kit (Option)

Simple flat Auto Louver will provide comfort airflow and harmonize with luxury interior.

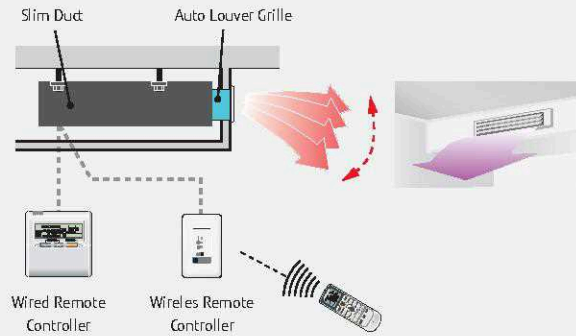

Optional parts

Remote Sensor Unit :	UTY-XSZX
IR Receiver Unit :	UTB-YWC
Auto Louver Grille Kit :	UTD-GXTA-W (for ARXD07/09/12/14GALH ARXD07/09/12/14GATH) ARXD07/09/12/14LATH*)
	UTD-GXTB-W (for ARXD18GALH ARXD18GATH) ARXD18LATH*)
	UTD-GXTC-W (for ARXD24GALH ARXD24GATH) ARXD24LATH*)

Specifications

Model name		ARXD07GALH ARXD07GATH ARXD07LATH*	ARXD09GALH ARXD09GATH ARXD09LATH*	ARXD12GALH ARXD12GATH ARXD12LATH*	ARXD14GALH ARXD14GATH ARXD14LATH*	ARXD18GALH ARXD18GATH ARXD18LATH*	ARXD24GALH ARXD24GATH ARXD24LATH*		
Power source		Single - phase, ~230V, 50Hz							
Capacity	Cooling	kW		2.2	2.8	3.6	4.5	5.6	7.1
	Heating	kW		2.8	3.2	4.0	5.0	6.3	8.0
Input power		W		44	50	54	92	83	122
Airflow rate	High	m ³ /h (l/s)		550 (153)	600 (167)	600 (167)	800 (222)	940 (261)	1,330 (369)
	Med	m ³ /h (l/s)		490 (136)	550 (153)	510 (142)	710 (197)	840 (233)	1,240 (344)
	Low	m ³ /h (l/s)		440 (122)	480 (133)	450 (125)	610 (169)	750 (208)	1,100 (306)
Static pressure range		Pa		0 to 90	0 to 90	0 to 90	0 to 90	0 to 90	0 to 50
Standard static pressure		Pa		25	25	25	25	25	25
Sound pressure level	High	dB(A)		28	29	30	34	34	35
	Med	dB(A)		25	26	27	32	32	32
	Low	dB(A)		22	24	24	28	28	29
Dimensions (H x W x D)		mm		198 x 700 x 620	198 x 700 x 620	198 x 700 x 620	198 x 700 x 620	198 x 900 x 620	198 x 1,100 x 620
Weight		kg(lbs)		17 (37)	17 (37)	18 (40)	18 (40)	22 (48)	26 (57)
Connection pipe diameter	Liquid (Flare)	mm		6.35	6.35	6.35	6.35	9.52	9.52
	Gas (Flare)	mm		12.70	12.70	12.70	12.70	15.88	15.88
Drain hose diameter (I.D./O.U.)				25 / 32					

Note : Specifications are based on the following conditions.

Cooling : Indoor temperature of 27°CDB / 19°CWB, and outdoor temperature of 35°CDB / 24°CWB.
 Heating : Indoor temperature of 20°CDB / (15°CWB), and outdoor temperature of 7°CDB / 6°CWB.
 Pipe length : 7.5 m; Height difference between outdoor unit and indoor unit : 0 m.

Dimensions (Unit : mm)

*Service accessibility must be allowed for when installing the product.

Please consult the installation manual for the necessary service access size.

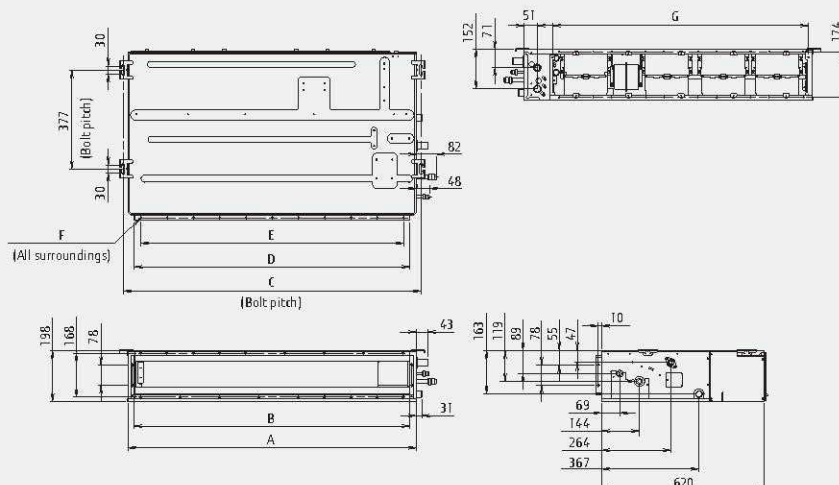

	ARXD07-14	ARXD18	ARXD24
A	700	900	1100
B	650	850	1050
C	734	934	1134
D	650	850	1050
E	P100x6=600	P100x8=800	P100x10=1000
F	18xØ5	22xØ5	26xØ5
G	574	774	974

Low Static Pressure Duct

Models

- ARXB24LATH*
- ARXB30LATH*
- ARXB36LATH*
- ARXB45LATH*

*: Stock only



Feature

Slim & Compact design

In the case of bottom return air connection, not only does the indoor unit design allow for installation in a narrow ceiling space of up to 270mm, Further space savings have been achieved by mounting the electrical control box internally inside the chassis.

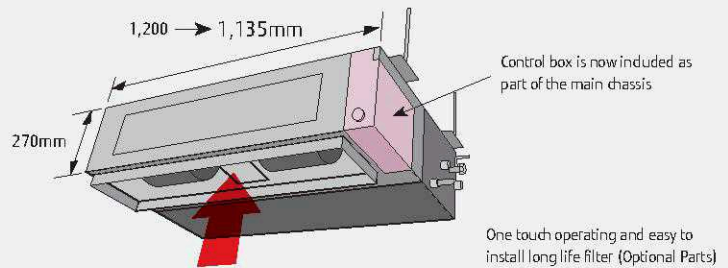

Line-up of low-noise and high-power models, compatible with a wide range of static pressure

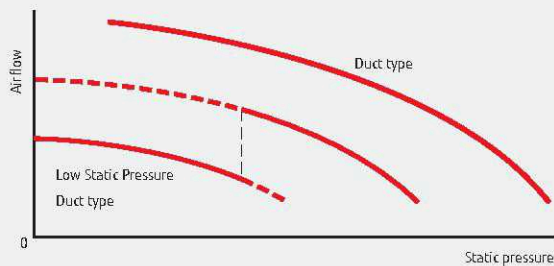

Low Static Pressure Duct type

Optimum model for hotels or bedrooms

An ultra low-noise model that achieves a quiet interior. Perfect for hotels or bedrooms with limited air duct installation space. Two different levels can be selected according to the static pressure range.

25 dB

ARXB24
Low

Duct type

Powerful model with a flexible design

With a powerful motor, appropriate for a wide range of static pressure. Flexible air duct installation is possible in a large space such as an office.

Max.

150 Pa

Easy maintenance

See below for the case of rear suction type

Previous model

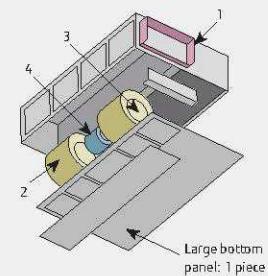

New model

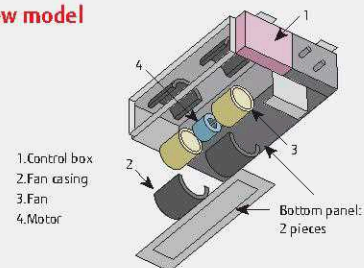

Structural improvement is attained by making the bottom panel two pieces, front and rear. The internal fan casing is also manufactured in two pieces, namely upper and lower. The maintenance of the motor and fan can be easily carried out by removing the rear panel and the lower part of the casing while leaving the main chassis installed.

Feature

Two-direction drain piping

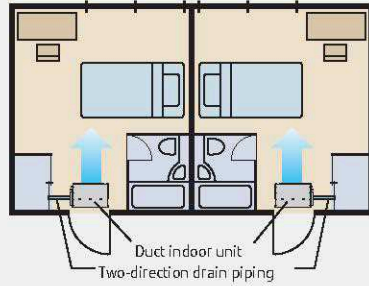

Installation styles

Embedded in Ceiling

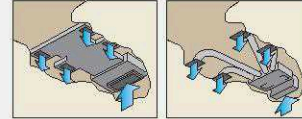

Hanging from Ceiling

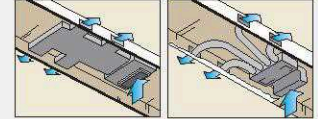

Optional parts

Remote Sensor Unit : UTY-XSZX	Flange (Round) :	UTD-RF204
Long Life Filter : UTD-LF25NA	IR Receiver Unit :	UTB-YWC
Flange (Square) : UTD-SF045T	Drain Pump Unit :	UTZ-PX1NBA

Specifications

Model name		ARXB24LATH	ARXB30LATH	ARXB36LATH	ARXB45LATH	
Power source		Single - phase, ~230V, 50Hz				
Capacity	Cooling	kW	7.1	9.0	11.2	12.5
	Heating	kW	8.0	10.0	12.5	14.0
Input power		W	145	198	253	338
Airflow rate	High	m ³ /h (l/s)	1,100 (306)	1,410 (392)	1,710 (475)	1,970 (547)
	Med	m ³ /h (l/s)	920 (256)	1,280 (356)	1,600 (444)	1,790 (497)
	Low	m ³ /h (l/s)	810 (225)	1,150 (319)	1,470 (408)	1,670 (464)
Static pressure range		Pa	0 to 80	0 to 80	0 to 80	0 to 80
Standard static pressure		Pa	40	50	50	60
Sound pressure level	High	dB(A)	31	34	37	41
	Med	dB(A)	27	32	35	38
	Low	dB(A)	25	29	33	36
Dimensions (H x W x D)		mm	270 × 1,135 × 700	270 × 1,135 × 700	270 × 1,135 × 700	270 × 1,135 × 700
Weight		kg(lbs)	39 (86)	42 (93)	42 (93)	42 (93)
Connection pipe diameter	Liquid (Flare)	mm	9.52	9.52	9.52	9.52
	Gas (Flare)	mm	15.88	15.88	19.05	19.05
Drain hose diameter (I.D./O.U.)			25 / 32			

Note : Specifications are based on the following conditions.

Cooling : Indoor temperature of 27°CDB / 19°CWB, and outdoor temperature of 35°CDB / 24°CWB.

Heating : Indoor temperature of 20°CDB / (15°CWB), and outdoor temperature of 7°CDB / 6°CWB.

Pipe length : 7.5 m; Height difference between outdoor unit and indoor unit : 0 m.

Dimensions (Unit : mm)

*Service accessibility must be allowed for when installing the product.

Please consult the installation manual for the necessary service access size.

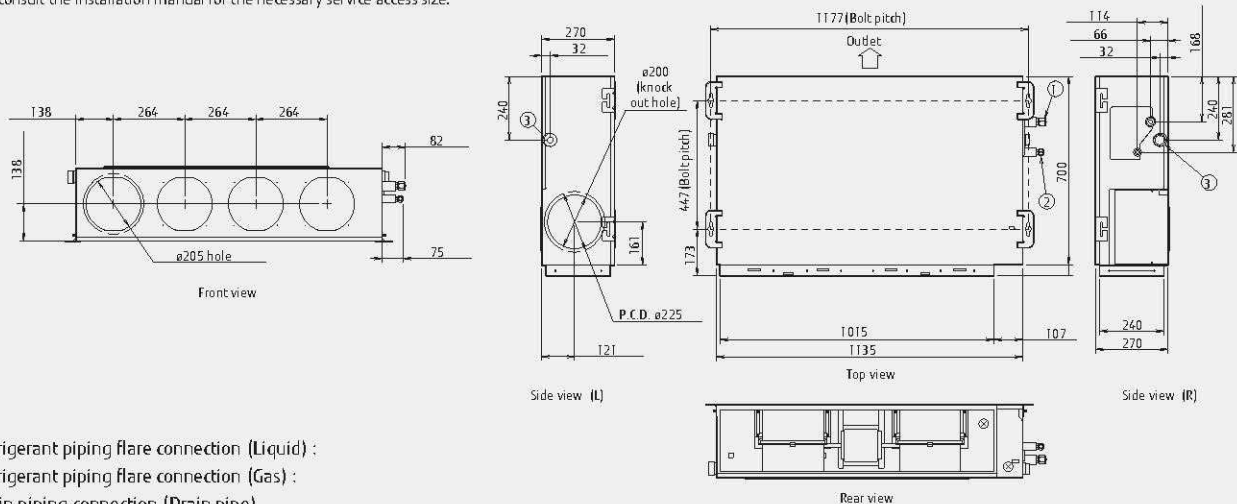

Medium Static Pressure Duct

Models

ARXA24GBLH
ARXA30GBLH
ARXA36GBLH
ARXA45GBLH

Models

ARXA24GBTH
ARXA30GBTH
ARXA36GBTH
ARXA45GBTH

Models

ARXA24LATH*
ARXA30LATH*
ARXA36LATH*
ARXA45LATH*

*: Stock only



Feature

Slim & Compact design

In the case of bottom return air connection, not only does the indoor unit design allow for installation in a narrow ceiling space of up to 270mm, Further space savings have been achieved by mounting the electrical control box internally inside the chassis.

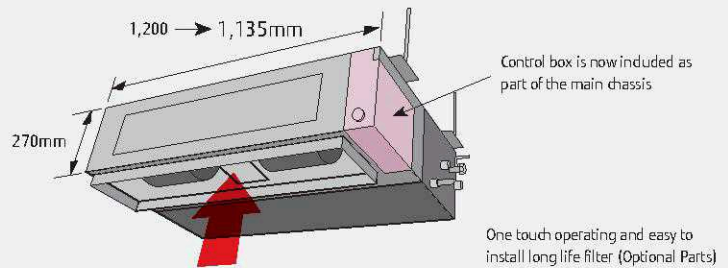

Selectable with a wide range of static pressure

It is possible to change of static pressure range 0 to 150Pa.

Static pressure range
0 to 150 Pa

Can be installed for various location

It can be installed in such locations as high-rise condominiums by low static pressure design.

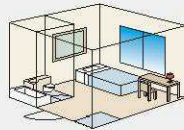

It can also be installed in wide spade when high static pressure is required, such as for offices.

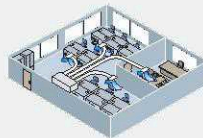

Easy setting by using remote controller

The change of static pressure range is possible by remote controller



Easy maintenance

See below for the case of rear suction type

Previous model

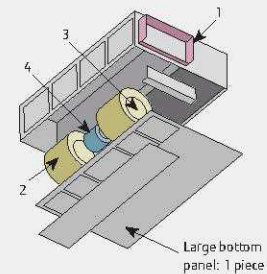

New model

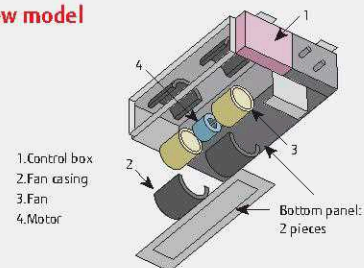

Structural improvement is attained by making the bottom panel two pieces, front and rear. The internal fan casing is also manufactured in two pieces, namely upper and lower. The maintenance of the motor and fan can be easily carried out by removing the rear panel and the lower part of the casing while leaving the main chassis installed.

Feature

Two-direction drain piping

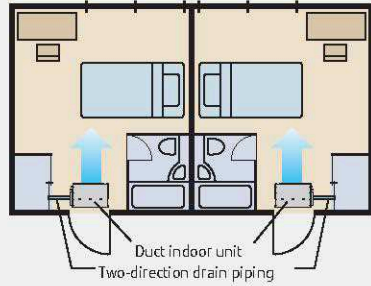

Installation styles

Embedded in Ceiling

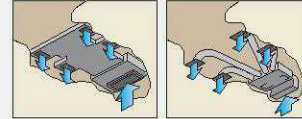

Hanging from Ceiling

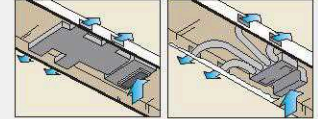

Optional parts

Remote Sensor Unit :	UTY-XSZX	Flange (Round) :	UTD-RF204
Long Life Filter :	UTD-LF25NA	IR Receiver Unit :	UTB-YWC
Flange (Square) :	UTD-SF045T	Drain Pump Unit :	UTZ-PX1NBA

Specifications

Model name	ARXA24GBLH ARXA24GBTH ARXA24LATH*	ARXA30GBLH ARXA30GBTH ARXA30LATH*	ARXA36GBLH ARXA36GBTH ARXA36LATH*	ARXA45GBLH ARXA45GBTH ARXA45LATH*	
Power source	Single - phase, ~230V, 50Hz				
Capacity	Cooling	7.1	9.0	11.2	12.5
	Heating	8.0	10.0	12.5	14.0
Input power	W	190	188	312	312
Airflow rate	High	1,280 (356)	1,280 (356)	1,720 (478)	1,720 (478)
	Med	1,210 (336)	1,210 (336)	1,670 (464)	1,670 (464)
	Low	1,130 (314)	1,130 (314)	1,600 (444)	1,600 (444)
Static pressure range	Pa	30 to 150	30 to 150	30 to 150	30 to 150
Standard static pressure		100	100	100	100
Sound pressure level	High	38	40	43	43
	Med	36	38	41	41
	Low	34	36	39	39
Dimensions (H x W x D)	mm	270 x 1,135 x 700	270 x 1,135 x 700	270 x 1,135 x 700	270 x 1,135 x 700
Weight	kg(lbs)	39 (86)	42 (93)	42 (93)	42 (93)
Connection pipe diameter	Liquid (Flare)	9.52	9.52	9.52	9.52
	Gas (Flare)	15.88	15.88	19.05	19.05
Drain hose diameter (I.D./O.U.)		25 / 32			

Note : Specifications are based on the following conditions.

Cooling : Indoor temperature of 27°CDB / 19°CWB, and outdoor temperature of 35°CDB / 24°CWB.

Heating : Indoor temperature of 20°CDB / 15°CWB, and outdoor temperature of 7°CDB / 6°CWB.

Pipe length : 7.5 m; Height difference between outdoor unit and indoor unit : 0 m.

Dimensions (Unit : mm)

*Service accessibility must be allowed for when installing the product.

Please consult the installation manual for the necessary service access size.

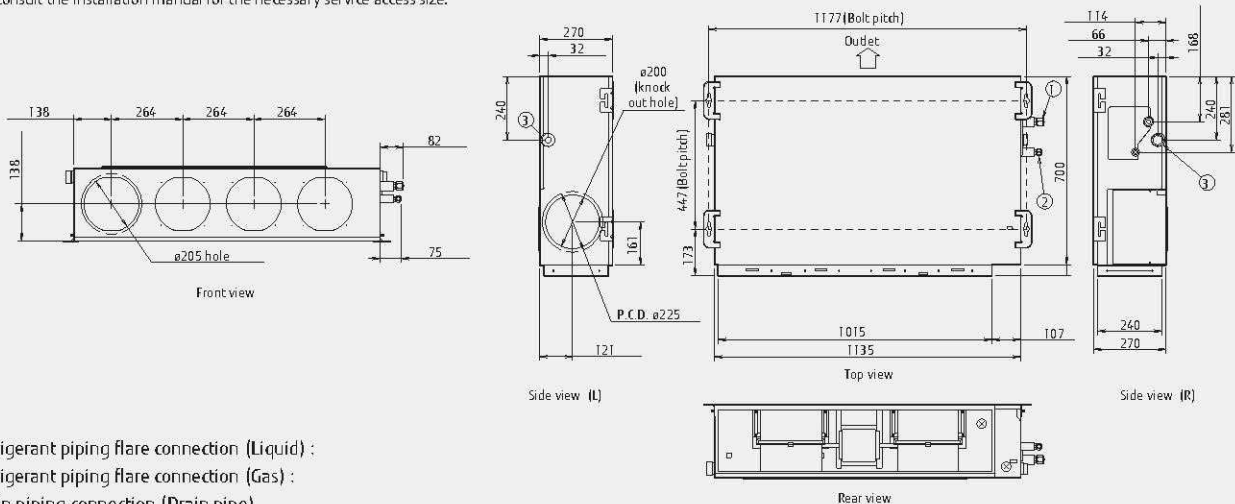

High Static Pressure Duct

Models

ARXC36GBTH



Models

ARXC72GBTH
ARXC90GBTH



Models

ARXC96GATH **NEW**



Feature

Static pressure selection

By using DC fan motor, it is possible to change static pressure range from 0 to 200Pa (ARXC36) / 300Pa (ARXC72/90/96). The change of static pressure range is possible by function setting with wired / wireless remote controller.

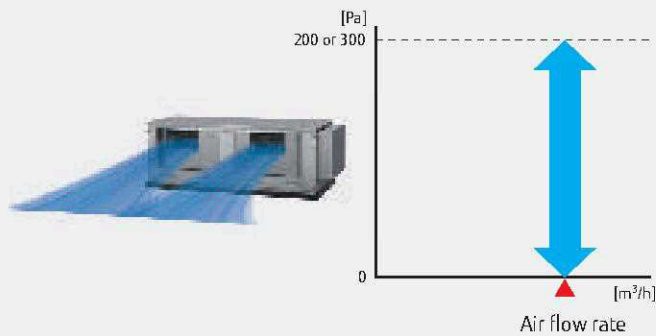

Low energy consumption by high efficiency DC fan motor

Improved motor efficiency from previous model.



(ARXC36 type)



(ARXC72 / 90 / 96 type)

Low noise

Models : ARXC36

Cutting off the corners of the conventional indoor unit front panel and fan casing, has enabled less turbulent air flow. Low noise is realized by adopting a plastic case and a plastic fan.

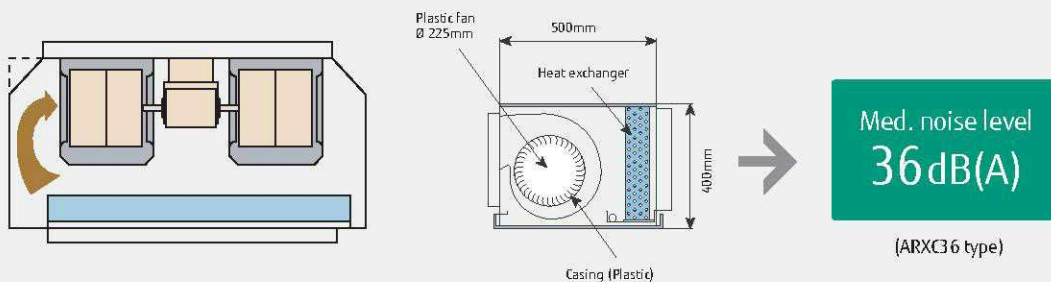

Feature

Easy installation (Compact size & Lightweight)

A compact size and lightweight indoor unit has been developed by reducing the basic chassis and the overall material weight.



Optional parts

Long-Life Filter : UTD-LF60KA (For ARXC36GBTH)
 IR Receiver Unit : UTB-YWC
 Remote Sensor Unit : UTY-XSZX

Specifications

Model name		ARXC36GBTH	ARXC72GBTH	ARXC90GBTH	ARXC96GATH
Power source		Single - phase, ~230V, 50Hz		Single - phase, ~230V, 50Hz	
Capacity	Cooling	11.2	22.4	25.0	28.0
	Heating	12.5	25.0	28.0	31.5
Input power		207	681	819	838
Airflow rate	High	1,990 (553)	3,900 (1,083)	4,300 (1,195)	4,850 (1,347)
	Med	1,680 (467)	3,300 (917)	4,000 (1,111)	4,250 (1,181)
	Low	1,330 (369)	3,000 (833)	3,500 (972)	3,600 (1,000)
Static pressure range		0 to 200	0 to 300	0 to 300	0 to 300
Standard static pressure		100	150	150	150
Sound pressure level	High	42	47	48	48
	Med	36	43	46	45
	Low	32	40	44	42
Dimensions (H x W x D)		400 x 1,050 x 500	450 x 1,587 x 700	450 x 1,587 x 700	550 x 1,587 x 700
Weight		40 (88)	84(185)	84(185)	105(231)
Connection pipe diameter	Liquid	9.52 (Flare)	12.70 (Brazing)	12.70 (Brazing)	12.70 (Brazing)
	Gas	19.05 (Flare)	22.22 (Brazing)	22.22 (Brazing)	22.22 (Brazing)
Drain hose diameter (I.D./O.U.)		25 / 32		25 / 32	

Note : Specifications are based on the following conditions.

Cooling : Indoor temperature of 27° CDB / 19° CWB, and outdoor temperature of 35° CDB / 24° CWB.

Heating : Indoor temperature of 20° CDB / (15° CWB), and outdoor temperature of 7° CDB / 6° CWB.

Pipe length : 7.5 m; Height difference between outdoor unit and indoor unit : 0 m.

Dimensions (Unit : mm)

Models: ARXC36

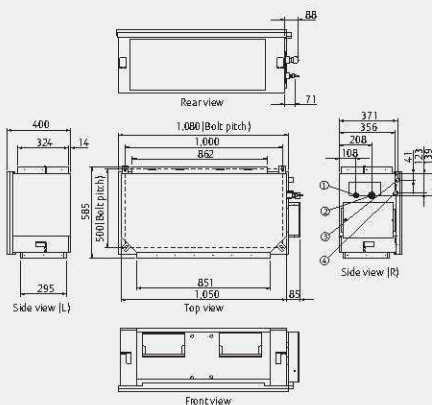

Models: ARXC72 / ARXC90

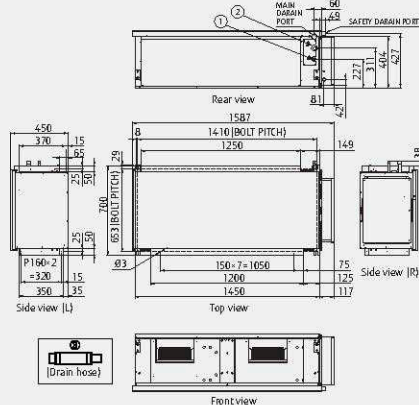

Models: ARXC96

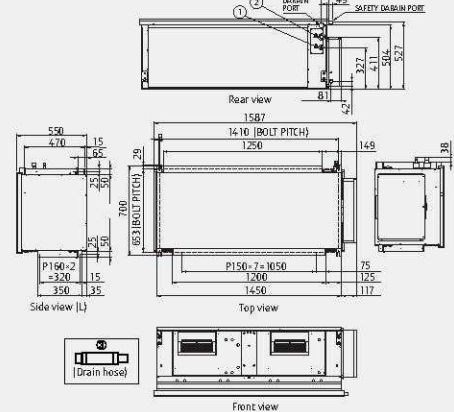

- ① Refrigerant piping flare connection (Liquid)
- ② Refrigerant piping flare connection (Gas)
- ③ Drain piping connection

- ① Refrigerant pipe flare connection (Liquid)
- ② Refrigerant pipe flare connection (Gas)
- ③ Drain hose

- ① Refrigerant pipe flare connection (Liquid)
- ② Refrigerant pipe flare connection (Gas)
- ③ Drain hose

High Static Pressure Duct

Models

ARXC45GATH
ARXC60GATH



Models

ARXC72GATH
ARXC90GATH



Feature

Static pressure selection

Models : ARXC72 / ARXC90

2 Types of static pressure mode are selectable.

Max.
300Pa



High Static Pressure Duct (ARXC72)

The adoption of a single phase fan motor allows 3 steps fan speed control

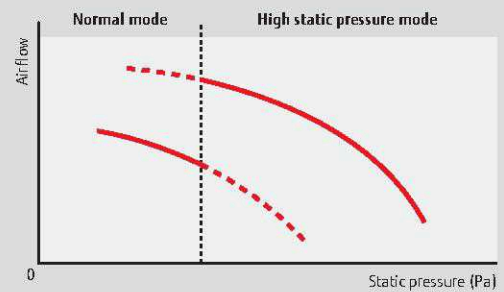

Low noise

Models : ARXC45 / ARXC60

Cutting off the corners of the conventional indoor unit front panel and fan casing, has enabled less turbulent air flow. Low noise is realized by adopting a plastic case and a plastic fan.

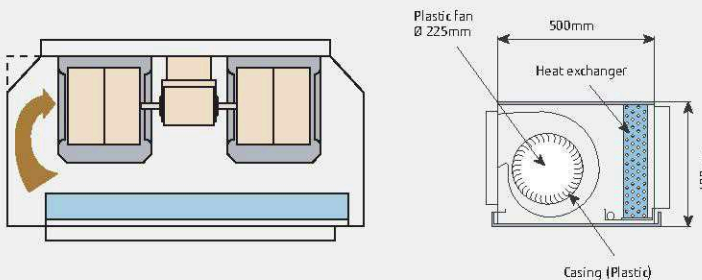

Med. noise level
45dB(A)

(ARXC45 / 60 type)

Feature

Easy installation (Compact size & Lightweight)

A compact size and lightweight indoor unit has been developed by reducing the basic chassis and the overall material weight.

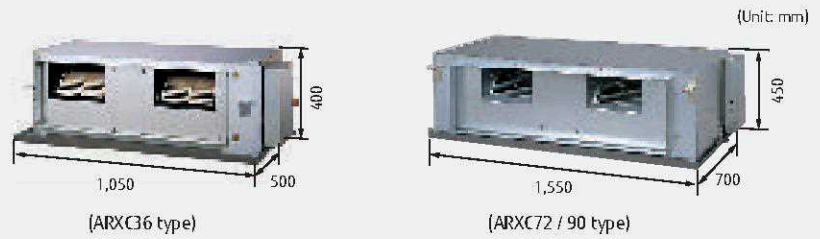

Optional parts

Long-Life Filter : UTD-LF60KA (For ARXC45/60GATH)
 IR Receiver Unit : UTB-YWC
 Remote Sensor Unit : UTY-XSZX

Specifications

Model name		ARXC45GATH	ARXC60GATH	ARXC72GATH	ARXC90GATH	
Power source		Single - phase, ~230V, 50Hz			Single - phase, ~230V, 50Hz	
Capacity	Cooling	kW	12.5	18.0	22.4	25.0
	Heating	kW	14.0	20.0	25.0	28.0
Input power		W	715	730	1,110	1,250
Airflow rate	High	m ³ /h (l/s)	3,500 (972)	3,500 (972)	3,900 (1,083)	4,300 (1,195)
	Med	m ³ /h (l/s)	3,000 (833)	3,000 (833)	3,300 (917)	4,000 (1,111)
	Low	m ³ /h (l/s)	2,460 (683)	2,460 (683)	3,000 (833)	3,500 (972)
Static pressure range		Pa	100 to 250	100 to 250	50 to 300	100 to 300
Standard static pressure		Pa	100	100	260	250
Sound pressure level	High	dB(A)	49	49	51	53
	Med	dB(A)	45	45	48	51
	Low	dB(A)	42	42	45	49
Dimensions (H x W x D)		mm	400 x 1,050 x 500	400 x 1,050 x 500	450 x 1,550 x 700	450 x 1,550 x 700
Weight		kg(lbs)	46 (101)	46 (101)	83 (-)	85(-)
Connection pipe diameter	Liquid	mm	9.52 (Flare)	9.52 (Flare)	12.70 (Brazing)	12.70 (Brazing)
	Gas	mm	19.05 (Flare)	19.05 (Flare)	22.22 (Brazing)	22.22 (Brazing)
Drain hose diameter (I.D./O.U.)			25 / 32		25 / 32	

Note : Specifications are based on the following conditions.

Cooling : Indoor temperature of 27°C DB / 19°C CWB, and outdoor temperature of 35°C DB / 24°C CWB.
 Heating : Indoor temperature of 20°C DB / (15°C CWB), and outdoor temperature of 7°C DB / 6°C CWB.
 Pipe length : 7.5 m; Height difference between outdoor unit and indoor unit : 0 m.

Dimensions (Unit: mm)

Models: ARXC45 / ARXC60

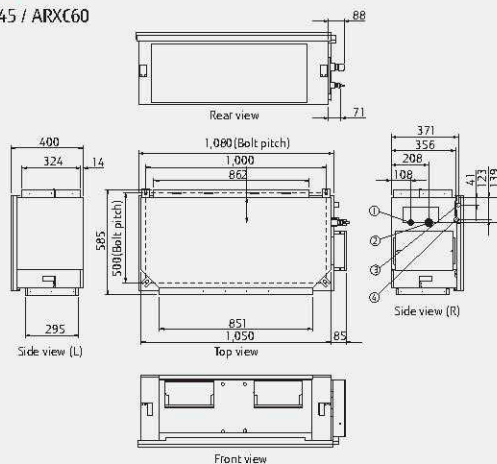

Models: ARXC72 / ARXC90

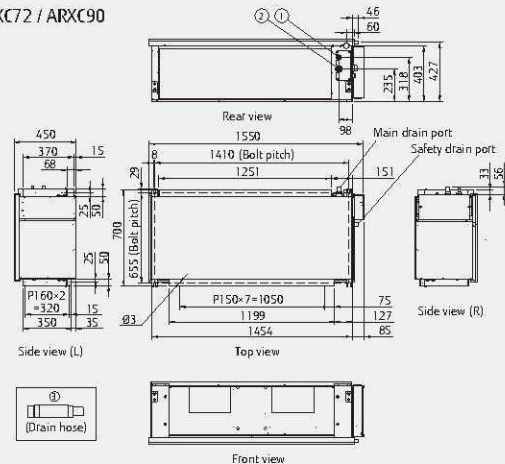

- ① Refrigerant piping flare connection (Liquid)
- ② Refrigerant piping flare connection (Gas)
- ③ Drain piping connection

- ① Refrigerant pipe flare connection (Liquid)
- ② Refrigerant pipe flare connection (Gas)
- ③ Drain hose

Large Airflow Duct

Models

- ARXN18GATH
- ARXN24GATH
- ARXN30GATH
- ARXN34GATH
- ARXN36GATH
- ARXN45GATH



Feature

Large airflow volume

It can be installed in places such as early replacement of air required by large airflow volume.

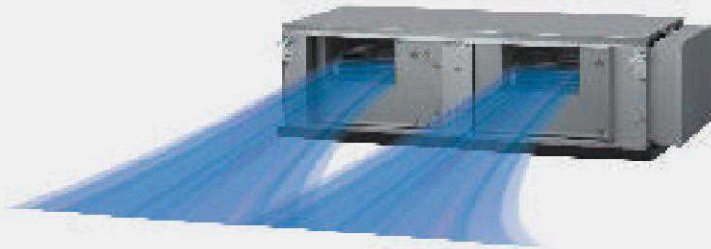

Installation styles

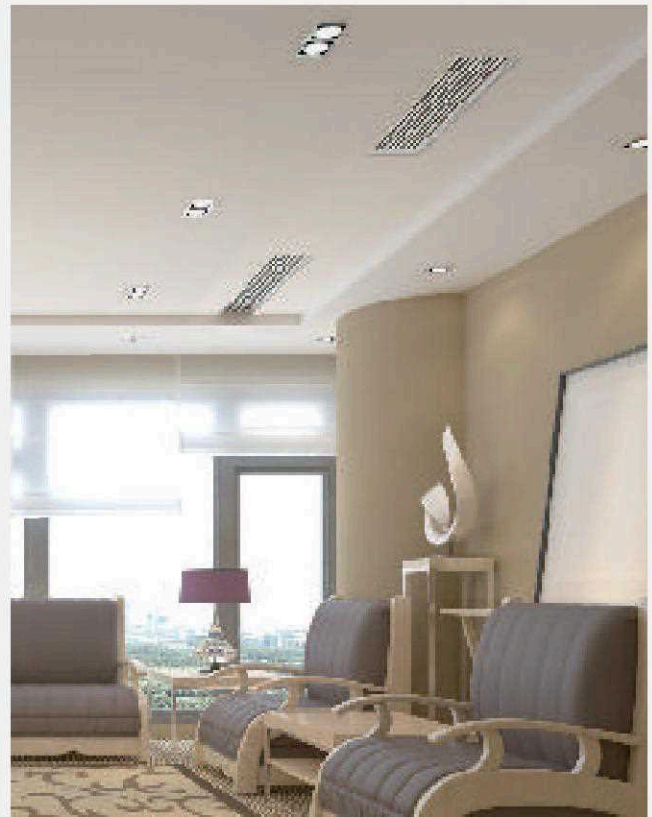
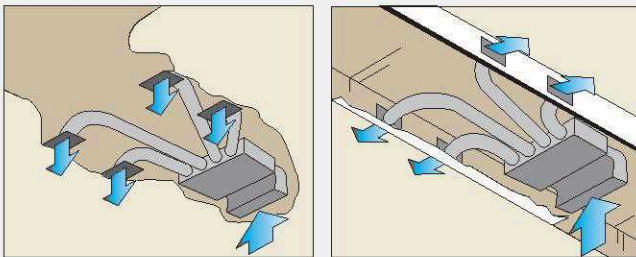

Feature

Selectable with a wide range of static pressure



static pressure range
50 to 250Pa

(30 / 34class)

static pressure range
50 to 300Pa

(36 / 45class)

Optional parts

Remote Sensor Unit : UTY-XSZX

Specifications

Model name			ARXN18GATH	ARXN24GATH	ARXN30GATH	ARXN34GATH	ARXN36GATH	ARXN45GATH
Power source			Single - phase, ~230V, 50Hz					
Capacity	Cooling	kW	5.6	7.1	9.0	10.0	11.2	12.5
	Heating	kW	6.3	8.0	10.0	11.2	12.5	14.0
Input power		W	154	205	306	432	572	572
Airflow rate	High	m ³ /h (l/s)	2,280 (633)	2,640 (733)	3,200 (889)	3,720 (1,033)	4,120 (1,145)	4,120 (1,145)
	Med	m ³ /h (l/s)	—	—	—	—	—	—
	Low	m ³ /h (l/s)	—	—	—	—	—	—
Static pressure range		Pa	50 to 100	50 to 150	50 to 250	50 to 250	50 to 300	50 to 300
Standard static pressure		Pa	50	50	50	50	60	60
Sound pressure level	High	dB(A)	35	37	40	43	45	45
	Med	dB(A)	—	—	—	—	—	—
	Low	dB(A)	—	—	—	—	—	—
Dimensions (H x W x D)		mm	450 x 1,587 x 700	450 x 1,587 x 700	450 x 1,587 x 700	450 x 1,587 x 700	450 x 1,587 x 700	450 x 1,587 x 700
Weight		kg(lbs)	84 (185)	84 (185)	84 (185)	84 (185)	84 (185)	84 (185)
Connection pipe diameter	Liquid (Flare)	mm	9.52	9.52	9.52	9.52	9.52	9.52
	Gas (Flare)	mm	15.88	15.88	15.88	15.88	19.05	19.05
Drain hose diameter (I.D./O.U.)			25 / 32					

Note : Specifications are based on the following conditions.
Large Airflow Duct can be connected to V-III series only.

Cooling : Indoor temperature of 27°CDB / 19°CWB, and outdoor temperature of 35°CDB / 24°CWB.
Heating : Indoor temperature of 20°CDB / (15°CWB), and outdoor temperature of 7°CDB / 6°CWB.
Pipe length : 7.5 m; Height difference between outdoor unit and indoor unit : 0 m. Voltage : 230 [V].

Dimensions (Unit : mm)

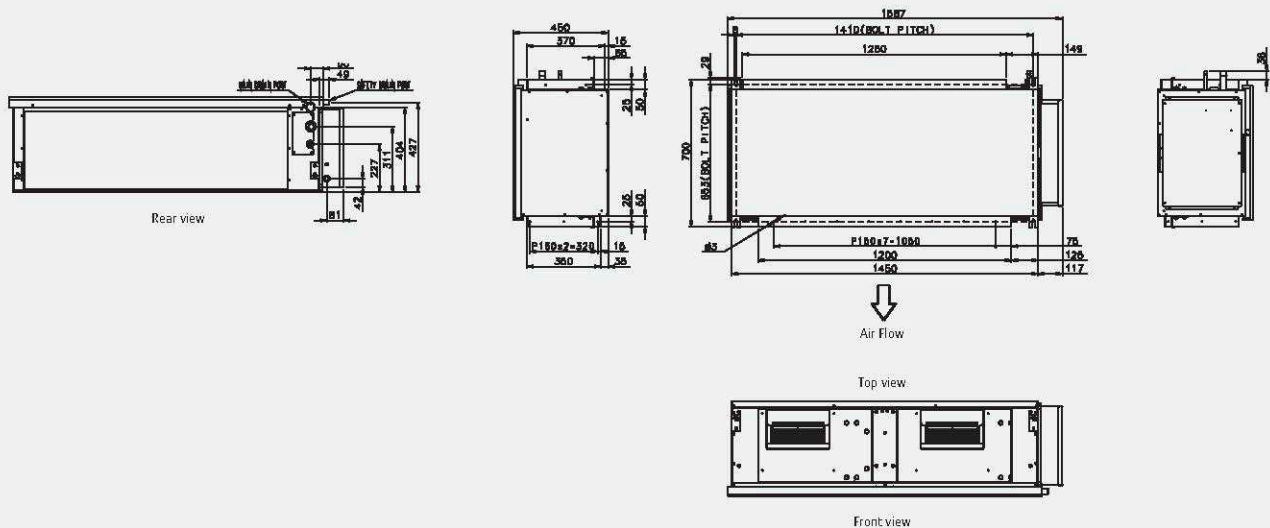

Floor / Ceiling

Models

- ABHA12GATH
- ABHA14GATH
- ABHA18GATH
- ABHA24GATH

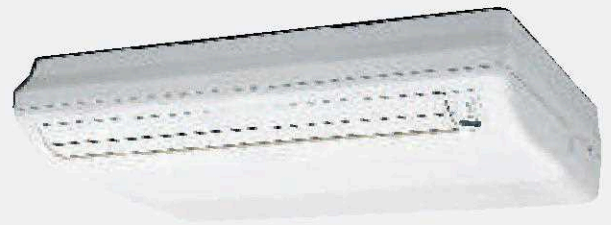

Floor standing



Feature

Flexible installation

Example for floor installation

Floor console



Example for ceiling installation

Under ceiling

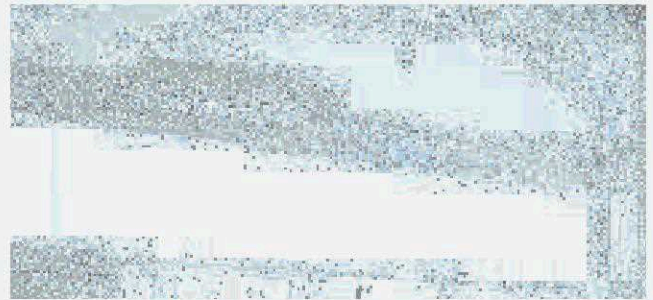

Double auto swing

A combination of up/down and right/left directional swing allows three-dimensional air direction control.

RIGHT and LEFT SWING

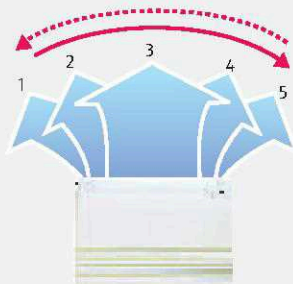

UP and DOWN SWING

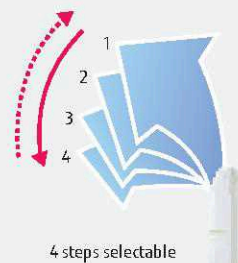

High power DC fan motor

- High power
- Wide rotation range
- High efficiency

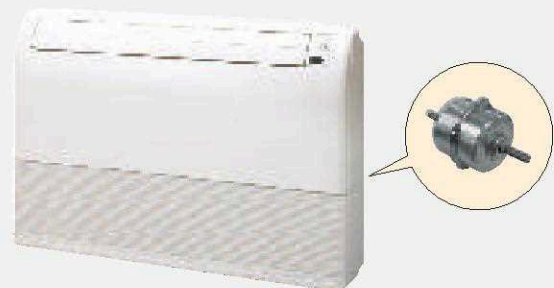

Feature

Compact design

Symmetrical, slim and compact design.

(Unit : mm)

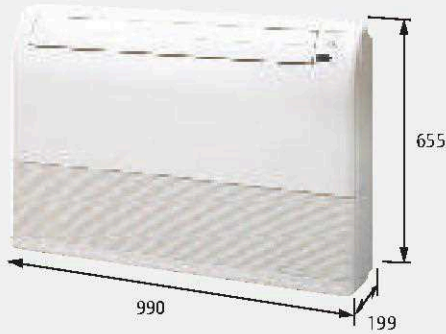

Auto-closing louvre

When operation is stopped, the louvres will automatically close. (This function is available on all non-ducted models.)

Super vane

Double Louvre Super vane with newly developed special configuration boosts airflow sending cool air quickly to every corner of the room.

Specifications

Model name			ABHA12GATH	ABHA14GATH	ABHA18GATH	ABHA24GATH
Power source			Single - phase, ~230V, 50Hz			
Capacity	Cooling	kW	3.6	4.5	5.6	7.1
	Heating		4.0	5.0	6.3	8.0
Input power		W	30	42	74	99
Airflow rate	High	m ³ /h (l/s)	660 (183)	780 (216)	1,000 (277)	1,000 (277)
	Med		570 (158)	640 (177)	720 (199)	820 (227)
	Low		490 (136)	550 (152)	580 (161)	680 (188)
Sound pressure level	High	dB(A)	36	40	46	47
	Med		32	36	39	42
	Low		28	34	35	37
Dimensions (H x W x D)		mm	199 x 990 x 655	199 x 990 x 655	199 x 990 x 655	199 x 990 x 655
Weight		kg(lbs)	25 (55)	26 (57)	26 (57)	27 (59)
Connection pipe diameter	Liquid (Flare)	mm	6.35	6.35	9.52	9.52
	Gas (Flare)		12.70	12.70	15.88	15.88
Drain hose diameter (I.D./O.U.)			25 / 32			

Note : Specifications are based on the following conditions.

Cooling : Indoor temperature of 27°CDB / 19°CWB, and outdoor temperature of 35°CDB / 24°CWB.

Heating : Indoor temperature of 20°CDB / (15°CWB), and outdoor temperature of 7°CDB / 6°CWB.

Pipe length : 7.5 m; Height difference between outdoor unit and indoor unit : 0 m. Voltage : 230 [V].

Dimensions (Unit : mm)

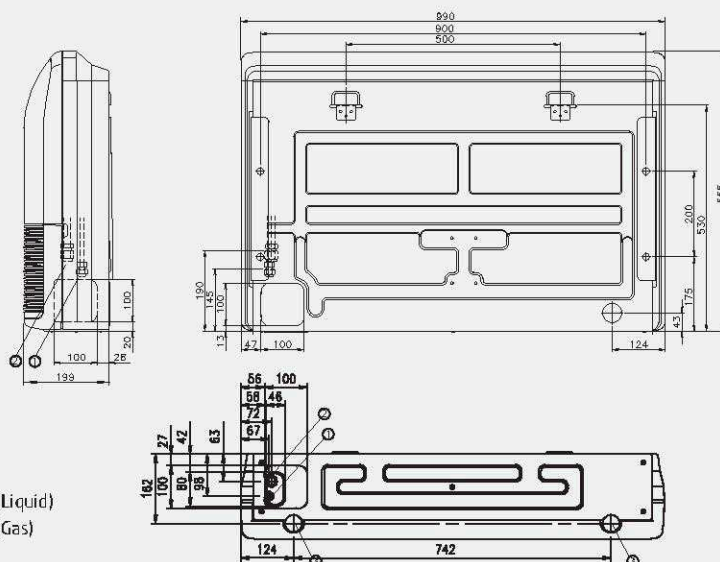

Ceiling

Models

- ABHA30GATH
- ABHA36GATH
- ABHA45GATH
- ABHA54GATH



Feature

Installation

Open

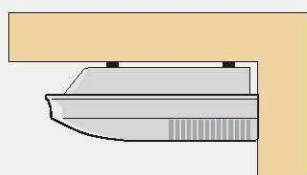

General installation pattern which suspends the indoor unit from the ceiling.

Concealed

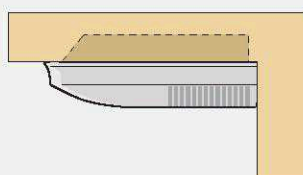

Installation pattern where part of the indoor unit is embedded into the ceiling.

Wall mounted

(Field Supplied)

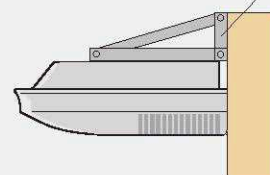

Installation which fixes the indoor unit to the wall by the use of wall brackets (Field supplied). This type of installation can be used when the ceiling space is insufficient.

Double auto swing and wide airflow

Auto airflow direction and auto swing

Right and left

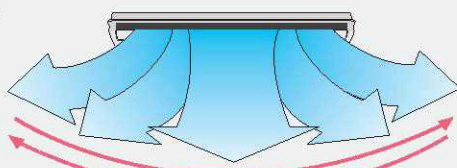

5 steps selectable

Up and down

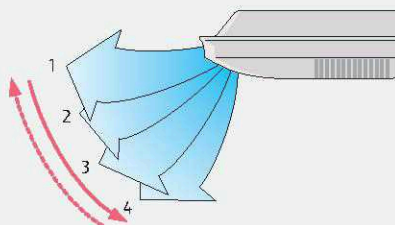

4 steps selectable

Long airflow

Long Airflow ensures comfort to every corner of a large room.

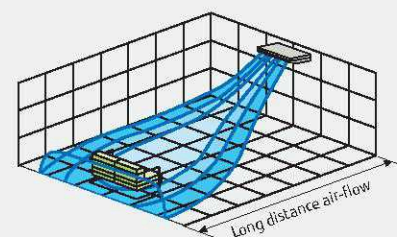

High power DC fan motor

- High power
- Wide rotation range
- High efficiency



Feature

Fresh air intake

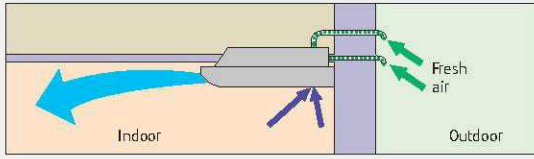

High lift drain pump

Optional drain pump unit allows flexible installation design.

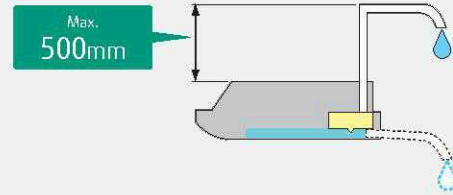

Slim & Compact design

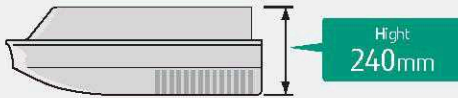

Optional parts

Drain Pump Unit : UTR-DPB24T
Flange : UTD-RF204

Specifications

Model name			ABHA30GATH	ABHA36GATH	ABHA45GATH	ABHA54GATH
Power source			Single - phase, ~230V, 50Hz			
Capacity	Cooling	kW	9.0	11.2	12.5	14.0
	Heating		10.0	12.5	14.0	16.0
Input power		W	66	85	131	180
Airflow rate	High	m ³ /h (l/s)	1,630 (452)	1,690 (469)	2,010 (558)	2,270 (629)
	Med		1,370 (379)	1,400 (389)	1,600 (444)	1,780 (493)
	Low		1,140 (316)	1,170 (325)	1,230 (342)	1,280 (355)
Sound pressure level	High	dB(A)	42	45	48	51
	Med		38	38	42	45
	Low		33	34	35	36
Dimensions (H x W x D)		mm	240 × 1,660 × 700	240 × 1,660 × 700	240 × 1,660 × 700	240 × 1,660 × 700
Weight		kg(lbs)	46 (101)	48 (106)	48 (106)	48 (106)
Connection pipe diameter	Liquid (Flare)	mm	9.52	9.52	9.52	9.52
	Gas (Flare)		15.88	19.05	19.05	19.05
Drain hose diameter (I.D./O.U.)			25 / 32			

Note : Specifications are based on the following conditions.

Cooling : Indoor temperature of 27°CDB / 19°CWB, and outdoor temperature of 35°CDB / 24°CWB.

Heating : Indoor temperature of 20°CDB / (15°CWB), and outdoor temperature of 7°CDB / 6°CWB.

Pipe length : 7.5 m; Height difference between outdoor unit and indoor unit : 0 m. Voltage : 230 [V].

Dimensions (Unit : mm)

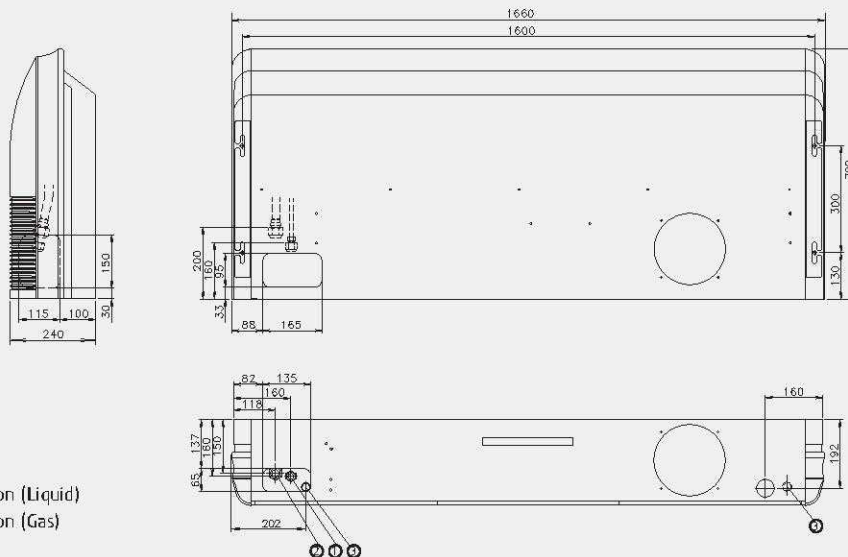

- ① Refrigerant piping flare connection (Liquid)
- ② Refrigerant piping flare connection (Gas)
- ③ Drain piping connection

Wall Mounted

Models (EEV internal)	Models (EEV internal)	Models (EEV external)
ASHA07GACH	ASHA07GATH	ASHE07GACH
ASHA09GACH	ASHA09GATH	ASHE09GACH
ASHA12GACH	ASHA12GATH	ASHE12GACH
ASHA14GACH	ASHA14GATH	ASHE14GACH



Feature

Filter features

High quality air conditioning by incorporation of high performance filter.



Ion Deodorization Filter

The filter deodorizes by powerfully decomposing absorbed odors using the oxidizing and reducing effects of ions generated by the ultra-fine-particle ceramic.



Apple-catechin Filter

Apple-catechin filter uses static electricity to clean fine particles and dust in the air.

Deodorizing effect (Odor reduction rate)

Ammonia



Trimethylamine

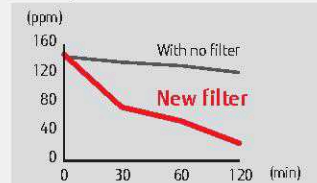

Hydrogen sulfate



Testing organization :
Environmental Sanitary Inspection Center
Test method :
Deodorization Test

Auto swing louvre

The Auto Swing Louvre function ensures that the air direction corresponds to the mode selected.

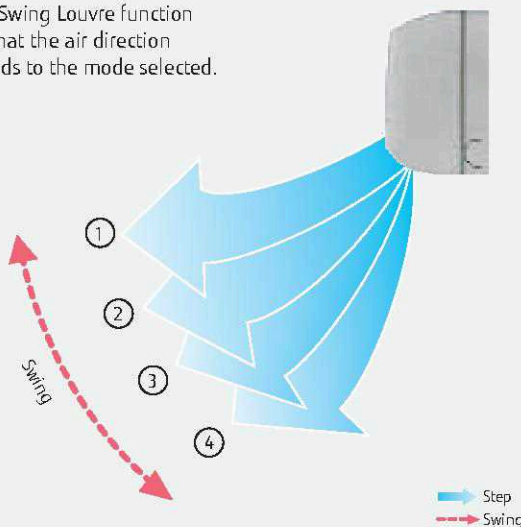

Compact size

Powerful output even compact design

Though the indoor unit is compact, it features a large, high pressure cross fan (90mm diameter) in a centre mounted configuration and a Lambda type heat exchanger to provide plenty of power.

Width
790mm



790mm

Feature

New style high power DC fan motor

- High power
- Wide rotation range
- High efficiency
- Compact size



Easy maintenance

Easy maintenance has been realized as the front panel can be removed for easy access.

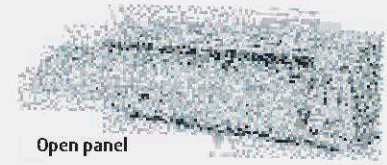

Symmetrical design

Symmetrical, clean design that suits all interiors.

Specifications

Model name		ASHA07GACH ASHA07GATH	ASHA09GACH ASHA09GATH	ASHA12GACH ASHA12GATH	ASHA14GACH ASHA14GATH	ASHE07GACH	ASHE09GACH	ASHE12GACH	ASHE14GACH
Power source		Single - phase, ~230V, 50Hz				230V ~, 50Hz			
Capacity	Cooling	2.2	2.8	3.6	4.5	2.2	2.8	3.6	4.5
	Heating	2.8	3.2	4.1	5.0	2.8	3.2	4.1	5.0
Input power		17	18	22	34	15	16	21	34
Airflow rate	High	490 (136)	500 (139)	560 (156)	670 (186)	490 (136)	500 (139)	560 (156)	680 (189)
	Med	450 (125)	450 (125)	480 (133)	490 (136)	450 (125)	450 (125)	480 (133)	490 (136)
	Low	370/420*1 (103/117*1)	370/420*1 (103/117*1)	420 (117)	420 (117)	370/420*1 (103/117*1)	370/420*1 (103/117*1)	420 (117)	420 (117)
Sound pressure level	High	35	36	39	44	34	35	38	43
	Med	33	33	35	37	32	32	34	35
	Low	27 / 31*1	27 / 31*1	31	32	26 / 30*1	26 / 30*1	30	30
Dimensions (H x W x D)		275 x 790 x 215	275 x 790 x 215	275 x 790 x 215	275 x 790 x 215	275 x 790 x 215	275 x 790 x 215	275 x 790 x 215	275 x 790 x 215
Weight		9 (20)	9 (20)	9 (20)	9 (20)	9 (20)	9 (20)	9 (20)	9 (20)
Connection pipe diameter	Liquid (Flare)	6.35	6.35	6.35	6.35	6.35	6.35	6.35	6.35
	Gas (Flare)	12.70	12.70	12.70	12.70	12.70	12.70	12.70	12.70
Drain hose diameter (I.D./O.U.)		13.8 / 15.8 to 16.7				13.8 / 15.8 to 16.7			
EV Kit (option)		—	—	—	—	UTR-EV09XB	UTR-EV09XB	UTR-EV14XB	UTR-EV14XB

Note : Specifications are based on the following conditions.

*1 : This value is under cooling operation.

Cooling : Indoor temperature of 27°CDB / 19°CWB, and outdoor temperature of 35°CDB / 24°CWB.

Heating : Indoor temperature of 20°CDB / (15°CWB), and outdoor temperature of 7°CDB / 6°CWB.

Pipe length : 7.5 m; Height difference between outdoor unit and indoor unit : 0 m. Voltage : 230 [V].

Dimensions (Unit : mm)

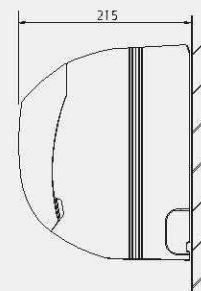
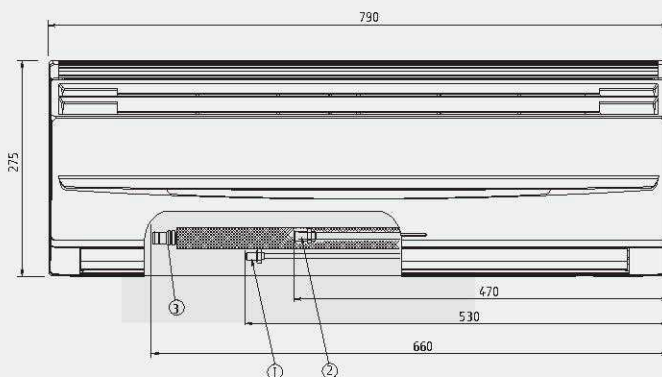

- ① Refrigerant pipe flare connection (Liquid)
- ② Refrigerant pipe flare connection (Gas)
- ③ Drain piping connection

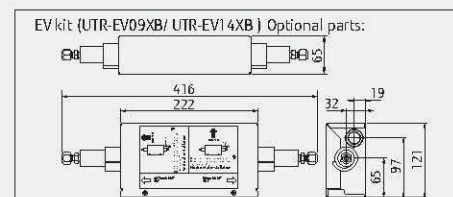

Wall Mounted

Models

ASHA18GACH
ASHA24GACH
ASHA30GACH

Models

ASHA18GATH
ASHA24GATH
ASHA30GATH



Feature

More comfort airflow by adopting power diffuser

“Vertical airflow” provides powerful floor level heating

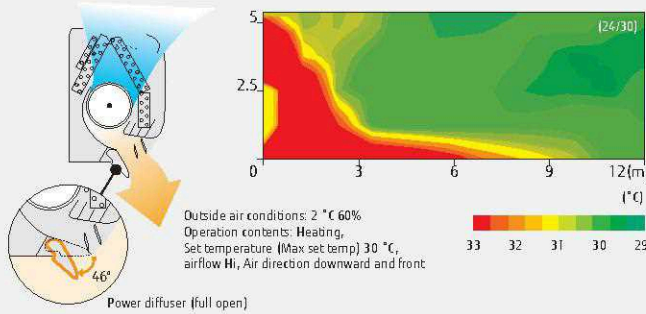

“Horizontal airflow” does not blow cool air directly at the occupants in the room

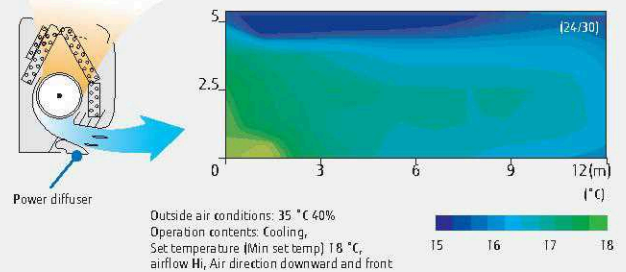

Air conditioner filter features

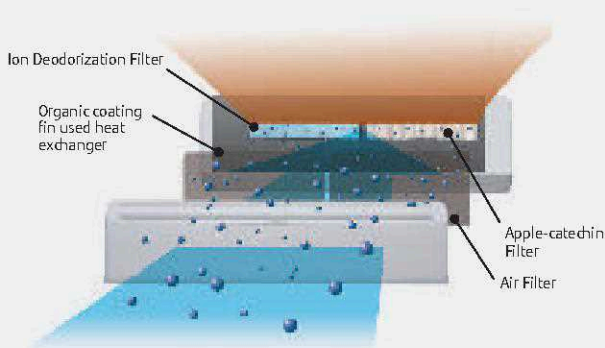

High quality air conditioning by incorporation of high performance filter.



The filter deodorizes by powerfully decomposing absorbed odors using the oxidizing and reducing effects of ions generated by the ultra-fine-particle ceramic.



Apple-catechin filter uses static electricity to clean fine particles and dust in the air.

Double auto swing

A combination of up/down and right/left directional swing allows three-dimensional air direction control.

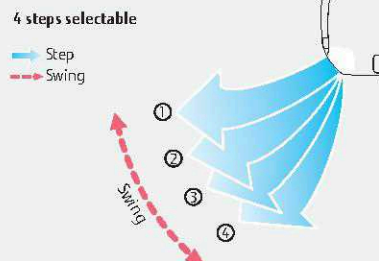
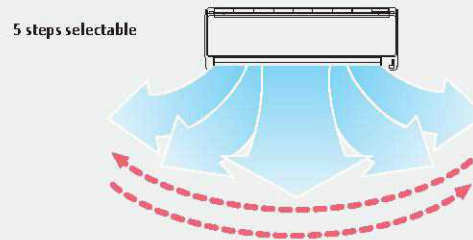

Feature

Compact & Slim design

By using DC fan motor, compact design is realized.



Easy maintenance

Simplification of drain pan cleaning improves maintenance-ability.

Specifications

Model name			ASHA18GACH ASHA18GATH	ASHA24GACH ASHA24GATH	ASHA30GACH ASHA30GATH
Power source			Single - phase, ~230V, 50Hz		
Capacity	Cooling	kW	5.6	7.1	8.0
	Heating		6.3	8.0	9.0
Input power		W	32	60	91
Airflow rate	High	m ³ /h (l/s)	840 (233)	1,100 (305)	1,240 (343)
	Med		770 (213)	910 (252)	980 (271)
	Low		690 (191)	730 (202)	770 (213)
Sound pressure level	High		41	48	52
	Med	dB(A)	39	43	45
	Low		35	35	35
Dimensions (H x W x D)		mm	320 x 998 x 228	320 x 998 x 228	320 x 998 x 228
Weight		kg(lbs)	15 (33)	15 (33)	15 (33)
Connection pipe diameter	Liquid (Flare)		9.52	9.52	9.52
	Gas (Flare)	mm	15.88	15.88	15.88
Drain hose diameter (I.D./O.U.)			12 / 16		

Note : Specifications are based on the following conditions.

Cooling : Indoor temperature of 27°CDB / 19°CWB, and outdoor temperature of 35°CDB / 24°CWB.

Heating : Indoor temperature of 20°CDB / (15°CWB), and outdoor temperature of 7°CDB / 6°CWB.

Pipe length : 7.5 m; Height difference between outdoor unit and indoor unit : 0 m. Voltage : 230 [V].

Dimensions (Unit : mm)

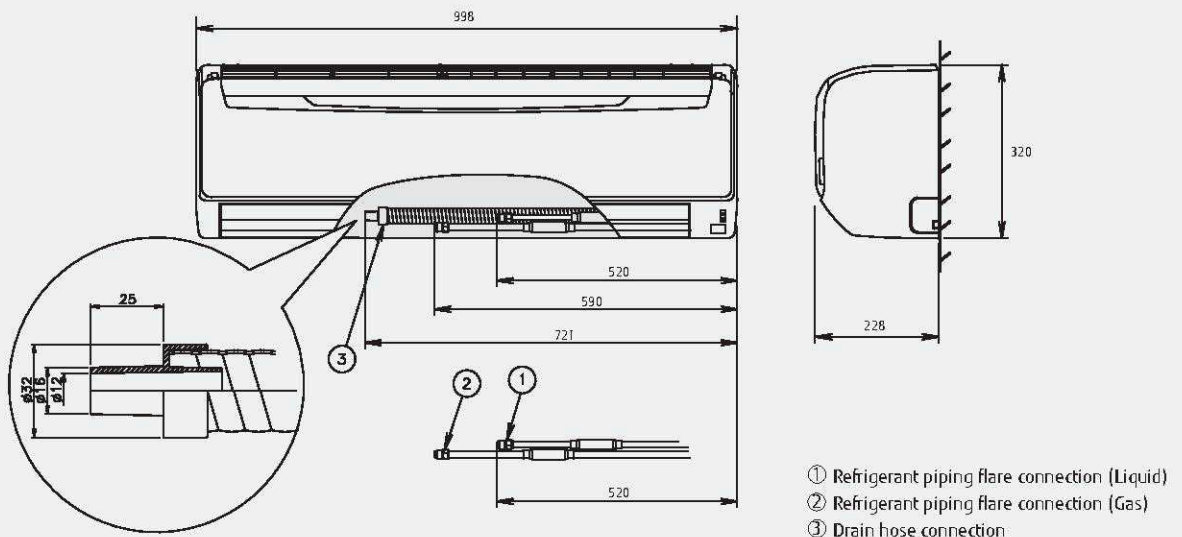

Control System Overview

Every user's needs are supported by offering a variety of controls, such as individual control, central control and building management control options.

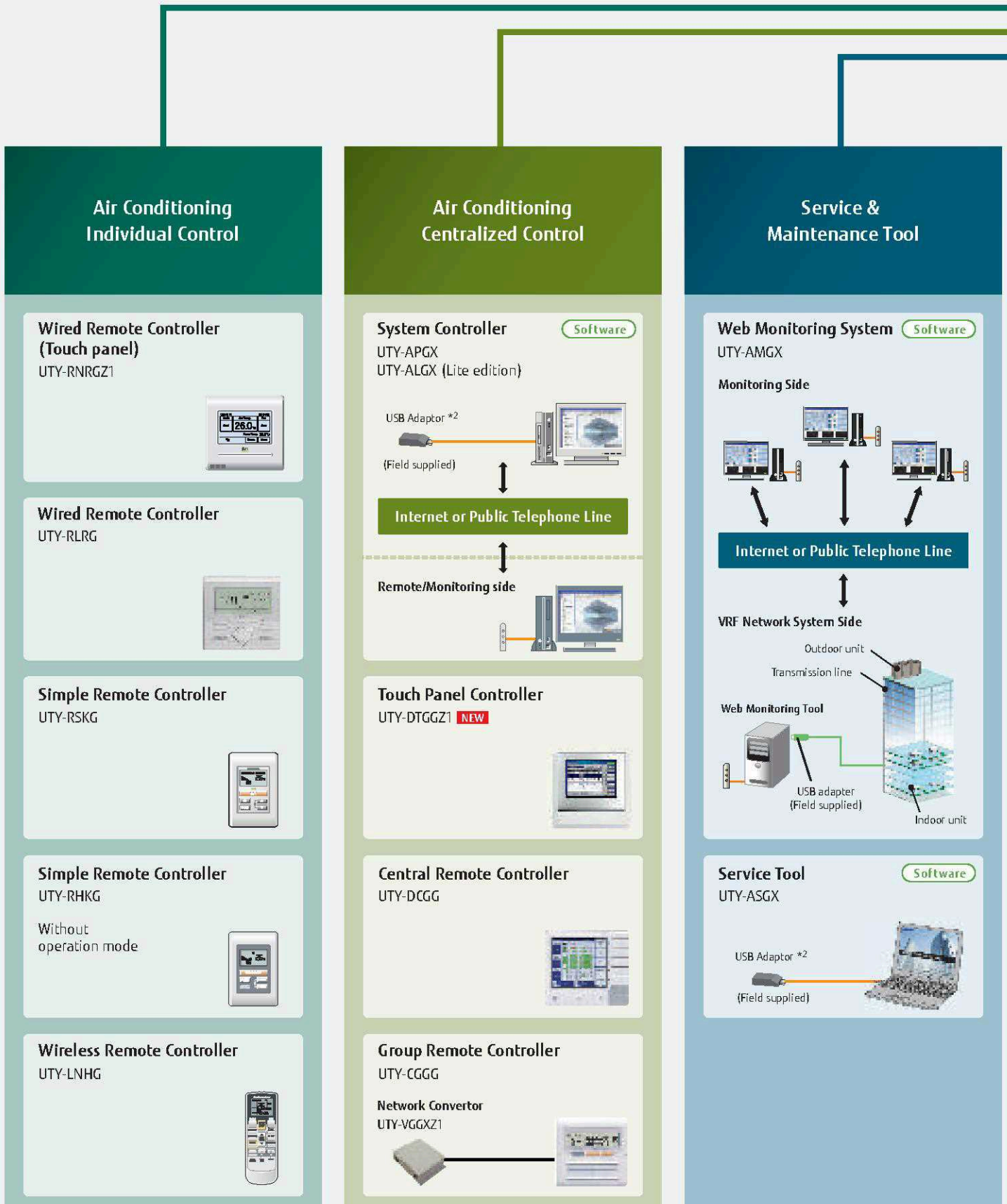



Converter / Adaptor (for system expansion)

Network Converter

DC power supply type
UTY-VTGX **NEW**



AC power supply type
UTY-VTGXV **NEW**



Network Converter

UTY-VGGXZ1

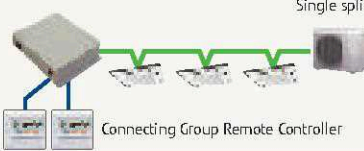

Signal Amplifier

UTY-VSGXZ1

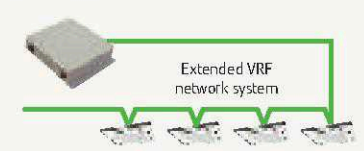

Converter / Adaptor (for external device)

BACnet® Gateway

UTY-ABGX

Software

USB Adaptor *2

(Field supplied)



Network Converter (BMS/LONWORKS®)

UTY-VLGX



MODBUS® Converter

UTY-VMGX **NEW**



External Switch Controller

UTY-TEKX



BMS/BAS*1

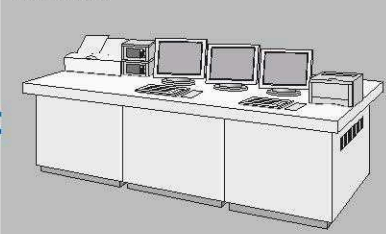

BMS, Home automation system



Card-key

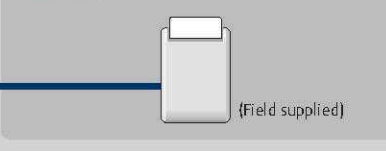

*1. BMS/BAS: Building Management System/Building Automation System *2. USB Adaptor: Echelon® U10 USB Network Interface







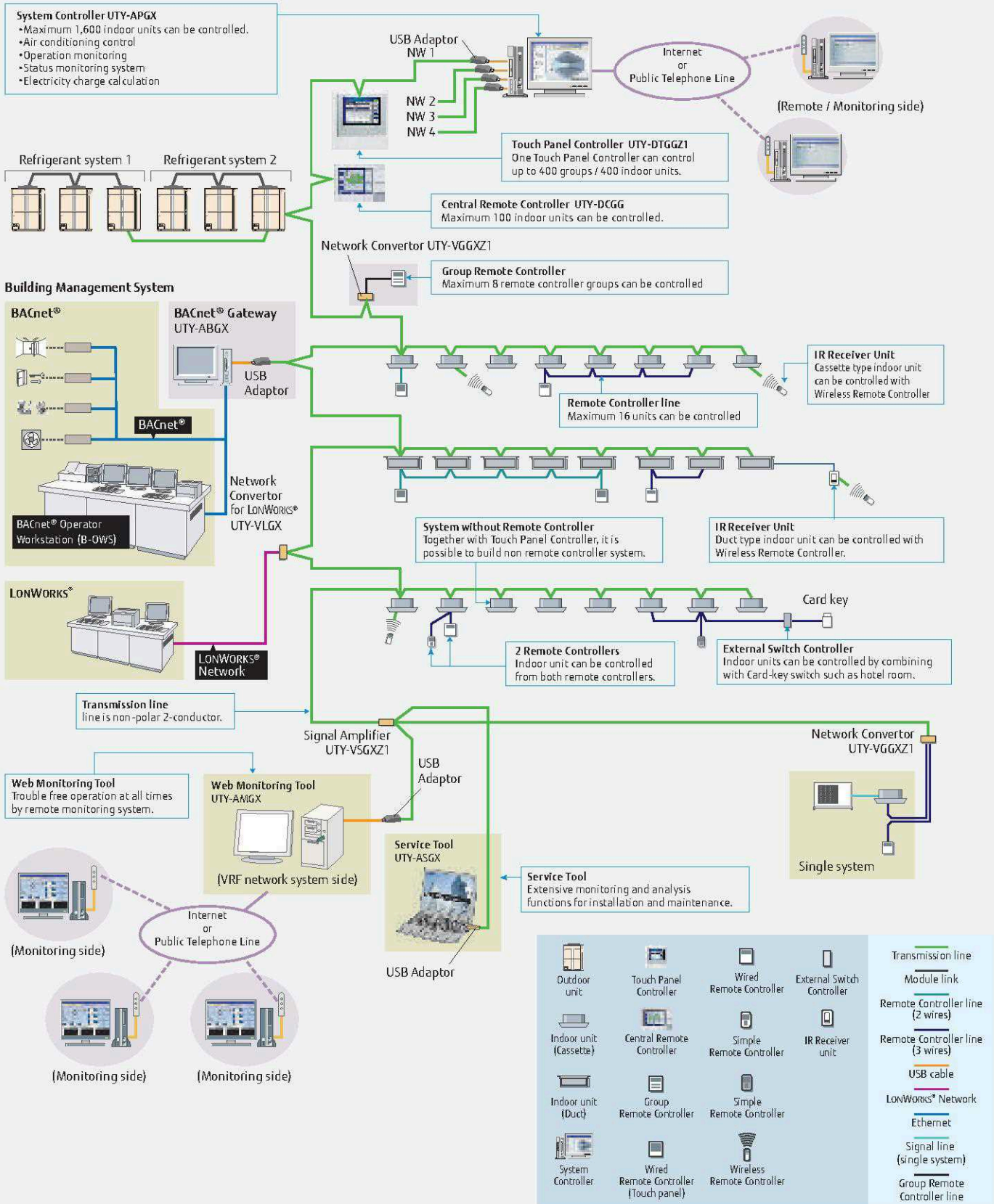



Wiring system

Max. transmission line length
3,600m

- Wiring construction of the control system is made of power source wiring, transmission wiring and remote controller wiring.
- Total wiring length (total length of transmission line) can be extended up to 3,600m (by using signal amplifiers).



Comparison table of Controllers

Item												
Model name	UTY-RNRGZ1	UTY-RLRG	UTY-RSKG	UTY-RHKG	UTY-LNHG	UTY-CGGG	UTY-DCGG	UTY-DTGGZ1	UTY-ALGX	UTY-APGX		
Max. controllable remote controller groups	1	1	1	1	1	8	100	400	400	1600		
Max. controllable indoor units	16	16	16	16	16	128	100	400	400	1600		
Max. controllable groups	—	—	—	—	—	—	16	400	400	1600		
Air conditioning control function	On / Off	●	●	●	●	●	●	●	●	●		
	Operation mode setting	●	●	●	—	●	●	●	●	●		
	Fan speed setting	●	●	●	●	●	●	●	●	●		
	Room temp. setting	●	●	●	●	●	●	●	●	●		
	Room temp. set point limitation	●	●	—	—	—	—	●	●	●		
	Test operation	●	●	●	—	●	—	●	●	—		
	Up/down air direction flap setting	●	●	—	—	●	—	●	●	●		
	Right/left air direction flap setting	●	●	—	—	●	—	●	●	●		
	Group setting	—	—	—	—	—	—	●	●	●		
	RC prohibition	—	—	—	—	—	—	●	●	●		
	Anti freeze setting	●	—	—	—	—	—	●	●	●		
	Economy mode setting	●	●	—	—	●	—	●	●	●		
Display	Error	●	●	●	●	—	●	●	●	●		
	Defrosting	●	●	●	●	—	—	●	●	●		
	Current time	●	●	—	—	●	●	●	●	●		
	Day of week	●	●	—	—	—	●	—	●	●		
	R.C. prohibition	●	●	●	●	—	●	●	●	●		
	Cooling/heating priority	●	●	●	●	—	●	●	●	●		
	Address display	●	●	●	●	—	●	●	●	●		
	Room temp	●	—	—	—	—	—	—	—	—		
	Multi language	●	—	—	—	—	—	●	●	●		
	Summer time	●	—	—	—	—	—	●	●	●		
	Name registration	●	—	—	—	—	—	●	●	●		
	Backlight	●	—	●	●	—	—	●	●	—		
	2D floor layout / 3D building display	—	—	—	—	—	—	—	—	—	●	
	Timer	Schedule timer	Period	Week	Week	—	—	—	Week	Week	Year	Year
On/off, Temp, Mode, Times per day			8	4	—	—	—	4	20	20	144	144
On/off timer		●	●	—	—	●	—	—	—	—	—	
Sleep timer		—	—	—	—	●	—	—	—	—	—	
Program timer		—	—	—	—	●	—	—	—	—	—	
Auto off timer		●	●	—	—	—	—	—	—	—	—	
Day off		●	●	—	—	—	—	●	●	●	●	
Min. unit of timer setting (Minutes)	10 • 30	30	30	30	5	10	10	10	10	10		
Control	Status monitoring system	—	—	—	—	—	—	●	●	●	●	
	Electricity charge apportionment	—	—	—	—	—	—	○	○	●	●	
	Error history	●	●	●	●	—	●	●	●	●	●	
	Emergency stop	—	—	—	—	—	—	●*2	●*2	—	—	
	Remote management	—	—	—	—	—	—	●	○	○	●	
	Energy saving management	—	—	—	—	—	—	—	○	○	○	
	E-mail notification for malfunction	—	—	—	—	—	—	●	●	●	●	
	Key lock	●	●	—	—	—	●	●	●	●	●	
	Child lock	Child lock	—	—	—	Child lock	Password setting	Password setting	Password setting	Password setting		

*1 "Operation mode" setting is not available for this model.

*2 This function is available only through external input control.

● : Supported ○ : Optional function — : Not supported yet

Wired Remote Controller (Touch Panel)

Max. controllable
16
indoor units

UTY-RNRGZ1

Easy operation by high-definition large STN-LCD touch panel screen

- Easy finger touch operation with LCD panel
- Built-in weekly/Daily timer (ON/OFF,Temp.,Mode)
- Backlight enables easy operation in a darkened room
- Room temperature display
- Control up to 16 indoor units
- Corresponds to 12 different languages (English, Chinese, French, German, Spanish, Russian, Polish, Italian, Greek, Portuguese, Turkish and Dutch)



Functions

High performance and compact size

- In addition to the individual control, various energy saving controls can be realized using one remote controller only.



Accurate and comfortable control

- Indoor temperature can be detected accurately by the inclusion of a thermo sensor in the body of the wired controller.

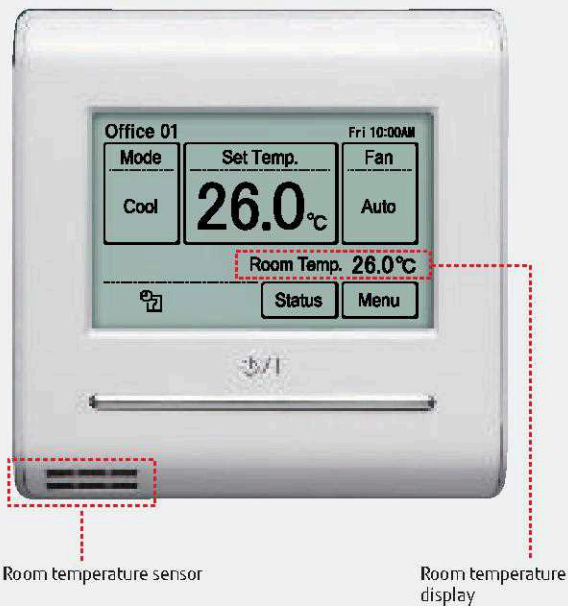

Backlight

- Backlight enable easy operation in a darkened room.
- For the lighting time of Backlight, 30 or 60 seconds can be set.
- Backlight activates while the buttons are operated and goes off 30 or 60 seconds after the operation stops.



Various convenient functions

Displays setting status and Limitations

- The remote controller settings can be easily checked

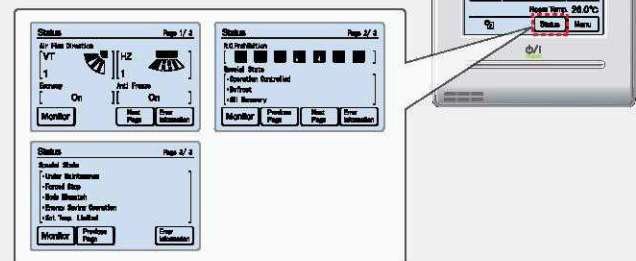

Summer Time display

- This function can be set easily from Menu screen



Child lock

- Lock / unlock method: Push the ON/OFF button and the screen (4 seconds)



Name Registration

- Remote controller names can be registered in the remote controller screen. This makes it easy to identify the indoor unit you want to control in the room.



Various energy saving control

Auto OFF Timer

- The indoor unit automatically turns off after a set time has passed.
- The time interval for which auto off works can be set.

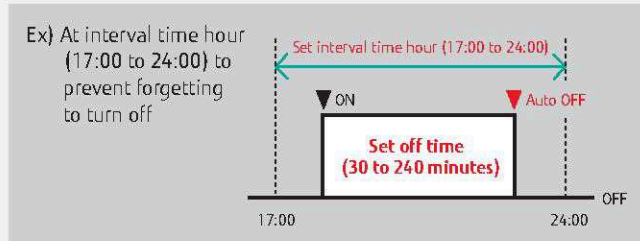

2 schedules Weekly Timer

- 2 schedules such as for the summer and winter can be set.
- 8 setting changeable per day of week (Setting items: On/Off, Temperature, Mode, Time)

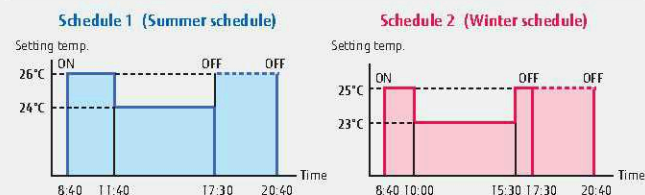
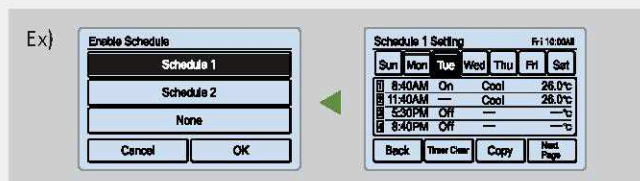

Set Temperature Auto Return

- The setting temperature automatically returns to the previous setting temperature.
- The time range in which the set temperature can be changed is 10 to 120 minutes.

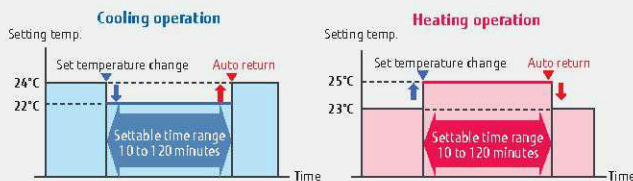

Set Temperature Upper and Lower Limit Setting

- The set temperature range can be set for each operation mode. (Cooling / Heating / Auto)

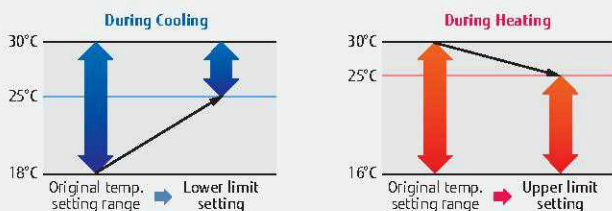

Specifications

Model name	UTY-RNRGZ1
Power Supply	DC 12V
Dimensions (H x W x D) (mm)	120 x 120 x 20.4
Weight (g)	220

DC12V is supplied by indoor unit.

Simplified installation

Uses non-polar 2-wire type

- The faulty wiring can be prevented by using non-polar 2-wire.

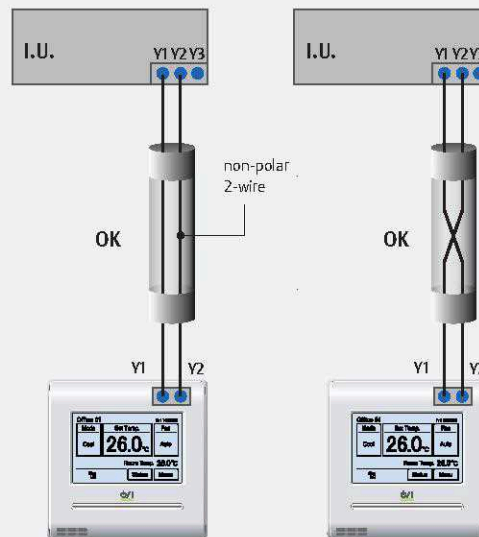

Auto Address Setting/Setting Position Notification

- Reduce errors and install time compared with the current specification Rotary SW
- When will be set remote controller groups, can also be set automatically new Wired remote controller address
- After auto address setting of new wired remote controller groups, what number can also confirm addresses

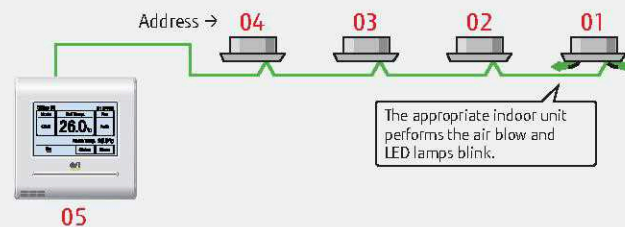

Easy Maintenance

Error History Display

- The errors that occur in the indoor unit or remote controller are saved as a history.
- A maximum of 32 error incidents can be saved.



Wired Remote Controller

Max. controllable
16
indoor units

UTY-RLRG



- Various timer setup (ON / OFF / WEEKLY) are possible.
- The room temperature can be controlled by detecting the temperature accurately with Built-in thermo sensor.
- When a failure occurs, the error code is displayed.
- Error history. (Last 16 error codes can be accessed.)
- 2-wire type

Functions

High performance and compact size

In addition to the individual control, weekly timer, and various energy saving controls can be realized using only one remote controller.



Auto-off timer

- The indoor unit automatically turns off after a set time has passed.

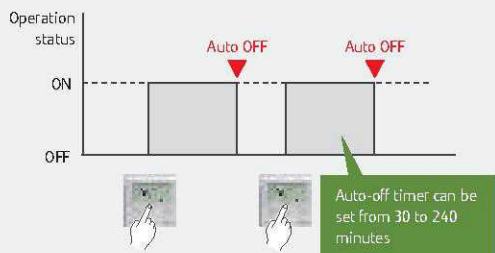

Weekly timer function

- Not only time setting On / Off, but also setting of the operation mode and set temperature can be set by Weekly timer function.

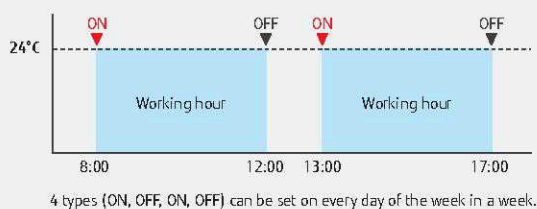

Specifications

Model name	UTY-RLRG
Power Supply	DC 12V
Dimensions (H x W x D) (mm)	120 x 120 x 17
Weight (g)	170

DC12V is supplied by indoor unit.

High visibility and easy operation

- "Mode", "Set Temp", and "Fan" are displayed at large size on the top screen.
- Each function to be set is indicated by an icon.
- Control guide is displayed and operation is simple and straightforward.

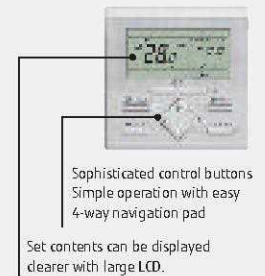

Set temperature auto return

- The setting temperature automatically returns to the previously set temperature.
- The time range in which the set temperature can be changed is 30 to 240 minutes.

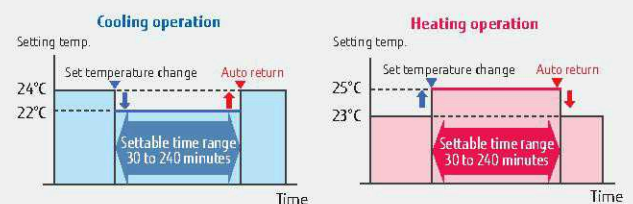

Set temperature upper and lower limit setting

- The set temperature range can be set for each operation mode. (Cooling / Heating / Auto)

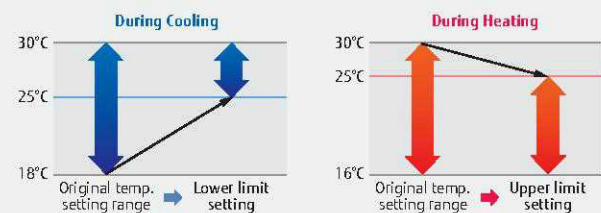

Simple Remote Controller

Max. controllable
16
indoor units

UTY-RSKG / UTY-RHKG (Without Operation mode)

Compact remote controller provides access to basic functions

- Up to 16 indoor units can be controlled with one remote controller.
- Suitable for hotels or offices as it is easily operated with no complex functions.



UTY-RSKG



UTY-RHKG
Without Operation mode

Functions

User-friendly operation

- Provides access to basic operations, such as Start / Stop, Fan control, Operation mode switching, and Room temperature setting.
- A large On / Off button is provided in the centre of the remote controller for easy operation.
- Can be used jointly with other individual control unit.
- Following an error display, diagnostics can be carried out on the controller.

Backlight

- Backlight enables easy operation in a darkened room.
- Backlight activates during all button operations, and lasts 10 seconds in Operation mode and 5 seconds in stop mode after a button is pressed.



Simple installation

Can be mounted on the European Mounting Box (Installation dimension: 60mm) or the JIS Built-in Box (Installation dimension: 83.5mm).



Functions summary

Model	UTY-RSKG	UTY-RHKG
Operation		
On / Off	●	●
Fan control	●	●
Operation mode	●	—*1
Room temp. setting	●	●

*1: "Operation mode" setting is not available.
It is recommend to use together with other type controller.

Specifications

Model name	UTY-RSKG	UTY-RHKG
Power Supply	DC 12V	
Dimensions (H x W x D) (mm)	120 x 75 x 14	
Weight (g)	90	

DC12V is supplied by the indoor unit.

Wireless Remote Controller

UTY-LNHG

Simple and sophisticated operations with a choice of 4 daily timers

- A single controller controls up to 16 indoor units.



Max. controllable
16
indoor units

Selectable
4
daily timers

Functions

Built-in daily timer

Select from 4 different timer programs :

On / Off / Program / Sleep

Program timer : The program timer operates the ON and OFF timer once within a 24 hour period.

Sleep timer : The sleep timer function automatically corrects the set temperature according to the time setting to prevent excessive cooling or heating during sleep hours.

Cooling operation/dry operation

When the sleep timer is set, the set temperature automatically rises 1°C every hour. The set temperature can rise up to a maximum of 2°C.

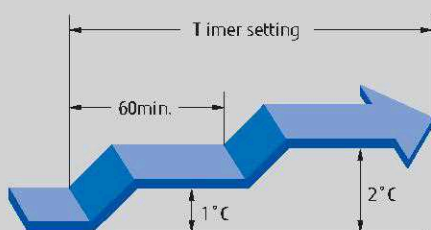

Heating operation

When the sleep timer is set, the set temperature automatically drops 1°C every 30 minutes. The set temperature can drop to a max. of 4°C.

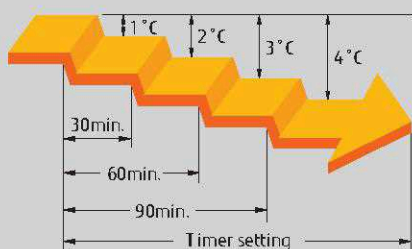

Easy installation and operation

Code selector switch prevents indoor unit mix-up. (Up to 4 codes can be set.)

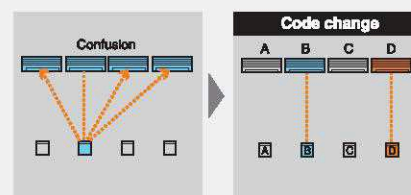

Wide and precise



Address setting

During installation work, address setting can be performed using the Wireless Remote Controller, thus eliminating manual switch setting.

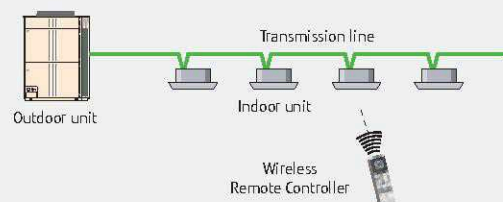

Specifications

Model name	UTY-LNHG
Power Supply	1.5V (R03 / LR03 / AAA) x 2
Dimensions (H x W x D) (mm)	170 x 56 x 19
Weight (g)	85

IR Receiver Unit

Max. controllable
16
indoor units

UTB-YWC

Necessary to control for all Duct types* by Wireless Remote Controller

*Only Large Airflow Duct can not be connected to IR Receiver Unit.

- Up to 16 indoor units can be controlled with one remote controller.
- Suitable for hotels or offices as it is easily operated with no complex functions.



Functions

Wiring connection



IR Receiver Unit

UTY-LRHGB1

Cassette type indoor unit can be controlled with Wireless Remote Controller

Functions

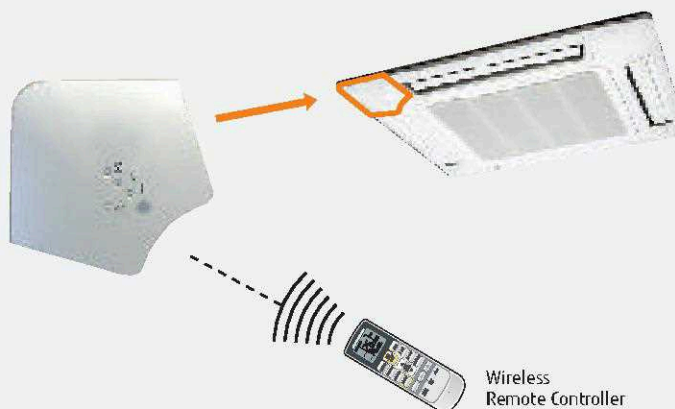

Specifications

Model name	UTB-YWC
Power Supply	DC 5V
Dimensions (H x W x D) (mm)	145 x 90 x 30
Weight (g)	150

Model name	UTY-LRHGB1
Power Supply	DC 5V
Dimensions (H x W x D) (mm)	193.9×193.9×31.2
Weight (g)	140

Group Remote Controller

UTY-CGGG

Group control of indoor units with simple operation

- Up to 8 remote controller groups can be controlled by one Group Remote Controller.
- Up to 64 Group Remote Controllers can be connected in one VRF network system.
- Network Converter (UTY-VGGXZ1) is required to connect Group Remote Controllers to a VRF network system.
(Network Converter allows up to 4 Group Remote Controllers)



Max. controllable
8
remote controller groups

Max. controllable
64
group R.C. in a VRF network system

Functions

Control up to 8 remote controller groups

Single Group Remote Controller controls and monitors up to 8 remote controller groups.

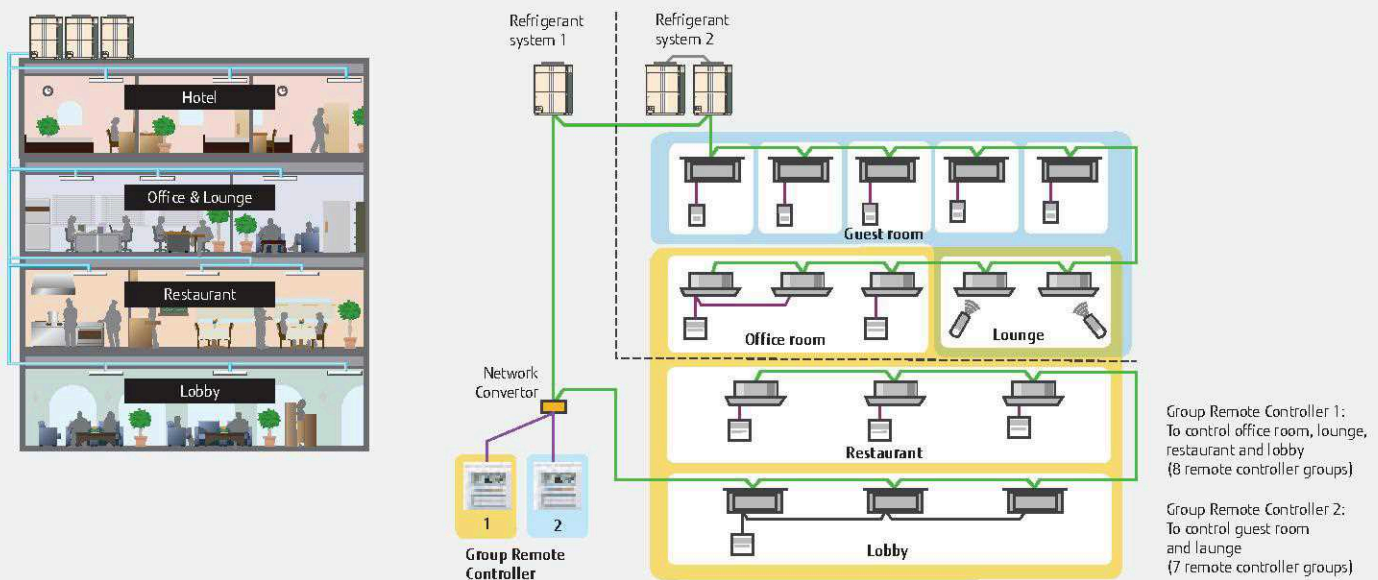

High performance and compact size

ON / OFF, Operating mode, Room temperature and Fan speed setting can be controlled / monitored centrally or individually.



Built-in weekly timers

The weekly timer is provided as a standard function.

1. The timer can be set up for up to 4 times per day. (On / Off, operating mode, set temperature)
2. Allows separate settings for each day of the week.

Specifications

Model name	UTY-CGGG
Power Supply	DC 12V
Dimensions (H x W x D) (mm)	120 x 120 x 18
Weight (g)	200

DC12V is supplied by a network converter.

Central Remote Controller

UTY-DCGG

Central control of small- and medium-sized buildings and tenants. The operation status of all connected indoor units can be viewed at a glance on a large LCD monitor to simplify individual control to batched control.

- Individual control and monitor of 100 indoor units
- 5 inch TFT color screen
- User friendly view and easy operation
- External input / output contact
- Detachable power supply unit
- Corresponds to 7 different languages (English, Chinese, French, German, Spanish, Russian, Polish)



Max. controllable
100
Indoor units

Max. controllable
16
groups

Functions

System overview

- It allows multiple indoor units grouping (Max.16 groups controlled)
- Interlock with external device

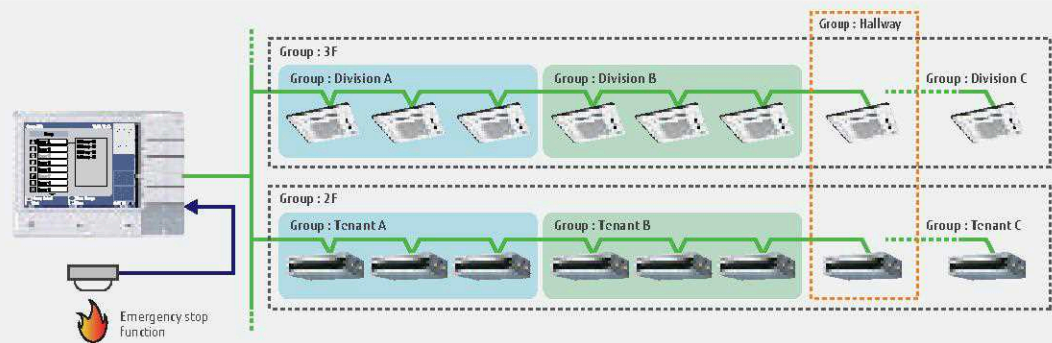

Functions

- Diverse control of indoor units
- Remote controller prohibition (All, On / Off, Mode, Temp, Timer, Filter)
- Weekly timer
- Error history
- Automatic dock adjustment

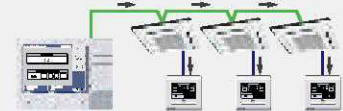
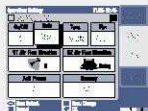

Easy Installation

- The control panel and power supply unit can be installed separately.
- For flexibility in installation, the Control panel can be built into the wall or fix on the wall.

Setting pattern 1

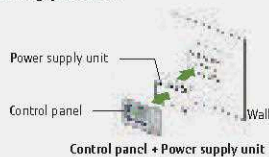

Setting pattern 2

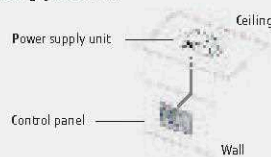

- Automatic or manual indoor unit registration

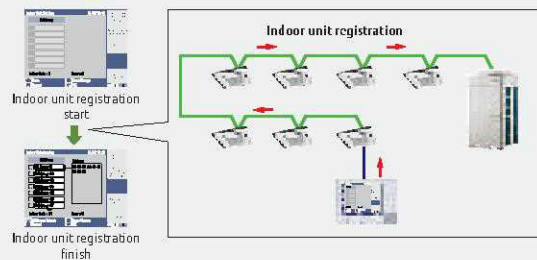

Specifications

Model name	UTY-CGGG	
	Control Panel	Power Supply Unit
Power Supply	DC 5 V	100-240V, 50-60Hz, Single phase
Dimensions (H x W x D) (mm)	120 x 162 x 25.7	99 x 135 x 39.2
Weight (g)	308	355
<PACKING LIST>		
Packing List	Control Panel / Power Supply Unit / Connecting cable, etc.	

Touch Panel Controller

Max. controllable
400
Indoor units

UTY-DTGGZ1 **NEW**

High visibility and easy operation via high resolution
7.5 inch TFT-LCD touch panel screen



- Large-sized 7.5-inch TFT color
- LCD Easy finger touch operation
- Stylish shape and design to suit all application
- Up to 400 indoor units can be controlled
- Selectable 2 display types (Icon / List) in monitoring mode
- Supports 7 different-languages ,English, Chinese, French, German, Spanish, Russian, Polish.
- Mounted with LAN interface for remote control & operation, external input / output with emergency stop and batch ON / OFF

Functions



Easy operation

- Large and wide-angled LCD is easily viewable even at a distance
- Easy-to-understand icon-driven Graphical User Interface (GUI)
- Wide range of simple-to-understand icons

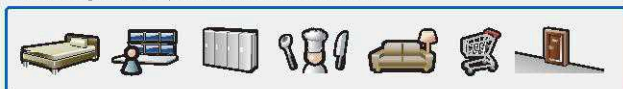

- Operation can be selected using your finger or the dedicated touch pen by pressing the appropriate on-screen icon
- Up-to-date status display
- Background color identifies current control operation Blue for monitoring, green for operational control

Easy maintenance

- Flat touch screen is easily cleaned
- Non-glare coating on touch panel controller minimizes fingerprint marking
- Easy-to-remove front cover



Easy installation

- Touch Panel Controller is easily mounted to the wall.
- Flat back surface allows to be installed wherever it is needed.
- No additional component is required for installation.



Up to 400 indoor units can be controlled

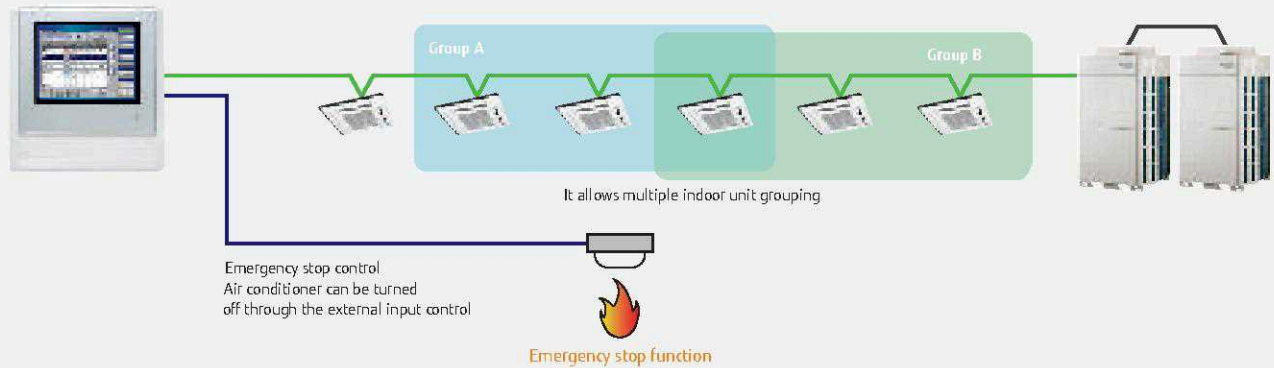

Diverse operation management



- Outdoor unit low noise setting
- Automatic clock adjustment
- Emergency stop function

Remote monitoring and operation

- Air conditioner can be monitored and controlled via LAN from PC.
- Error contents are notified automatically by E-mail at error occurrence to handle the trouble promptly.

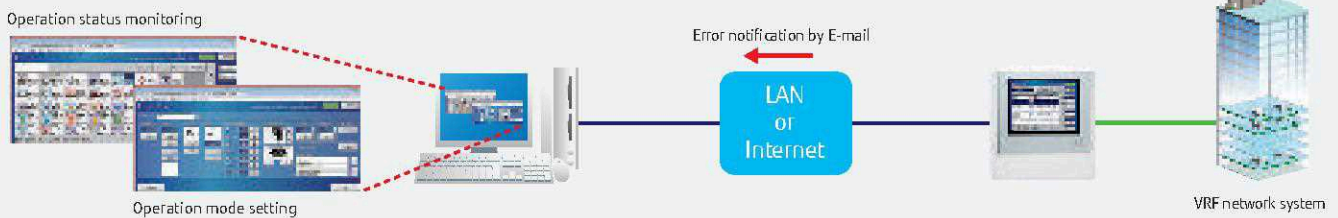

Electricity charge apportionment (Option: UTY-PTGXA)

- Electricity charge apportionment can be performed easily for the power consumed when billing users for air conditioning power charges.

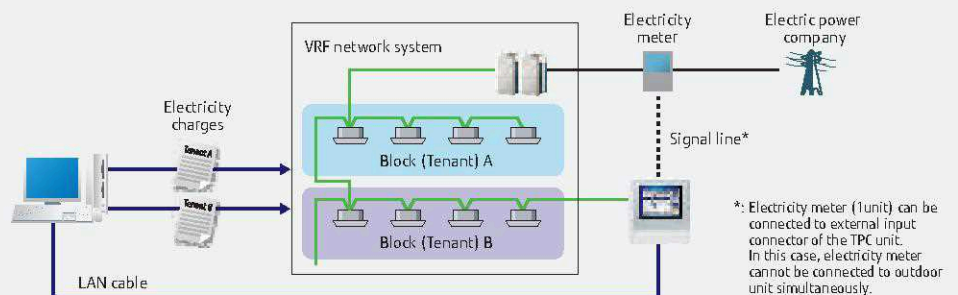

Specifications

Model name	UTY-DTGGZ1
Power Supply	100-240V 50/60Hz, Single phase
Dimensions (H x W x D) (mm)	260 x 246 x 54
Weight (g)	2,150
Interface	Transmission / LAN / USB / EXT IN / EXT OUT / Reset SW

System Controller Software

UTY-APGX

System Controller realizes the advanced integrated monitoring & control of VRF network system from small scale buildings to large scale buildings.

- Up to a maximum of 4 VRF network systems, 1600 indoor units, and 400 outdoor units can be controlled.
- In addition to air conditioning precision control function, central remote control, electricity charge calculation, schedule management, and energy saving functions are strengthened and building manager and owner needs are met.



Max. controllable
4
VRF network systems

Max. controllable
400
Outdoor units

Max. controllable
1,600
Indoor units

System Controller Lite Software

UTY-ALGX

System Controller Lite has standard functions sufficient for air conditioner management in small and medium scale buildings .

- Up to a maximum of 1 VRF network system, 400 indoor units, and 100 outdoor units can be controlled.
- In addition to air conditioning precision control function, a variety of management software is available as an option to give customers a wide range of choice.



Max. controllable
1
VRF network systems

Max. controllable
100
Outdoor units

Max. controllable
400
Indoor units

Functions

User friendly view and operation

- **Click & Operate :** The property is shown visually from the perspective most suitable for operation and operated accordingly (Click & Operate). You can select from among the 4 displays of site, building, floor, or list.
- **Freely define groups for batched control :** Indoor units can be freely grouped for simple batched control from a tree menu. Grouping by hierarchal structure, such as by section, division or department is possible.

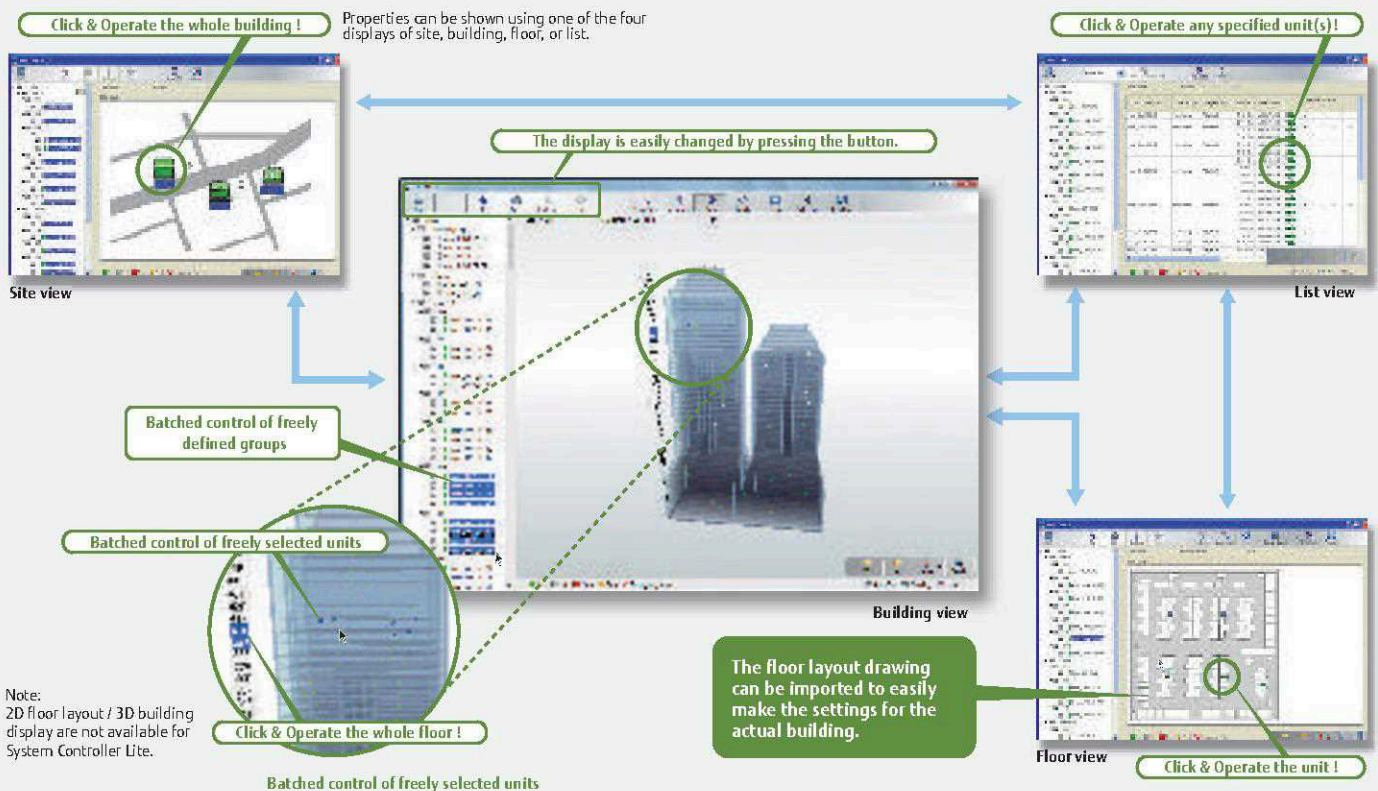

Diverse operation management & Data management Standard for System Controller and System Controller Lite

Schedule management

- Annual schedules can be set for each remote controller group / user defined group.
- Start / stop, operating mode, remote controller prohibition, and temperature settings can be set up to 143 times per day at 10 minute intervals for up to 101 configurations for each remote controller group.
- Settings can be made for periods straddling midnight.
- Allows programming of special settings for holidays, including public holidays, for a complete year.
- Low noise operation of outdoor unit can be scheduled.



Error display & E-mail notification

Error is notified with popup message, audible sound and E-mail real time when error occurs. Error for the past 1 year are logged and can be reviewed later.



Operating & control record

Displays the history of operation status and control.



Diverse control of indoor and outdoor unit

- Indoor unit operation state, operation mode, etc. are displayed
- Indoor unit start / stop and operation mode switching
- Room temperature set point limitation
- Outdoor unit low noise setting



Data base import/export

Imports/exports registration data, layout data, and image data. Only the administrator can make this setting.



Remote controller prohibition

This prohibits changes to the operation mode, temperature, start/stop, etc.



Automatic clock adjustment

The time setting of each controller can be set in batch automatically.

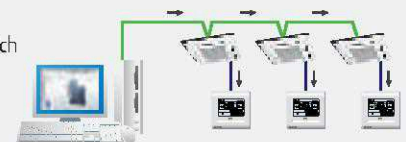

Electricity charge apportionment Standard for System Controller Option for System Controller Lite UTYP-PLGXA1

Electricity charge apportionment calculation framework

Suppose you want to find the power consumed by the air conditioners of each tenant from the electricity charge for each month. With electricity charge apportionment function, used energy apportionment ratio will be provided, calculating in detail the energy consumed by the units used by each tenant. This information is then used to calculate the charges for the electricity consumed for air conditioning by each tenant from the total electricity charges in the bill from the electric power company. (See figure at right)

The detailed calculation takes into consideration such things as unused rooms and nighttime electricity charges and shows them in a charges calculation sheet.

System Configuration Example

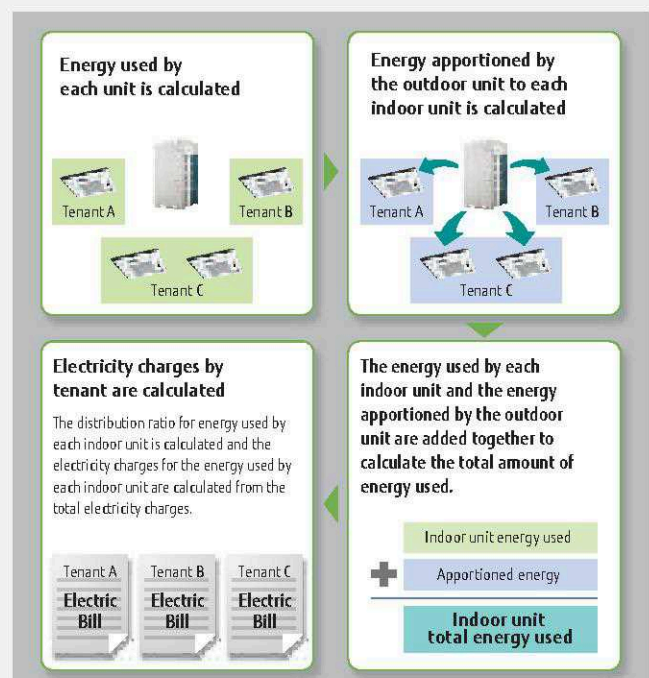
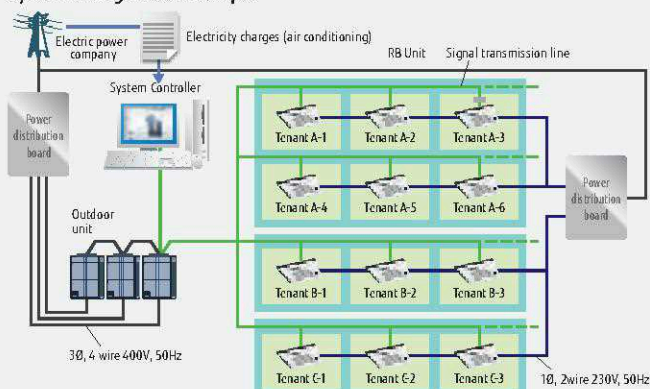

Remote management

Standard

for System Controller

Option

for System Controller Lite UTY-PLGXR1

System Controller may be used on site or remotely over various networks for remote central control. System Controller requires 2 softwares working together. VRF Controller runs on site and communicate with VRF system. VRF Explorer runs remotely and provides user interface and communicate with the VRF Controller. VRF Controller and VRF Explorer program may run in a single PC or in different PCs separated by network. By using VRF Explorer software, one PC can perform central control of 10 VRF system sites with max. 20 buildings per site.

On site central control

Max. 4 VRF network systems per site

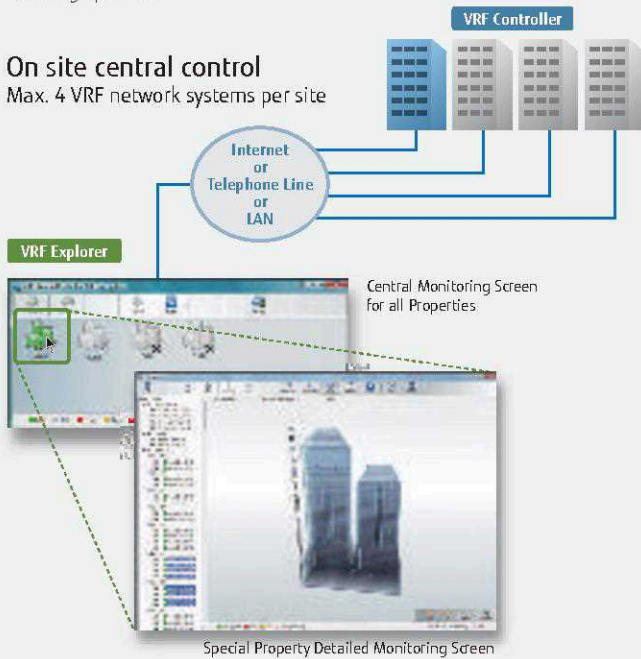

Remote central control

1 VRF Explorer can control or monitor up to 10 sites.

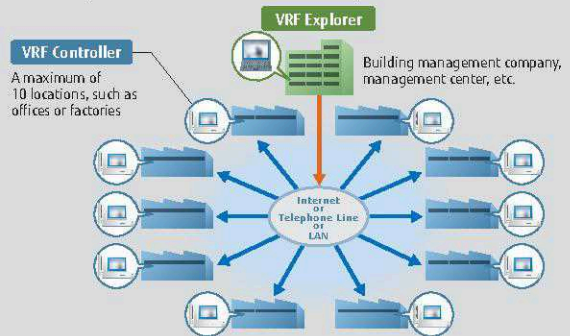

1 VRF Controller can be monitored from any number of VRF Explorers (Up to 5 connections simultaneously).

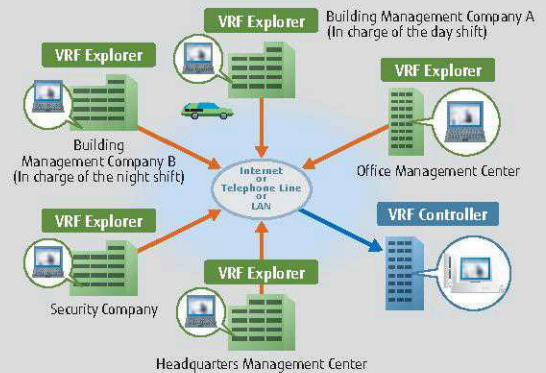

Energy saving management

Option

for System Controller UTY-PEGX

Option

for System Controller Lite UTY-PLGXE1

A variety of energy saving operations can be set and managed depending on the season, weather, and time period. Excellent energy saving operation is performed while keeping users comfortable.

Energy saving graph data: This graph compares the electricity consumption with the previous month and previous year to make it easy to analyze the energy saving effect.



Energy Saving Management Main Screen

Indoor unit rotation operation

The operation of indoor units can be automatically rotated within a group in accordance with the set annual schedule to reduce power consumption while maintaining comfort. The indoor unit operation stoppage rate can be selected.

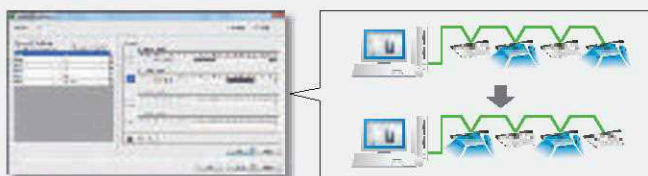

Indoor unit rotation screen

Peak cut operation

A power meter is connected to detect the total power consumption while shifting the indoor unit set temperature, set the indoor unit forced thermostat off, and taking other measures to carefully control the power consumed while maintaining comfort and conducting control to maintain the target power consumption set for each time. The indoor units to be controlled can be freely grouped and the control level can be set.

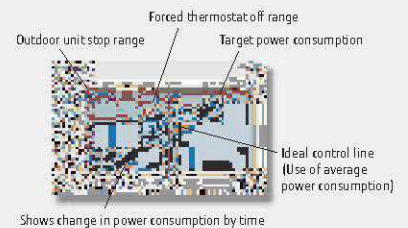

Outdoor unit capacity save

Outdoor unit capacity save switches the outdoor unit capability upper limit to suppress power consumption during hot summers and cold winters by averaging the power saving effect of each refrigerant system. You can select from 50% or more of the capacity upper limit.

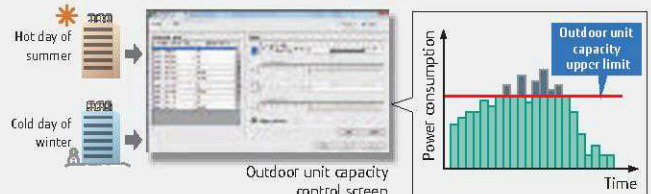

Outdoor unit capacity control screen

FUNCTIONS SUMMARY

Function	Type	System controller		System controller lite			
		UTY-APGX	Option UTY-PEGX	UTY-ALGX	Option UTY-PLGXR1	Option UTY-PLGXA1	Option UTY-PLGXE1
System specification	Max. VRF networks supported	4	-	1	-	-	-
	Max. indoor unit/ remote controller groups per VRF network	400	-	400	-	-	-
	Max. outdoor units per System controller	100	-	100	-	-	-
Site supervision	Max. indoor units / remote controller groups per System controller	1600	-	400	-	-	-
	Max. outdoor units per System controller	400	-	100	-	-	-
	Multi site display	10	-	10	-	-	-
	Number of building / 1 site	20	-	-	-	-	-
	Number of floor per 1 site	200	-	-	-	-	-
	Number of floor per 1 building	50	-	-	-	-	-
	3D graphical layout view	○	-	-	-	-	-
	2D graphical layout view	○	-	-	-	-	-
	List display	○	-	○	-	-	-
	Tree display	○	-	○	-	-	-
	Group display	○	-	○	-	-	-
Error management	Error notification	○	-	○	-	-	-
	Audible alarm	○	-	○	-	-	-
	Error e-mail notification	○	-	○	-	-	-
History	Error history	○	-	○	-	-	-
	Operation history	○	-	○	-	-	-
	Control history	○	-	○	-	-	-
Operation control	Individual control	On/Off	○	-	○	-	-
		Operation mode	○	-	○	-	-
		Room temperature	○	-	○	-	-
		Fan speed	○	-	○	-	-
		Air flow direction	○	-	○	-	-
		Economy mode	○	-	○	-	-
		Room temperature set point limitation	○	-	○	-	-
		Test operation	○	-	○	-	-
	Individual management	Antifreeze	○	-	○	-	-
		Outdoor unit low noise setting	○	-	○	-	-
		Remote control prohibition setting	○	-	○	-	-
	Other	Temperature upper and lower limit setting	○	-	○	-	-
		Filter sign reset	○	-	○	-	-
		Memory operation	○	-	○	-	-
Schedule	Pattern operation	○	-	○	-	-	
	Annual Schedule	○	-	○	-	-	
	Special day setting	○	-	○	-	-	
	On / off per day	72	-	72	-	-	
	On / off per week	504	-	504	-	-	
	Day off	○	-	○	-	-	
	Min. unit of timer setting (Minutes)	10	-	10	-	-	
	Low noise mode Weekly schedule	○	-	○	-	-	
Remote management	Remote monitoring	○	-	-	○	-	
	Remote operation control	○	-	-	○	-	
	Remote function setting	○	-	-	○	-	
Electricity charge apportionment	Apportionment charge/bill calculation	○	-	-	-	○	
	Tenant (block) setting	○	-	-	-	○	
	Common facilities apportionment setting	○	-	-	-	○	
	Rated power consumption allotment setting	○	-	-	-	○	
	Individual calculation at cooling and heating	-	○*	-	-	○	
	Electricity meter supported	-	○	-	-	○	
Energy saving management	Indoor unit rotation	-	○	-	-	○	
	Peak cut control	-	○	-	-	○	
	Outdoor unit capacity save	-	○	-	-	○	
	Record of energy saving operation	-	○	-	-	○	
	Energy saving information	-	○	-	-	○	
	Power consumption monitor	-	○	-	-	○	
Others	Electricity meter supported	-	○	-	-	○	
	Database import/export	○	-	○	-	-	
	Automatic clock adjustment	○	-	○	-	-	
		7 languages	-	7 languages	-	-	

○: Available. - : Not available. *:Power calculation application software is necessary, please contact the local FGL representative.

Personal computer system requirements

	System Controller	System Controller Lite				
Operating system	<ul style="list-style-type: none"> Microsoft® Windows Vista® Home Premium (32-bit) SP2, Windows Vista® Business (32-bit) SP2 Microsoft® Windows® 7 Home Premium (32-bit or 64-bit) SP1, Windows® 7 Professional (32-bit or 64-bit) SP1 Microsoft® Windows® 8.1 (32-bit or 64-bit), Windows® 8.1 Pro (32-bit or 64-bit) Microsoft® Windows® 10 Home (32-bit or 64-bit), Windows® 10 Pro (32-bit or 64-bit) [Supported languages] English, Chinese, French, German, Russian, Spanish, and Polish	<ul style="list-style-type: none"> Microsoft® Windows Vista® Home Premium (32-bit) SP2, Windows Vista® Business (32-bit) SP2 Microsoft® Windows® 7 Home Premium (32-bit or 64-bit) SP1, Windows® 7 Professional (32-bit or 64-bit) SP1 Microsoft® Windows® 8.1 (32-bit or 64-bit), Windows® 8.1 Pro (32-bit or 64-bit) Microsoft® Windows® 10 Home (32-bit or 64-bit), Windows® 10 Pro (32-bit or 64-bit) [Supported languages] English, Chinese, French, German, Russian, Spanish, and Polish				
CPU	Intel® Core™ i3 2 GHz or higher					
Memory	• 2 GB or more (for Windows Vista® and Windows® 7 [32-bit])	• 4 GB or more (for Windows® 7 [64-bit], Windows® 8.1, and Windows® 10)				
HDD	40 GB or more of free space					
Display	1024 x 768 or higher resolution					
Interface	<ul style="list-style-type: none"> Ethernet port (for getting access to the Internet using LAN) or Modem (for getting access to the Internet using Public Telephone Line) USB ports (Maximum of 6 ports) (Required only for the Server PC that works as VRF Controller) - Maximum of 2 USB ports are required for WibuKey connection - Maximum of 4 USB ports are required for Echelon® U10 USB Network Interface * Maximum number of required USB port depends on the applicable system configuration. 	<ul style="list-style-type: none"> Ethernet port (for getting access to the Internet using LAN) or Modem (for getting access to the Internet using Public Telephone Line) USB ports (Maximum of 5 ports) (Required only for the Server PC that works as VRF Controller) - Maximum of 4 USB ports are required for WibuKey connection - 1 USB port is required for Echelon® U10 USB Network Interface * The maximum number of required USB port depends on the applicable system configuration. 				
Graphic accelerator	Microsoft® DirectX® 9.0c compatible					
Software	Adobe® Reader® 9.0 or later					
Optical drive	DVD-ROM drive					
<Packing list>						
Type	For System controller		For System controller Lite			
	System controller	Option Energy manager	System Controller Lite	Option		
	UTY-APGX	UTY-PEGX	UTY-ALGX	Remote access UTY-PLGXR1	Electricity charge apportionment UTY-PLGXA1	Energy saving UTY-PLGXE1
DVD-ROM	1	1	1	-	-	-
WibuKey*1 (Software protection key)	1	1	1	1	1	1

*Personal computer that satisfies the following system requirements

*Echelon® U10 USB Network Interface – TP/FT-10 Channel (Model number: 75010R) (Required for each VRF Network.)

*1: Software protection key to be inserted in a USB slot running System Controller or System Controller Lite.

System Controller or System Controller Lite may only run on a PC with Wibu Key. However, WibuKey is not required for remote VRF Explorer software.

BACnet® Gateway

UTY-ABGX

- It is possible to connect medium to large sized BMS to VRF network system via BACnet®, a global standard for open networks.
- A maximum of 1600 indoor units with 4 VRF network systems (a maximum of 400 indoor units & 100 outdoor units for one network system) can be connected to one BACnet® Gateway.
- It is possible to control or monitor VRF network system from BMS via BACnet® Gateway.
- Compatible with BACnet® (ANSI / ASHRAE-135-2004) application specific controller (B-ASC).
- Compatible with BACnet®/IP over Ethernet.
- Scheduling function, Alarm & Event functions as well as Electricity Change Apportionment function are provided in BACnet® Gateway.
- Connection between VRF network system to personal computer is possible via small U10 USB interface. However, both U10 USB interface & personal computer are field supplied items.
- Corresponds to 7 different languages, English, Chinese, French, German, Spanish, Russian, Polish.



Max. controllable
4
VRF network systems

Max. controllable
400
Outdoor units

Max. controllable
1,600
Indoor units

Functions

Installation example

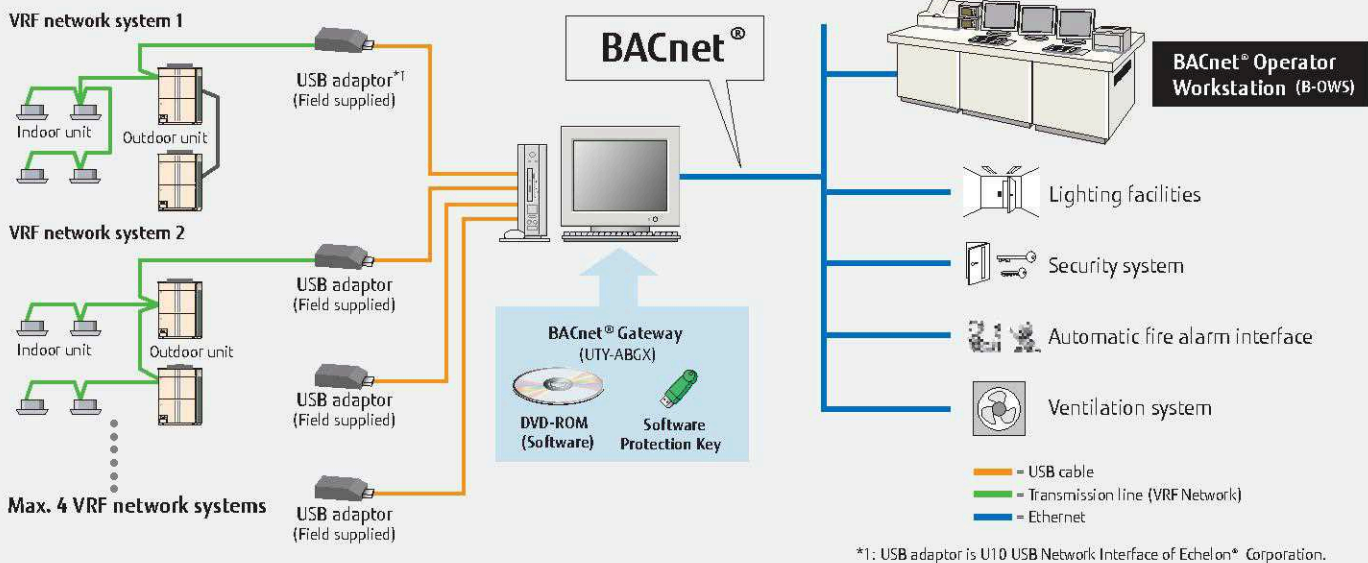

Personal computer system requirements

	UTY-ABGX
Operating system	<ul style="list-style-type: none"> • Microsoft® Windows Vista® Home Premium (32-bit) SP2, Windows Vista® Business (32-bit) SP2 • Microsoft® Windows® 7 Home Premium (32-bit or 64-bit) SP1, Windows® 7 Professional (32-bit or 64-bit) SP1 • Microsoft® Windows® 8.1 (32-bit or 64-bit), Windows® 8.1 Pro (32-bit or 64-bit) • Microsoft® Windows® 10 Home (32-bit or 64-bit), Windows® 10 Pro (32-bit or 64-bit) [Supported languages] English, Chinese, French, German, Russian, Spanish, and Polish
CPU	Intel® Core™ i3 2 GHz or higher
Memory	<ul style="list-style-type: none"> • 2 GB or more (for Windows Vista® and Windows® 7 [32-bit]) • 4 GB or more (for Windows® 7 [64-bit], Windows® 8.1, and Windows® 10)
HDD	40 GB or more of free space
Display	1024 x 768 or higher resolution
Interface	<ul style="list-style-type: none"> • Ethernet port (for getting access to the Internet using LAN) • USB ports (Maximum of 5 ports) <ul style="list-style-type: none"> - 1 USB port is required for WibuKey connection - Maximum of 4 USB ports are required for Echelon® U10 USB Network Interface * Maximum number of required USB ports depends on the applicable system configurations.
Software	Adobe® Reader® 9.0 or later
Optical drive	DVD-ROM drive

<Packing list>

Name and shape	Quantity	Application
DVD-ROM	1	Includes the software and manuals for BACnet® Gateway.
Wibu Key (Software protection key)	1	Software protection key to be connected to USB port on the BACnet®-installed PC. BACnet® Gateway runs only on a PC with WibuKey.

- Personal computer that satisfies the following system requirements
- Echelon® U10 USB Network Interface – TP/FT-10 Channel (Model number: 75010R) (Required for each VRF Network.)

Network Convertor for LONWORKS®

UTY-VLGX

- For connection between VRF network system and a LONWORKS® open network for management of small to medium-sized BMS and VRF network system.
- The UTY-VLGX permits central monitoring and control of a VRF network system from a BMS through a LONWORKS® interface.
- Up to 128 Indoor units can be connected to one Network Convertor for LONWORKS®



Max. controllable

4

Units to BMS

Max. controllable

100

Outdoor units

Max. controllable

128

Indoor units

Functions

Installation example



General-purpose building control computer (LONWORKS® device)

- Lighting facilities
- Security system
- Automatic fire alarm interface
- Ventilation system

LONWORKS® Network

Max. 4 Network Convertor

Max. 100 outdoor units

Max. 128 indoor units

Max. 100 outdoor units

Max. 128 indoor units

VRF network system 1

VRF network system 2

Specifications

Model name	UTY-VLGX
Power Supply	208-240V 50/60Hz, Single phase
Power Consumption (W)	4.5
Dimensions (H x W x D) (mm)	67 x 288 x 211
Weight (g)	1,500

Transmission specifications (BMS side)

Transmission speed	78 kbps
Transceiver	FT-X1 (Echelon® Corporation)
Transmission way form	Free topology
Terminal resistor	None (It attaches at the terminal of a network.)

Dimensions (Unit: mm)

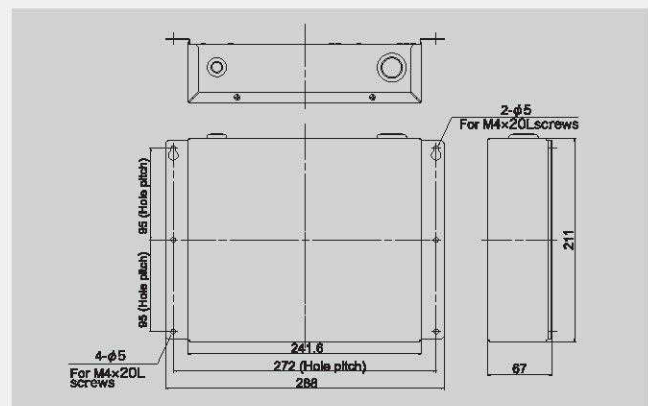

External Switch Controller

UTY-TEKX

Air conditioner switching can be controlled by connecting other sensor switches

- In combination with a field supply Card-Key Switch or other sensor, the External Switch Controller allows control of the ON / OFF, Room temperature, Fan speed and Master control functions. This makes this product suitable for installations such as hotel rooms.
- Card-key or other sensor switches are available as a field supplied parts.

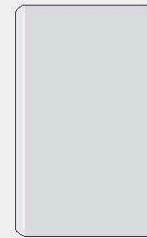

Functions

Installation example

Auto mode operation, which switches the cooling and the heating automatically, is enabled by using the sensor switch and External Switch Controller.

Note: All indoor units will operate in the same mode.

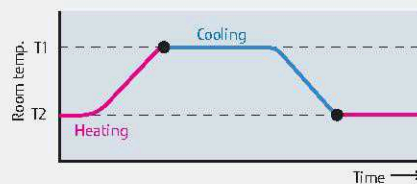
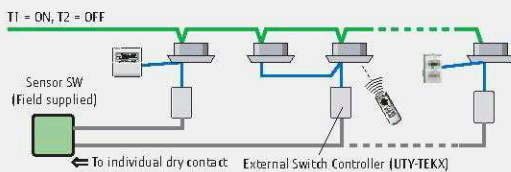

Note 1. Please choose a thermosensor switch which can be set up for T1 and T2.
 Note 2. The remote controller's operation is prior to the auto mode operation.

Electrical wiring

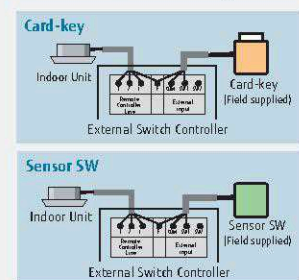

Signal Amplifier

UTY-VSGXZ1

- Transmission Line length can be extended up to 3,600m with multiple Signal Amplifiers.
- Up to 40 signal amplifiers can be installed in a VRF network system.
- A signal amplifier is required,
 - (1) When the total wiring length of the transmission line exceeds 500m.
 - (2) When the total number of units on the transmission line exceeds 64.



Functions

Installation example

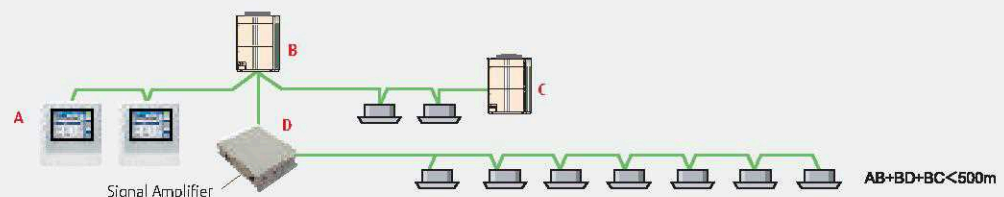

Specifications

Model name	UTY-TEKX
Power Supply	DC 12V
Dimensions (H x W x D) (mm)	120 x 75 x 30
Weight (g)	100

DC12V is supplied by indoor unit.

Model name	UTY-VSGXZ1
Power Supply	208-240V 50/60Hz, Single phase
Power Consumption (W)	4.5
Dimensions (H x W x D) (mm)	67 x 288 x 211
Weight (g)	1,500

Network Convertor

UTY-VGGXZ1

- This Network Convertor is to be used for connecting single split system or Group Remote Controller (UTY-CGGY / UTY-CGGG) with the VRF network system.
- Please select the function by switching the dip switch during the installation.

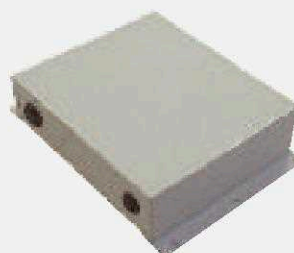

Max. controllable
16
single indoor
units

Max. controllable
4
Group Remote
Controllers

Functions

Used for connecting single split system

- Split type systems can be centrally controlled from Touch Panel Controller or System Controller through connection to the VRF's network convertor.
- On / Off Control, Master control, Room temperature and Fan speed setting via the Network Convertor are available.
- One Network Convertor can be used to connect and control up to 16 single units.

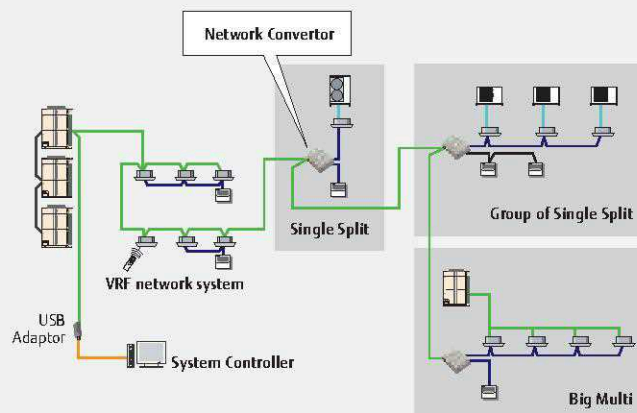

Please consult your distributor for connectable split type air conditioner.
Up to 100 Network Convertors may be connected in single VRF network system.
One Network Convertor is considered as a single refrigerant system, irrespective of the number of connected single models.

Used for connecting Group Remote Controller

4 Group Remote Controllers can be connected to a single Network Convertor (UTY-VGGXZ1).

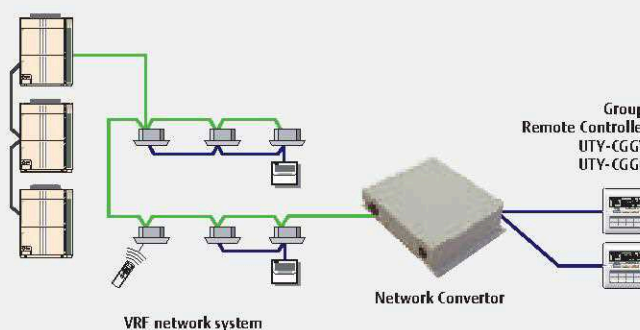

* 2 refrigerant circuits can be covered by a single Network Convertor (UTY-VGGXZ1).
Up to a total of 16 Network Convertors (UTY-VGGXZ1) and System Controller adaptors can be connected in a single VRF network system.

Specifications

Model name	UTY-VGGXZ1
Power Supply	208-240V 50/60Hz, Single phase
Power Consumption (W)	8.5
Dimensions (H x W x D) (mm)	67 x 288 x 211
Weight (g)	1,500

Network Convertor

Max. controllable
16
single indoor
units

Max. controllable
100
Network
Convertors

UTY-VTGX (DC power supply type) **NEW**

UTY-VTGXV (AC power supply type) **NEW**

- The network convertors are required when connecting single split system to VRF network system.
- Compact and light weight design
- Connectable to both types of 2-wire and 3-wire remote controllers



UTY-VTGX
DC power supply type



UTY-VTGXV
AC power supply type

Functions

Installation example

- 2 types of 1 remote controller type and 2 remote controllers type are available.
- Power supply (AC220-240V, 50/60Hz) is required for 2 remote controllers type.

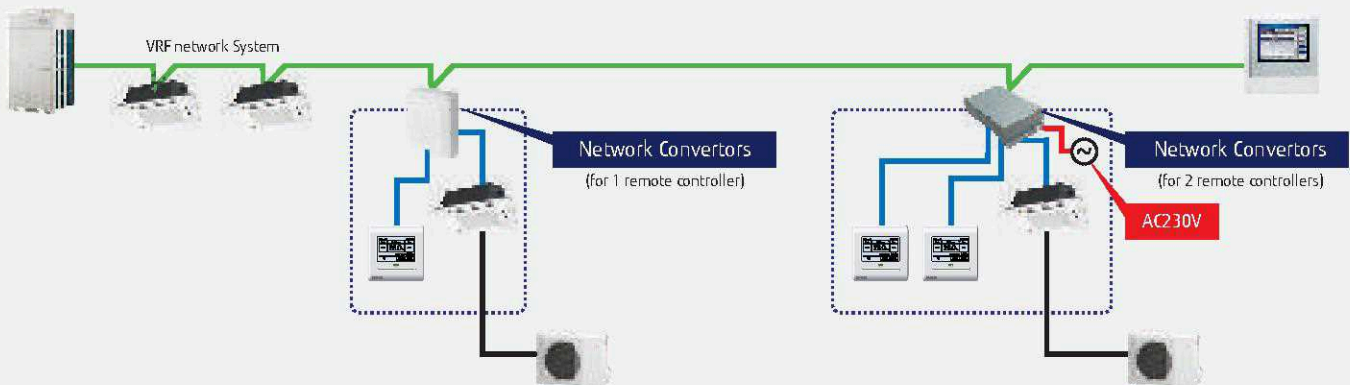

- 2-wire and 3-wire type of the wired remote controller can be connectable.
- Power supply (AC220-240V, 50/60Hz) is required for 2 remote controllers type.

- A central control can be provided for the single split systems. (Up to 100 units of Network Converter is connectable in one VRF network system)



Specifications

Model name	UTY-VTGX		UTY-VTGXV
Power Supply	polar 3-wire DC12V	non-polar 2-wire DC12V	220-240V 50/60Hz, Single phase
Input power (W)	Max. 1.2		Max. 3
Dimensions (H x W x D) (mm)	43 x 117 x 140		54 x 260 x 150
Weight (g)	250		1,100

MODBUS® Convertor

UTY-VMGX **NEW**

The MODBUS Convertor allows a complete integration of air conditioners into MODBUS Networks.

- Compact and lightweight design
- Direct connection to MODBUS Network
- Up to 128 indoor units can be controlled in one MODBUS Convertor
- The MODBUS Convertor permits central monitoring and control of air conditioners from BMS or Central Controller.

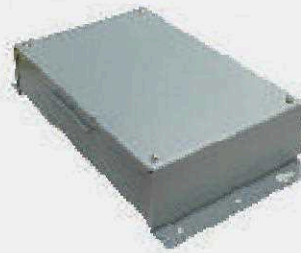

- Max. connectable
9
units to one VRF
- Max. controllable
100
outdoor units
- Selectable
128
indoor units

Functions

The Solution for integrating VRF Systems into small and medium sized buildings by Modbus method.

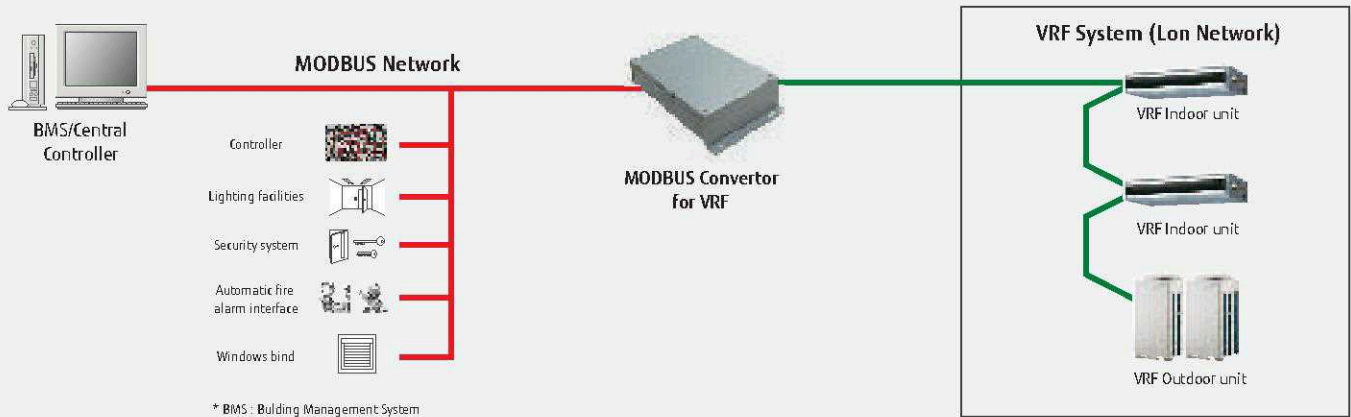

Connectable MAX 9

Up to 9 convertors can be connected to a VRF network. The simultaneous controls such as ON/OFF or temperature settings can be done for each zone.

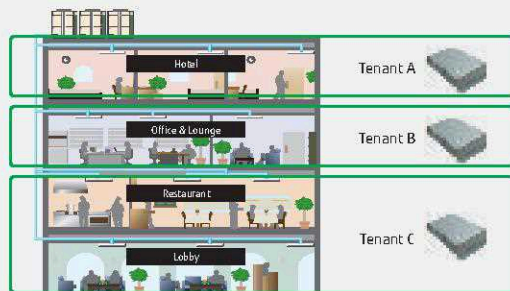

Traceability of sources of connection error

It is easy to locate the source of error if any connection errors should occur after completion of installation works.

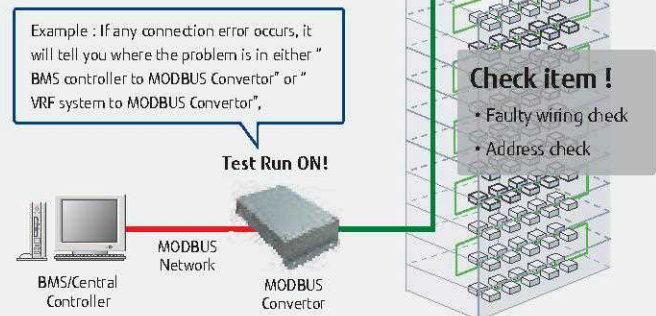

Specifications

Model name	UTY-VMGX
Power Supply	220-240V 50/60Hz, Single phase
Input power (W)	Max. 2
Dimensions (H x W x D) (mm)	54 x 260 x 150
Weight (g)	1,100

Service Tool Software

UTY-ASGX

Extensive monitoring and analysis functions for installation and maintenance.



Max. Monitor
100
Outdoor units

Max. Monitor and control
400
Indoor units

- Operation status can be checked and analyzed to detect even the small abnormalities.
- Data collected and stored on site can be checked later, off-line, off-site for more detail analysis.
- One VRF network system with maximum number of up to 400 units can be monitored and controlled.
- Operation status and various sensor information can be monitored and checked real time in the form of list, refrigerant circuit diagram, graphs as well.
- Simple operation control functions are useful during maintenance.
- The recent error history can be retrieved from units on demand to perform analysis on the cause of the error, after connecting Service Tool to the VRF network system.
- Commissioning tool supports test runs, data storage for each unit and saving of data as CSV files, which may be formatted to create commissioning report.
- Connectable to any point of transmission line with USB adaptor*1 (field supplied)
- Connection between VRF network system to personal computer is possible via small U10 USB interface. However, both U10 USB interface & personal computer are field supplied items.
- 14 advanced functions are available for the VR-II series for through servicing and through shooting.
- The operating state (Solenoid valve) of RB unit can be checked.

* 1: Service Tool (UTY-ASGX) will only support USB type network adaptor and will not support transmission adaptor of the traditional type(UTR-YTMA)

Wiring connection

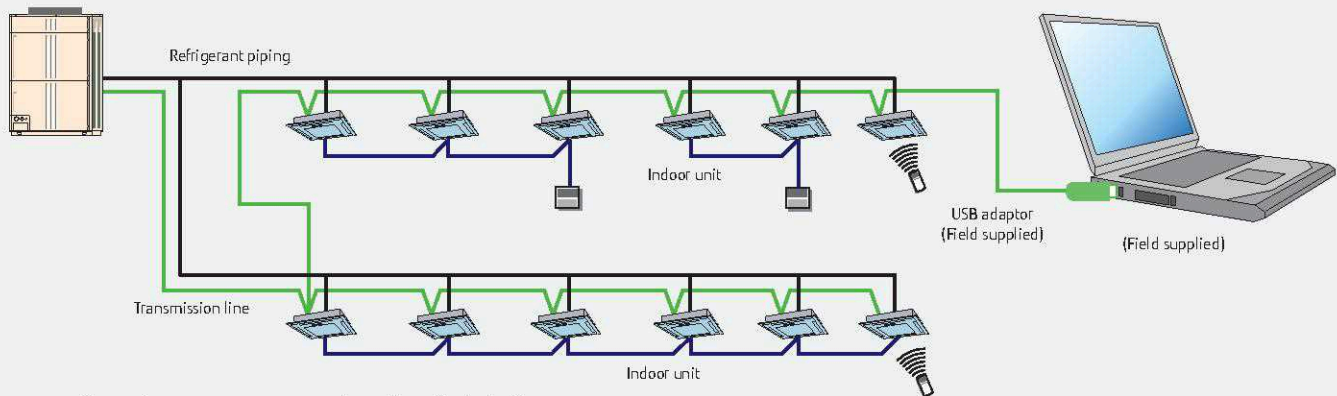

*USB Adaptor is U10 USB Network interface of Echelon® Corporation.

Functions

1) System List

Displays the overall operation status of all or specified units in the system in a list form.



2) Equipment Detail (Diagram)

Displays the detail information for sensor values, electrical components etc. for the specified units in schematic. The information here can be used along with the detail information in list form, to check the operation status of units and make detail analysis on the cause, in case an error occurs.



3) Equipment Detail (List)

Displays the detail information for sensor values, electrical components etc. of units in a specified refrigerant system in list form. The information here can be used along with the detail information in diagram form, to check the operation status of units and make detail analysis on the cause, in case an error occurs.



4) Operation History

The indoor units or outdoor unit operation history can be recorded. The displayed operation history can be printed out and saved to a CSV file.



5) Error History

Displays the error information for each unit. The error information can sequentially be displayed up to 50 items as they occur starting with the latest error.

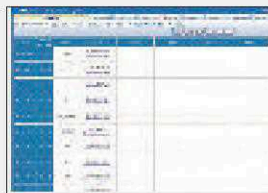

6) Remote File Download

Operation and error history data can be downloaded. Only the required data may be downloaded specifying the refrigerant system, unit and time range.

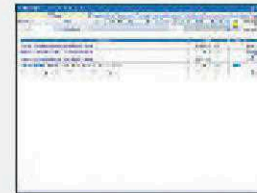

7) Commissioning Tool

Test run commands can be executed with this tool. During test running, the outdoor unit / indoor unit sensor data can be saved (commissioning log data). After the end of test running, this data can be exported in CSV file format.

8) Network Topology Analyzer *

A list of units connected to the VRF system network is displayed in network segments in tree form.



9) Remote Setting *

Function (Field) Setting for indoor unit is realized remotely



10) System Time Setting *

An arbitrary time is set for all the remote controllers within the system.

11) Central Release *

The operation setting restriction function of the indoor units set from the controller can be forcibly released. (remote controller inhibit, temperature upper/lower limit setting)

12) Model Name Writer *

An arbitrary model name can be written to the target unit.

13) Error Memory Reader *

When an error occurs at an outdoor unit, the operation data records before the error are acquired over a network and saved to a CSV file.

14) Time Guard Information *

Reference data for judging the maintenance period of indoor and outdoor units (compressor, FAN, etc. integrated time) is output to a CSV file.

Note: To perform "Error Memory Reading", Service Tool and the corresponding outdoor unit must be connected directly with each other. Refer to the Operation Manual of the Service Tool for detail.

*: Supported by Ver. 1.1 or later

Personal computer system requirements

UTY-ASGX		
Operating system	<ul style="list-style-type: none"> • Microsoft® Windows Vista® Home Premium (32-bit) SP2, Windows Vista® Business (32-bit) SP2 • Microsoft® Windows® 7 Professional (32-bit or 64-bit) SP1 • Microsoft® Windows® 8.1 Pro (32-bit or 64-bit) • Microsoft® Windows® 10 Pro (32-bit or 64-bit) 	
CPU	1 GHz or higher	
Memory	<ul style="list-style-type: none"> • 1 GB or more (for Windows Vista®, Windows® 7 [32-bit], Windows® 8.1 [32-bit], and Windows® 10 [32-bit]) • 2 GB or more (for Windows® 7 [64-bit], Windows® 8.1 [64-bit], and Windows® 10 [64-bit]) 	
HDD	10 GB or more of free space	
Display	1024 x 768 or higher resolution	
Interface	<ul style="list-style-type: none"> • 2 USB ports - 1 USB port is required for WibuKey connection - 1 USB port is required for Echelon® U10 USB Network Interface 	
Software	Internet Explorer® 8, 9, 10 or 11 / Adobe® Reader® 9.0 or later	
Optical drive	DVD-ROM drive	
<Packing list>		
Name and shape	Quantity	Application
DVD-ROM	1	Includes the software and manuals
Wibu Key (Software protection key)	1	Software protection key to be connected to USB port on the Service Tool-installed PC. These products runs only on a PC with WibuKey.

• Personal computer that satisfies the following system requirements
 • Echelon® U10 USB Network Interface – TP/FT-10 Channel (Model number: 75010R) (Required for each VRF Network.)

Web Monitoring Tool Software

VRF network systems can be supported
4

Max. Monitor Outdoor units
400

Max. Monitor and control Indoor unit can be monitored
1,600

UTY-AMGX

- Troubleshooting is performed by monitoring each unit remotely during periodical system checks off-site.
- Operation status can be checked and analyzed to detect even the smallest abnormalities.
- Four VRF network systems each with 400 units, with maximum number of up to 1,600 units can be monitored and controlled.
- Operation status and various sensor information can be monitored and checked real time in the form of list, refrigerant circuit diagram, and graphs as well.
- The monitoring data in a remote side can be optionally downloaded. And, this data can be displayed in off-line mode of the Service Tool.
- Error notification can be automatically transmitted to several locations using the internet*¹.
- Monitoring side computer is not required to install special software, requires only general web browser.
- Connectable to any point of transmission line with U10 USB interface*² (field supplied)
- Connection between VRF network system to personal computer is possible via small U10 USB interface. However, both U10 USB interface & personal computer are field supplied items.
- The operating state (Solenoid valve) of RB unit can be checked.

* 1: USB of internet mail system required.

* 2: Web Monitoring Tool (UTY-AMGX) will only support USB type network adaptor and will not support transmission adaptor of the traditional type (UTR-YTMA).

Functions

Web Monitoring System

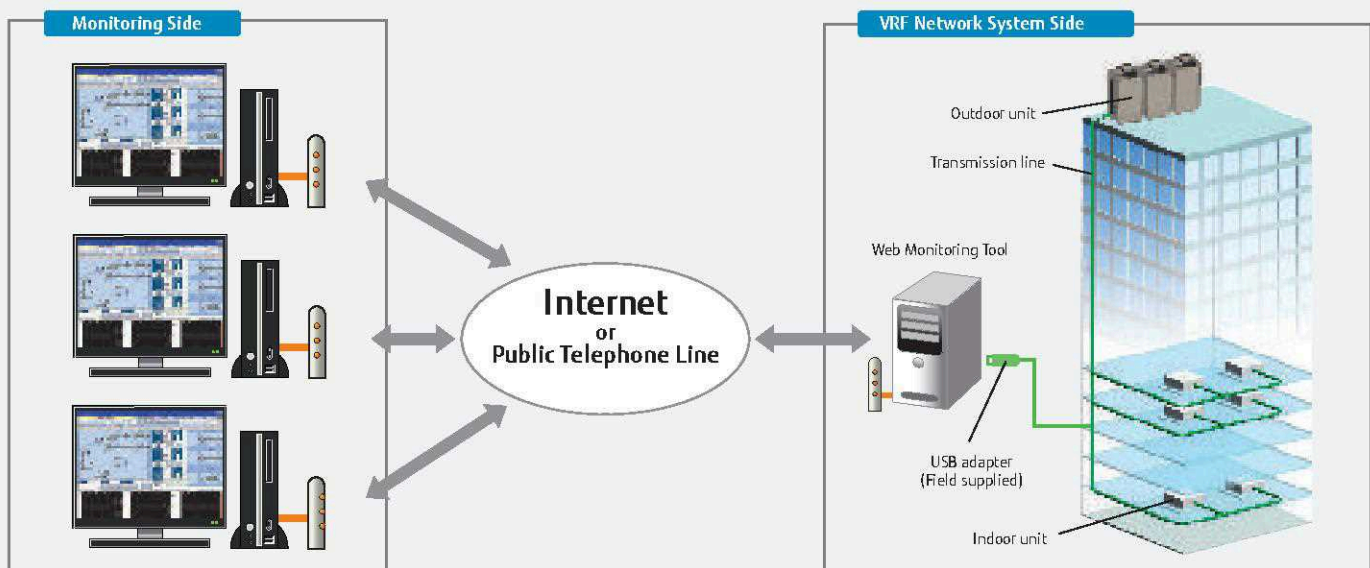

System components

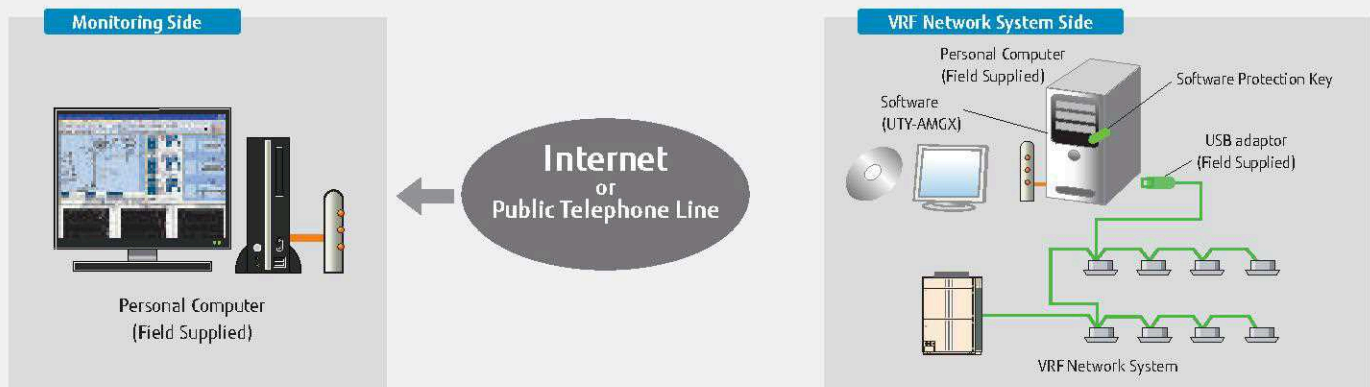

Support 4 VRF network systems

USB adaptor (max. 4 adaptors per PC) permit, monitoring of up to 1,600 indoor units. Suitable for large-scale buildings or hotels.

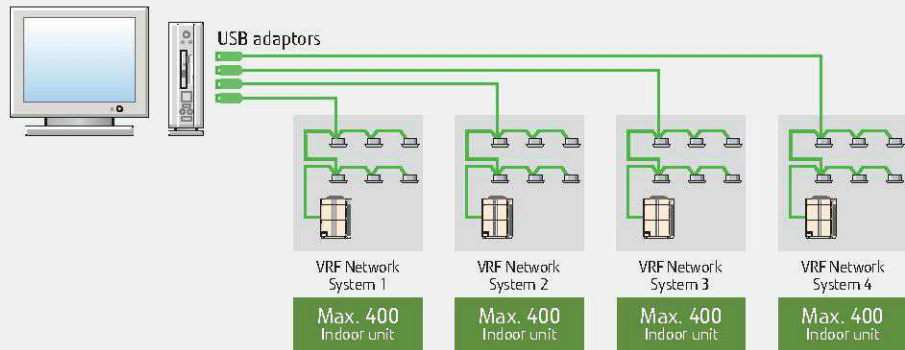

COMPARISON TABLE

No.	Item	Service Tool UTY-ASGX	Web Monitoring Tool UTY-AMGX	
			VRF network system Side	Monitoring Side
1	Interchangeability of equipment	●	●	●
2	Indication of equipment list	●	●	●
3	Operation control	●	●	—
4	Indication of refrigerant circuit diagram	●	●	●
5	Commissioning tool	●	●	—
6	Monitoring of equipment information	●	●	●
7	Monitoring of operating condition	●	●	●
8	Monitoring of sensor data	●	●	●
9	Storage and CSV output of operating history (sensor data)	●	●	●
10	Indication of trend graph	●	●	●
11	Printing of trend graph	●	●	●
12	Monitoring and screen display of abnormalities	●	●	●
13	E-mail automatic transmission of abnormalities	—	●*1	—
14	Setting for user level	—	—	—
15	Network Topology Analyzer *	●	●	—
16	Remote Setting *	●	●	—
17	System Time Setting *	●	●	—
18	Central Release *	●	●	—
19	Model Name Writer *	●	—	—
20	Error Memory Reader *	●	—	—
21	Time Guard Information *	●	●	●

*: Supported by Ver. 1.1 or later

*1: It is available only during a connection to the Internet.

Personal computer system requirements

	UTY-AMGX
Operating system	<ul style="list-style-type: none"> • Microsoft® Windows Vista® Home Premium (32-bit) SP2, Windows Vista® Business (32-bit) SP2 • Microsoft® Windows® 7 Professional (32-bit or 64-bit) SP1 • Microsoft® Windows® 8.1 Pro (32-bit or 64-bit) • Microsoft® Windows® 10 Pro (32-bit or 64-bit)
CPU	1 GHz or higher
Memory	<ul style="list-style-type: none"> • 1 GB or more (for Windows Vista®, Windows® 7 [32-bit], Windows® 8.1 [32-bit], and Windows® 10 [32-bit]) • 2 GB or more (for Windows® 7 [64-bit], Windows® 8.1 [64-bit], and Windows® 10 [64-bit])
HDD	40 GB or more of free space
Display	1024 x 768 or higher resolution
Interface	<ul style="list-style-type: none"> • Ethernet port (for getting access to the Internet using LAN) or Modem (for getting access to the Internet using Public Telephone Line) • USB ports (Maximum of 5 ports) <ul style="list-style-type: none"> - 1 USB port is required for WibuKey connection - Maximum of 4 USB ports are required for Echelon® U10 USB Network Interface * Maximum number of required USB ports depends on the applicable system configurations.
Software	Internet Explorer® 8, 9, 10 or 11 / Adobe® Reader® 9.0 or later
Optical drive	DVD-ROM drive

<Packing list>

Name and shape	Quantity	Application
DVD-ROM	1	Includes the software and manuals
Wibu Key (Software protection key)	1	Software protection key to be connected to USB port on the Service Tool-installed PC. These products runs only on a PC with WibuKey.

• Personal computer that satisfies the following system requirements

• Echelon® U10 USB Network Interface – TP/FT-10 Channel (Model number: 75010R) (Required for each VRF Network.)

Energy Recovery Ventilator

Models

- UTZ-BD025B
- UTZ-BD035B
- UTZ-BD050B
- UTZ-BD080B
- UTZ-BD100B



Feature

Heat exchange ventilation and normal ventilation

Heat exchange ventilation

When a room is cooled or heated, the exhausted cooling / heating energy is recovered by heat-exchange ventilation.

Normal ventilation

The operation is used during periods when the room space requires no cooling or heating effect, i.e. when there is minimal temperature difference between the indoor and outdoor environments.

Adopts a highly efficient counter-flow heat exchange element



Energy efficiency and ecology

Energy consumption is dramatically reduced by using a counterflow heat-exchange element. Air conditioning load is reduced by approximately 20%, resulting in significant energy savings. Recovers up to 77% of the heat in the outgoing air.

20%
Energy saving

Features of heat exchange element

With the cross-flow element, air moves in a straight line across the element. With the counter-flow element, air flows through the element for a longer time (longer distance), so the heat-exchange effect remains unchanged.

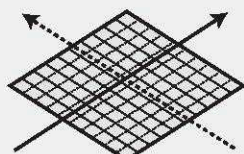

Other element
(Cross-flow element)

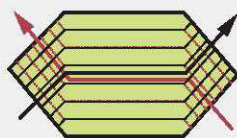

Fujitsu element
(Counter-flow element)

Reverse mountable direct air supply / exhaust system

Adoption of straight air supply / exhaust system: Duct design is simplified because the air supply / exhaust ducts are straight.

Since each unit can be mounted in reverse position, only one inspection hole is needed for two units: Two units can share one inspection hole so duct work is easier and more flexible.

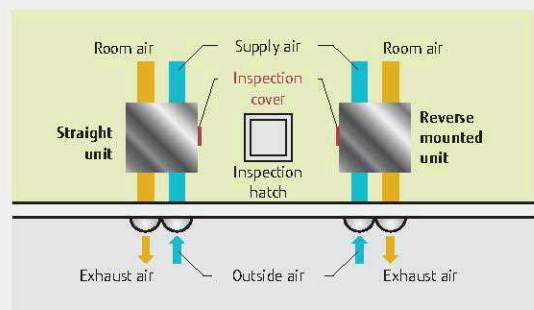

Quiet operation

Significantly reducing low pressure loss and noise allows low-noise operation.

Feature

Slim shape and easier installation

Counter-flow heat exchange element used for reduced noise and slimmer, more compact body shape.

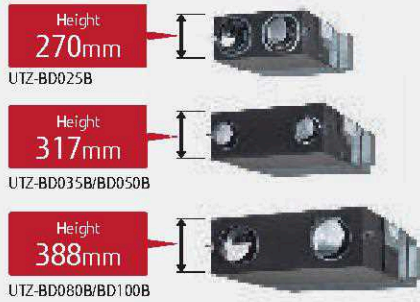

Extended range of an external static pressure

An external static pressure is improved by adopting a powerful fan motor. This allows for application in a wide variety building.

Specifications

			(Tentative)					
Rated flow rate			250 m ³ /h	350 m ³ /h	500 m ³ /h	800 m ³ /h	1000 m ³ /h	
Model No.			UTZ-BD025B	UTZ-BD035B	UTZ-BD050B	UTZ-BD080B	UTZ-BD100B	
Power source			220 - 240V, 50Hz					
HEAT EXCHANGE VENTILATION	Input power	Extra high / High / Low	kW	128 / 123 / 96	190 / 185 / 168	289 / 225 / 185	418 / 378 / 295	464 / 432 / 311
	Air flow rate	Extra high / High / Low	m ³ /h	250 / 250 / 190	350 / 350 / 240	500 / 500 / 440	800 / 800 / 630	1000 / 1000 / 700
	External static pressure	Extra high / High / Low	Pa	105 / 95 / 45	140 / 60 / 45	120 / 60 / 35	140 / 110 / 55	105 / 80 / 75
	Temperature Exchange Efficiency	Extra high / High / Low	%	75 / 75 / 77	75 / 75 / 78	75 / 75 / 76	75 / 75 / 76	75 / 75 / 79
	Energy Exchange Efficiency Cooling	Extra high / High / Low	%	63 / 63 / 65	66 / 66 / 71	62 / 62 / 64	65 / 65 / 68	65 / 65 / 70
	Energy Exchange Efficiency Heat pump	Extra high / High / Low	%	70 / 70 / 72	69 / 69 / 73	67 / 67 / 69	71 / 71 / 74	71 / 71 / 76
	Sound pressure level	Extra high / High / Low	dB*	31.5 / 30.5 / 26.5	33 / 31 / 25.5	37.5 / 35.5 / 32.5	37.5 / 37 / 34.5	38.5 / 37.5 / 34.5
NORMAL VENTILATION	Input power	Extra high / High / Low	W	128 / 123 / 96	190 / 185 / 168	289 / 225 / 185	418 / 378 / 295	464 / 432 / 311
	Air flow rate	Extra high / High / Low	m ³ /h	250 / 250 / 190	350 / 350 / 240	500 / 500 / 440	800 / 800 / 630	1000 / 1000 / 700
	External static pressure	Extra high / High / Low	Pa	105 / 95 / 45	140 / 60 / 45	120 / 60 / 35	140 / 110 / 55	105 / 80 / 75
	Sound pressure level	Extra high / High / Low	dB*	31.5 / 30.5 / 26.5	33 / 31 / 25.5	38.5 / 38 / 32.5	37.5 / 37 / 34.5	40.5 / 39.5 / 36.5
Dimensions (W × D × H)			mm	882 × 599 × 270	1050 × 804 × 317	1090 × 904 × 317	1322 × 884 × 388	1322 × 1134 × 388
Weight			kg	29	49	57	71	83
Outlet duct diameter			mm	150	150	200	250	250
Operation range			°C	-10 ~ 40	-10 ~ 40	-10 ~ 40	-10 ~ 40	-10 ~ 40
Maximum humidity			%	85	85	85	85	85

* The noise level must be measured 1.5 m below the centre of the unit.

Dimensions (Unit : mm)

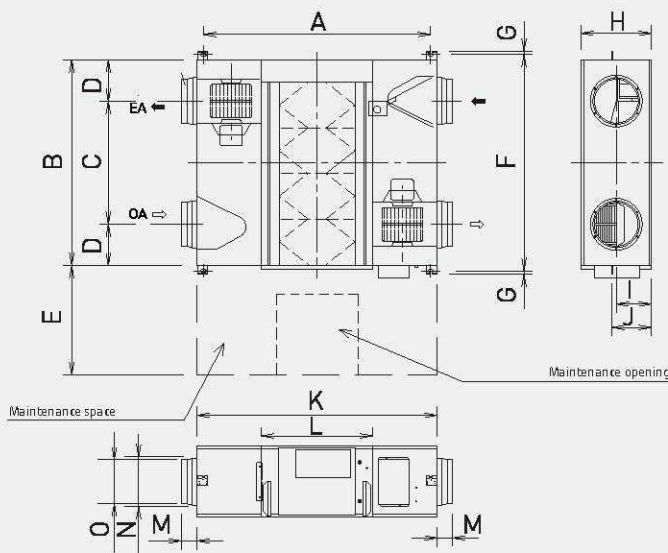

	UTZ-BD025B	UTZ-BD035B	UTZ-BD050B	UTZ-BD080B	UTZ-BD100B
A	810	978	1018	1250	1250
B	599	804	904	884	1134
C	315	580	640	428	678
D	142	112	132	228	228
E	600	600	600	600	600
F	655	860	960	940	1190
G	19	19	19	19	19
H	270	317	317	388	388
I	135	159	159	194	194
J	159	182	182	218	218
K	882	1050	1090	1322	1322
L	414	470	470	612	612
M	95	70	127	85	85
N	219	162	210	258	258
O	144	144	194	242	242

Outdoor Air Unit

Production by order

Models

- ARXH054GTAH
- ARXH072GTAH
- ARXH096GTAH



ARXH054GTAH



ARXH072GTAH



ARXH096GTAH

Feature

One VRF system can provide air conditioning and air supply at the same time.

Outdoor Air Unit can be connected in a same VRF*1 system as one of indoor unit series and can create fresh and comfortable air supply together from our high advanced technology.

*1. Connectable VRF series: J-IIS, J-II, V-II, V-II tropical, VR-II
In J-II series alone, OAU is prohibit to connect under the ambient temperature of 40°C or higher.

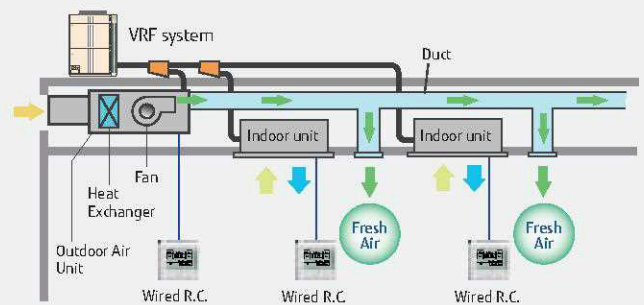
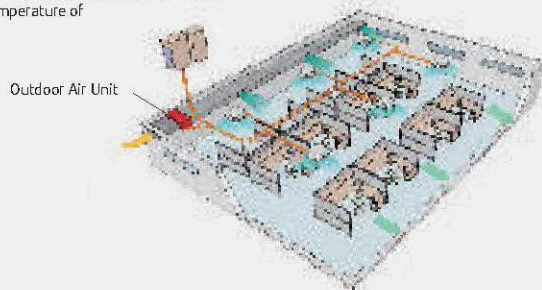

* Make sure the connected capacity is within the range of 50% to 100% of the outdoor unit capacity. In addition, if there are mixed connections with indoor units, make the Outdoor Air Unit connection capacity 30% or less of the outdoor unit capacity.

High energy savings and flexible duct design by using DC motor

- Greatly reduces electricity consumption by adopting permanent magnet compared to when using an AC motor.



- Compared with AC motor, changing the speed makes it possible to respond flexibly to the external static pressure from 50 Pa to 240 Pa. Even if damper equipment is not used, static pressure can be adjusted and duct design is easy.
- Static pressure can be set easily using wired remote controller.

Top class compact design

- Top class lightweight compact design at just 425 mm in height, 55 kg in weight for ARXH072 type. This unit can be installed easily even at narrow space.

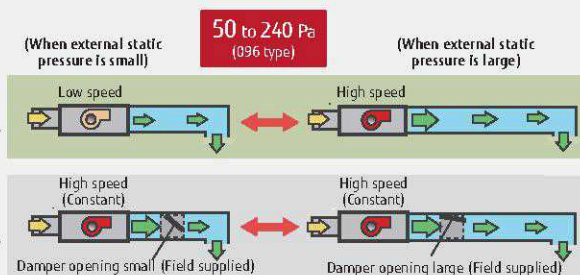

Feature

Various Controller

Supplied variety of controllers as options, such as individual controller, central controller, and building management controller.

Individual Controller

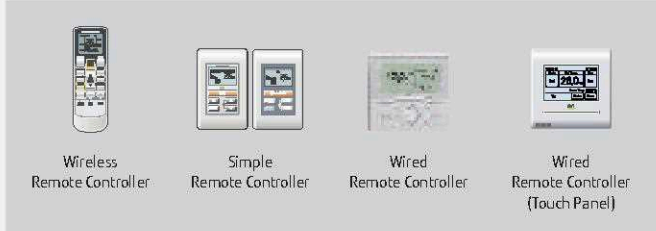

Central Controller



* The temperature setting is discharged air temperature setting. The air volume is set to a constant speed.

Specifications

(Tentative)

Rated flow rate			1000 m ³ /h	1500 m ³ /h	2000 m ³ /h
Model No.			ARXH054GTAH	ARXH072GTAH	ARXH096GTAH
Power source			230/1/50	230/1/50	230/1/50
Capacity	Cooling	kW	14.0	22.4	28.0
	Heating		8.9	13.9	17.4
Input Power	Cooling / Heating	W	179	292	370
Airflow Rate		m ³ /h	1,080	1,680	2,100
Static Pressure	Standard (range)	Pa	185 (50-185)	200 (50-200)	200 (50-240)
	Sound Pressure Level	dB(A)	42	44	47
Dimensions (H x W x D)		mm	425×1,367×572	425×1,367×572	450×1,583×700
Weight		kg	48	55	71
Connection Pipe Diameter (Small / Large)		mm	Ø9.52/Ø19.05	Ø12.70/Ø22.22	Ø12.70/Ø22.22
Operation Range	Cooling	°CDB	5 to 43	5 to 43	5 to 43
	Heating		-7 to 21	-7 to 21	-7 to 21
Refrigerant			R410A	R410A	R410A

Note : Specifications are based on the following conditions.

Cooling : Outdoor temperature of 33°CDB / 28°CWB.
 Heating : Outdoor temperature of 0°CDB / -2.9°CWB.
 Pipe length : 7.5 m Voltage : 230 [V].

Dimensions (Unit : mm)

ARXH054GTAH

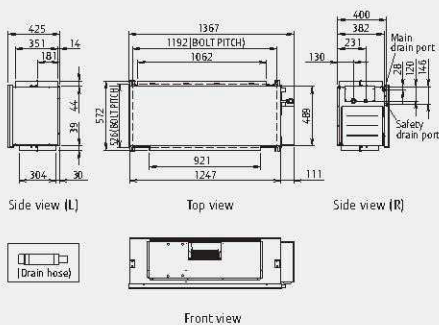

ARXH072GTAH

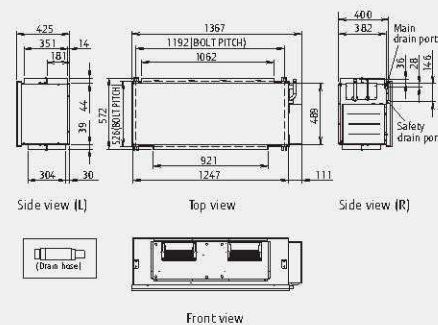

ARXH096GTAH

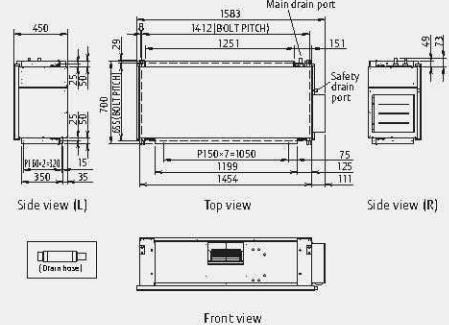

Auto Louver Grille Kit (Option)

Models

- UTD-GXTA-W
- UTD-GXTB-W
- UTD-GXTC-W

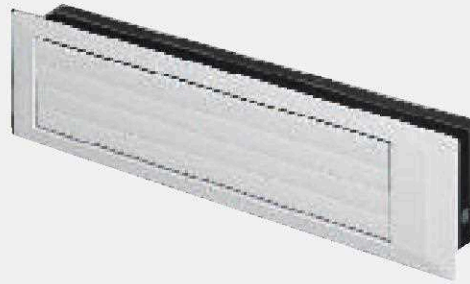

Feature

Flexible Control

- **Operation with indoor unit**
Auto Louver can be operated by synchronizing remote controller of indoor unit.
- **UP and Down auto swing**
 - Auto airflow direction and auto swing
 - 4 steps selectable
- **Auto-closing louver**
When operation of indoor unit is stopped, the louver will automatically close.

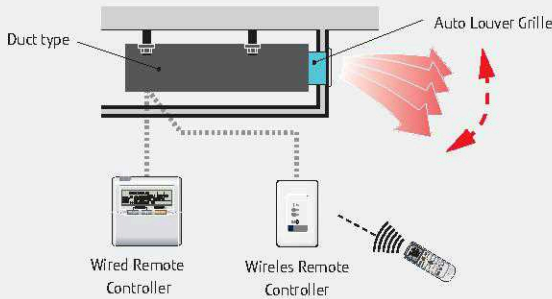

Dimensions

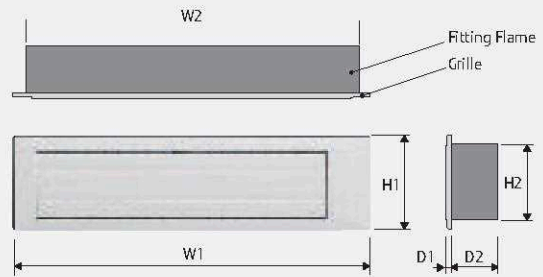

Model Name	W1	W2	H1	H2	D1	D2
UTD-GXTA-W	683	645	180	148	9	84
UTD-GXTB-W	883	845				
UTD-GXTC-W	1,083	1,045				

Unit: mm

Specifications

Model name	UTD-GXTA-W		UTD-GXTB-W		UTD-GXTC-W	
Applicable Indoor Unit	ARXD07/09/12/14GALH ARXD07/09/12/14GATH ARXD07/09/12/14LATH ARXK07/09/12/14GCLH ARXK07/09/12/14GALH		ARXD18GALH ARXD18GATH ARXD18LATH ARXK18GCLH ARXK18GALH		ARXD24GALH ARXD24GATH ARXD24LATH ARXK24GCLH ARXK24GALH	
Power source	Connecting with Control box of indoor unit					
Fixing of Auto Louver Grille	Screw fixing to Flange or Square Duct					
Extension Square Duct Limit	1.0m (Max. duct length between indoor unit and Grille)					
Net Dimension (H x W x D)	mm (inch)	180x683x(84+9) [7-3/32 x 26-7/8 x (3-5/16+11/32)]	180 x 883 x (84+9) [7-3/32 x 34-3/4 x (3-5/16+11/32)]	180 x 1083 x (84+9) [7-3/32 x 42-5/8 x (3-5/16+11/32)]		
Weight	Net	kg (lb.)	2.0 (4.4)	2.5 (5.6)	3.0 (6.7)	
	Gross	kg (lb.)	3.0 (6.7)	3.5 (7.8)	4.0 (8.9)	
Color	White					
Louver Motor	Stepping Motor					
Accessories	Fitting Flange, etc.					
Operation Range	Cooling	°C (°F)	18 to 32 (64 to 90)			
		% RH	80% or less			
	Heating	°C (°F)	16 to 30 (60 to 88)			

*: The Auto Louver Grille Kit can also be installed to ARXD07/09/12/14/18/24LATH revision code B models. Please refer to the Design & Technical manual for "revision code" details.

Optional Parts

Connection Units

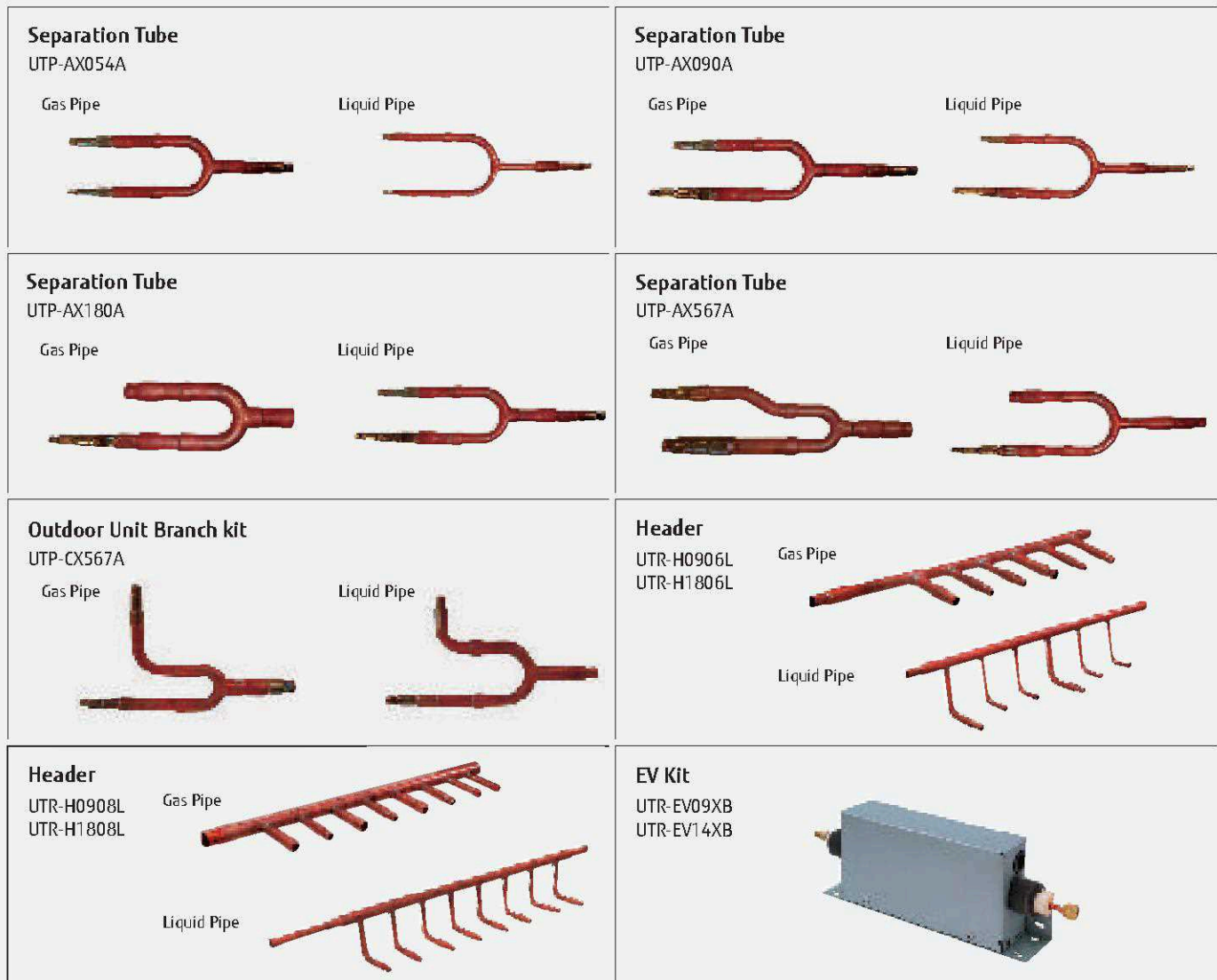

Specifications

Outdoor unit Branch kit		UTP-CX567A	
Model name		UTP-CX567A	
Number of Outdoor unit	2 outdoor units	1	
	3 outdoor units	2	

Separation Tube				
Model name	UTP-AX054A	UTP-AX090A	UTP-AX180A	UTP-AX567A
Total cooling capacity of indoor unit (kW)	19.6 or less	28.0 or less	28.1 to 56.0	56.1 or more

Header			
Model name	3-6 Branches	UTR-H0906L	UTR-H1806L
	3-8 Branches	UTR-H0908L	UTR-H1808L
Total cooling capacity of indoor unit (kW)	28.0 or less		28.1 to 56.0

EV Kit			
Model name	UTR-EV09XB	UTR-EV14XB	
Application Model	ASHE07GACH	ASHE12GACH	
	ASHE09GACH	ASHE14GACH	



Optional Parts

Controllers

For Individual Control

<p>Wired Remote Controller (Touch Panel) UTY-RNRGZ1</p> 	<p>Wired Remote Controller UTY-RLRG</p> 	<p>Simple Remote Controller UTY-RSKG With operation mode</p> 
<p>Simple Remote Controller UTY-RHKG Without operation mode</p> 	<p>Wireless Remote Controller UTY-LNHG</p> 	<p>IR Receiver Unit UTB-YWC For All Duct types except Large Airflow Duct</p> 
<p>IR Receiver Unit UTY-LRHGB1 For Cassette type</p> 		

For Centralized Control

<p>Group Remote Controller UTY-CGGG</p> 	<p>Central Remote Controller UTY-DCCG</p> 	<p>Touch Panel Controller UTY-DTGGZ1 NEW</p> 
<p>System Controller Lite Software UTY-ALGX</p> 	<p>System Controller Software UTY-APGX</p> 	

Convertors / Adaptors

For External device

<p>BACnet® Gateway Software UTY-ABGX</p> <div style="display: flex; justify-content: space-around; align-items: center;">   </div> <p>DVD-ROM (Software) Software Protection Key</p>	<p>Network Converter for LonWorks® UTY-VLGX</p> 	<p>External Switch Controller UTY-TEKX</p> 
--	---	---

For System expansion

<p>Network Converter UTY-VGGXZ1</p> 	<p>Signal Amplifier UTY-VSGXZ1</p> 	<p>Network Converter UTY-VTGX NEW DC power supply type</p> 
<p>Network Converter UTY-VTGXV NEW AC power supply type</p> 	<p>MODBUS® Converter for VRF UTY-VMGX NEW</p> 	

Panels











For Cassette type

<p>Cassette Grille UTG-UFGC-W For Compact Cassette type</p> 	<p>Cassette Grille UTG-UGGA-W For Cassette type</p> 	
--	---	--

Optional Parts

Others

Communication system: External Connect Kit

For Indoor unit UTY-XWZXZ7  UTY-XWZXZB  UTY-XWZXZC 		For Outdoor unit UTY-XWZXZ6  UTY-XWZXZ9  UTY-XWZXZF 	
For Central Remote Controller UTY-XWZXZ7  UTY-XWZXZB  UTY-XWZXZA 		For Touch Panel Controller UTY-XWZXZA 	

Function list

		Indoor unit	Outdoor unit	Controller	
				Central Remote Controller	Touch Panel Controller
Input	Operation / Stop	● UTY-XWZXZD ○ UTY-XWZXZB	—	—	—
	All On / All Off	—	—	● UTY-XWZXZ7 ○ UTY-XWZXZ8	● *3 ○ *3
	Batch Stop	—	● UTY-XWZXZ6	—	—
	Forced Stop	● UTY-XWZXZD ○ UTY-XWZXZB	—	—	—
	Emergency Stop	● UTY-XWZXZD ○ UTY-XWZXZB	● UTY-XWZXZ6	● UTY-XWZXZ7 ○ UTY-XWZXZ8	● *3 ○ *3
	Forced Thermostat off	● UTY-XWZXZE ○ UTY-XWZXZ7	—	—	—
	Low Noise Mode Operation	—	● UTY-XWZXZ6	—	—
	Cooling / Heating Priority	—	● UTY-XWZXZ6*1	—	—
	"Outdoor Unit Operation Peak Control"	—	● UTY-XWZXZ6	—	—
	"Power Usage Information from Electricity Meter"	—	● UTY-XWZXZF	—	● *3 ○ *3
Output	Operation Status	● UTY-XWZXZC	○ UTY-XWZXZ6	○ UTY-XWZXZA	○ UTY-XWZXZA
	Error Status	● UTY-XWZXZC	○ UTY-XWZXZ6	○ UTY-XWZXZA	○ UTY-XWZXZA
	Indoor Unit Fun Operation Status	● UTY-XWZXZC	—	—	—
	Auxiliary Heater Output	● UTY-XWZXZC*2	—	—	—
	Base Heater	—	● UTY-XWZXZ9	—	—

*1. Heat Pump type only

*2. Duct type only



*3. Touch Panel Controller has these functions for Dry contact and Apply voltage, however, above External Connect Kit is not necessary because Touch Panel Controller has an external input terminal block.

● : Dry Contact ○ : Apply Voltage

For Duct type

<p>Flange (Round) UTD-RF204 For Medium Static Pressure Duct type / Ceiling type</p> 	<p>Flange (Square) UTD-SF045T For Medium Static Pressure Duct type</p> 	<p>Remote Sensor Unit UTY-XSZX For All Duct type</p> <p>New amenity space can be offered by installing the Remote sensor.</p> 
<p>Long-Life Filter UTD-LF25NA For Medium Static Pressure Duct type</p>  <p>UTD-LF60KA For High Static Pressure Duct type</p> 	<p>Auto Louver Grille Kit UTD-GXTA-W (for ARXD07/09/12/14, ARXK07/09/12/14) UTD-GXTB-W (for ARXD18, ARXK18) UTD-GXTC-W (for ARXD24, ARXK24) For Slim Duct type / Mini Duct type</p> 	<p>Drain Pump Unit UTZ-PX1BBA For Low Static Pressure Duct type</p> <p>UTZ-PX1NBA For Medium Static Pressure Duct type</p> 

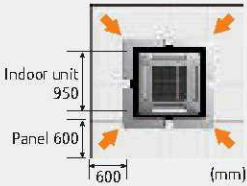
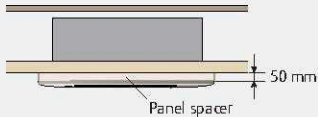
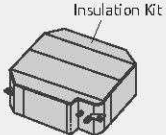
For Cassette type

<p>Wide Panel UTG-AKXA-W For Cassette type</p>  <p>Indoor unit 950 Panel 600 600 (mm)</p>	<p>Panel Spacer UTG-BKXA-W For Cassette type</p>  <p>50 mm Panel spacer</p>	<p>Insulation Kit for High Humidity UTZ-KXRA For Cassette type UTZ-KXGC For Compact Cassette type</p>  <p>Insulation Kit</p>
<p>Air Outlet Shutter Plate UTR-YDZB For Compact Cassette type</p> <p>Shuts the air outlet when only using as 3 blow out.</p> 	<p>Air Outlet Shutter Plate UTR-YDZK For Cassette type</p> <p>Shuts the air outlet when only using as 3 blow out.</p> 	

For Ceiling type

<p>Drain Pump Unit UTR-DPB24T For Ceiling type</p> 		
---	--	--

Applications

There are many applications for Airstage VRF systems including such markets as education, healthcare, hospitality, utilities, office buildings, apartment buildings, condominiums, and restaurants.

Medical and Healthcare Facilities

VRF gives each patient individual control of their room temperature. Central control ensures that air conditioning is only delivered to rooms that are occupied.

INDIVIDUAL CONTROL

VRF gives each patient or each room individual control of their room temperature.

MAINTENANCE

Since each refrigerant circuit has the ability to operate independently, a properly designed VRF system can add a layer of security to a HVAC system. If an individual unit needs to be shut down for repairs, the rest of the system can operate normally.



CENTRAL CONTROL

Powerful central control ensures that heating and cooling are delivered to rooms that are occupied. This provides enormous savings for facilities with revolving occupancy.

CLEAN AIR

VRF systems can use ductless indoor units reducing the time and expense of maintaining a HVAC system and eliminating the risk of duct-borne molds and bacteria.

FRESH AIR

VRF systems can be integrated with fresh air systems to ensure that air quality meets the needs of the occupants. VRF provides the most comfortable environment for all occupants.

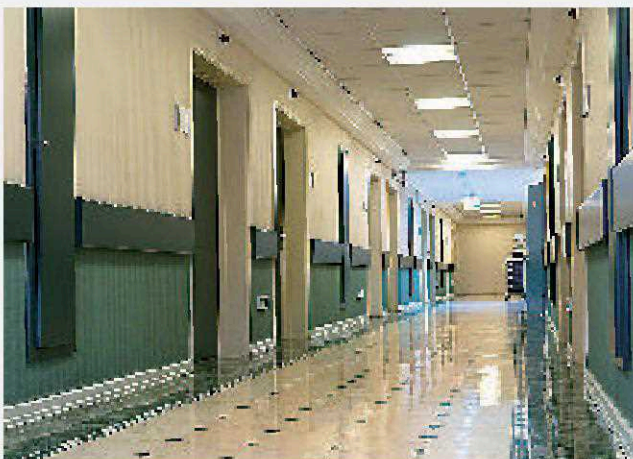

Applications

Educational and Religious Facilities

In a school, an investment in VRF is an investment in your community. VRF is more efficient than conventional systems, providing financial savings to the school for many years. Also, a quiet VRF system creates a much better learning environment for students.

HEALTHIER FACILITY

VRF systems can be integrated with fresh air systems to ensure that air quality meets the needs of the teachers and students.

CENTRAL CONTROL

Powerful central control can monitor and control individual schools, or an entire college campus, from a single location.

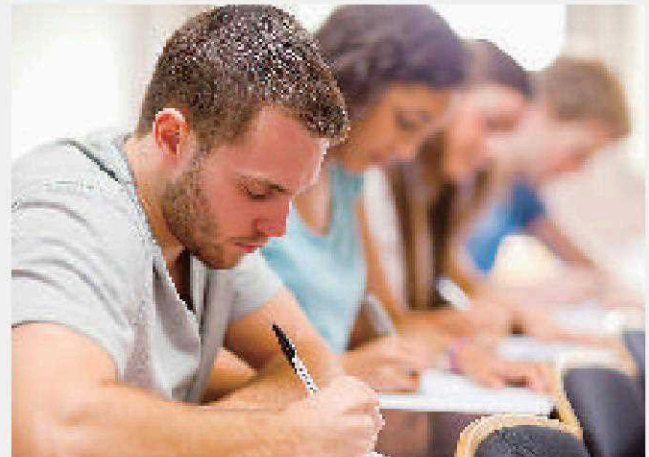

ZONING

Save energy by heating and cooling the classrooms that are occupied. Set temperature can pre-programmed to meet the energy budget for the school district.

COMFORT

VRF helps achieve a healthier, quieter, more comfortable and productive learning environment.

Office Buildings and Retail Spaces

VRF provides a comfortable work environment for all employees. Zoning ensures that energy is only used to cool/heat occupied offices. Quiet indoor units and precise temperature control creates the most comfortable and productive work environment.

QUIET

Indoor units and outdoor units creates a pleasant work environment and reduces noise complaints.

ZONING

Save energy by heating and cooling occupied offices. No more hot/cold calls since each zone or tenant has individual control of the set temperature.

CONTROL

Powerful controls options can manage and monitor entire building from a single location.



EASE OF INSTALLATION

Can be installed in occupied office spaces with minimal disruption to occupants. Can even be installed without disrupting the existing HVAC system.

FLEXIBLE

As tenants and office configurations change, VRF system configurations can also be modified (within original design constraints) to meet the needs of new tenants.

COMFORT

VRF provides a comfortable work environment for all employees. Quiet indoor units and precise temperature control creates the most comfortable and productive work environment.



استان مازندران - آمل
خیابان امام خمینی (ره) - نبش آفتاب ۲۷ - پلاک ۶۱
دپارتمان مارکتینگ: ۰۹۱۱۴۶۰۶۱۶۹
مدیریت فروش: ۰۹۱۱۳۱۰۳۸۲۸
www.asgharianco.com
sales@asgharianco.com
marketing@asgharianco.com

OG-L007 95-6

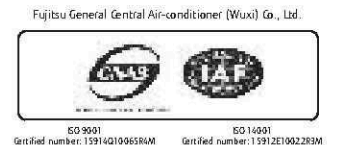

The products or equipments in this catalogue contain fluorinated greenhouse gases.

"**AIRSTAGE**" is a worldwide trademark of FUJITSU GENERAL LIMITED and is a registered trademark in Japan and other countries or areas. Other company and product names mentioned herein may be registered trademarks, trademarks or trade names of their respective owners.

The colors may be different from the actual colors because this catalog is printed matter.
Product specifications are subject to change without notice.

Distributed by:

FUJITSU GENERAL LIMITED

3-3-17, Suenaga, Takatsu-ku, Kawasaki 213-8502, Japan

<http://www.fujitsu-general.com/>

Copyright© 2016 Fujitsu General Limited. All rights reserved.
6MGV31-1601E