



# AIRSTAGE™ V-II

Variable Refrigerant Flow System



**ASGHARIAN**  
**HOLDING**

## *Multi Air Conditioning System for Buildings*

Large Capacity Multi VRF System  
DC Inverter Control Compressor  
Long Piping System Design  
High Efficiency Refrigerant R410A



FUJITSU GENERAL LIMITED



**INVERTER**

# AIRSTAGE™ V-II

Variable Refrigerant Flow System



**ASGHARIAN  
HOLDING**

8, 10, 12HP



DIMENSIONS: H 1,690 X W 930 X D 765 (mm)

## Newly designed compact outdoor unit

Smart and cutting edge design

Extensive lineup from 8HP to 48HP in 2HP increment

Connectable indoor unit capacity ratio up to 150%

### High Efficiency Operating System

EER/COP has been significantly improved by unique inverter technology and refrigerant control technology.



### Installation Flexibility

Total pipe length of 1,000m and 150m **actual** pipe length. From small to large buildings, **any** application can be supported.

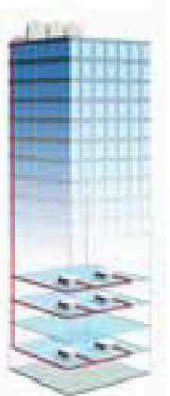

14, 16HP



DIMENSIONS: H 1,690 X W 1,240 X D 765 (mm)

## CONTENTS

### V-II Series Features

High Efficiency Operation .....	4
Design Versatility .....	6
High Reliability .....	8
Easy Installation .....	10
Comfort and Convenience .....	12
Easy Service & Maintenance .....	14

### Outdoor Units

Lineup .....	16
Innovative Technology .....	18
Specifications .....	20
Dimensions .....	22

### Indoor Units

Lineup .....	24
Compact Cassette .....	26
Cassette .....	28
Compact Duct .....	30
Low Static Pressure Duct .....	32
Duct .....	32
High Static Pressure Duct .....	34
Floor / Ceiling .....	36
Ceiling .....	38
Compact Wall Mounted .....	40
Wall Mounted .....	42

### Controller

Control System .....	44
Wiring System .....	46
Comparison with Controllers .....	47
Wired Remote Controller .....	48
Simple Remote Controller .....	49
Wireless Remote Controller .....	50
IR Receiver Unit .....	51
IR Receiver Kit .....	51
Group Remote Controller .....	52
Touch Panel Controller .....	54
System Controller (Software) .....	56

### Convertor & Adaptor

Network Convertor .....	58
Network Convertor for LONWORKS® .....	59
BACnet® Gateway (Software) .....	60
Signal Amplifier .....	61
External Switch Controller .....	61

### Service & Monitoring

Service Tool (Software) .....	62
Web Monitoring Tool (Software) .....	64

### Optional Parts .....

## Compact Design

The outdoor unit size has been significantly reduced by optimizing of equipment. This allows for a reduction in the required installation area floor space.



## User Friendly Central Control

Diverse building air conditioning control functions can be controlled easily by central Airconditioning control.



# High Efficiency Operation

Advanced system considers high efficiency operation

## High Efficiency

### Significantly improved EER/COP

Significantly greater efficiency is realized by the use of a DC twin rotary compressor, inverter technology, and large heat exchanger.

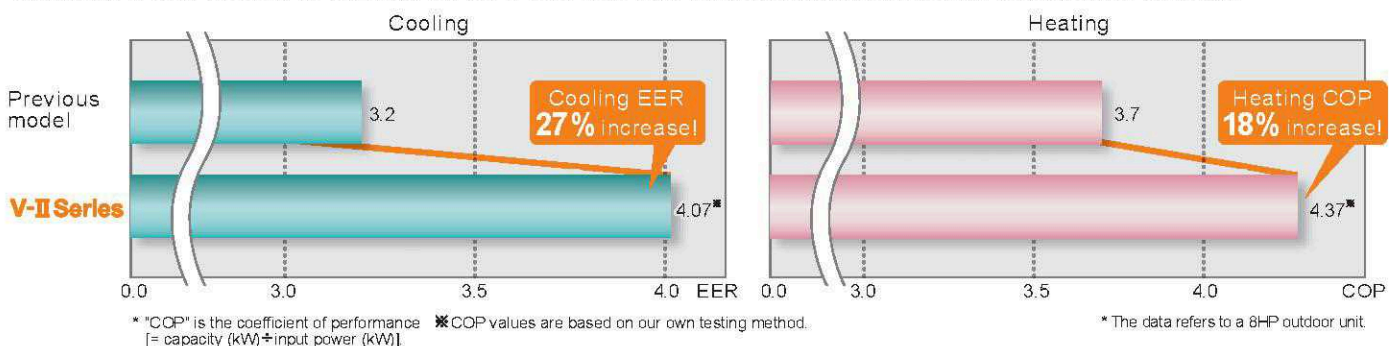

### Energy saving technology that boosted operation efficiency

The central image is a cutaway view of an outdoor unit. It features several callout boxes with images and text:

- DC Fan Motor:** An image of a motor with the text: "Power consumption has been reduced by 25% compared to previous models by using a compact and high performance DC fan motor."
- Sine Wave DC Inverter Control:** An image of a green PCB with the text: "High efficiency operation is realized by using a sine wave DC inverter control."
- DC Twin Rotary Compressor:** An image of a compressor with the text: "Significantly greater efficiency is realized by use of a large capacity DC twin rotary compressor with substantially increased refrigerant intake and compression efficiency."
- 4-face Heat Exchanger:** An image comparing a flat heat exchanger (Previous model) with a curved 4-face heat exchanger (V-II Series). The text says: "Heat exchange efficiency is significantly improved by the introduction of a new 4-face heat exchanger that increases effective surface area." An orange box below indicates "Surface area 1.7 times!".
- Front Intake Design:** An image showing three fans with arrows pointing up into their front intake slots. The text says: "In multiple outdoor unit installations, the unique front intake design improves airflow into the Heat Exchanger."



## Energy efficiency combination

### Choice of space saving or energy efficiency combinations

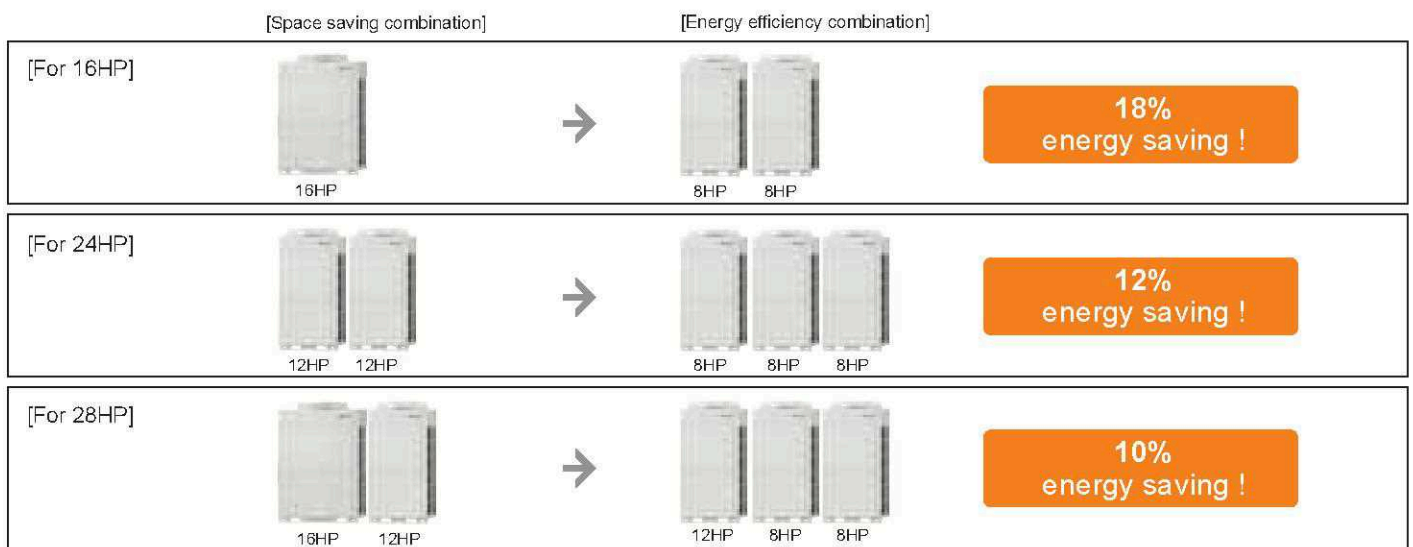

(Comparison of Average COP)

## Various energy saving features

### Economy operation

Economy operation can be set by remote controller.  
The temperature setting is offset automatically over a certain period of time.

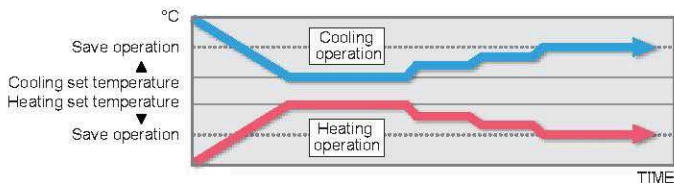

### Room temperature set point limitation

The minimum and maximum temperature range can be set giving further energy saving while considering the comfort of the occupants.

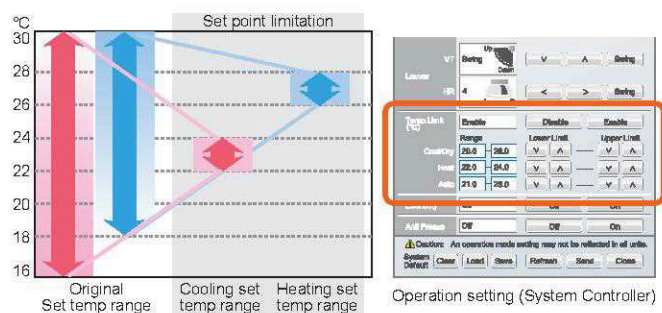

### Capacity shift operation

When the heat load is minimal, capacity can be reduced according to surrounding conditions.

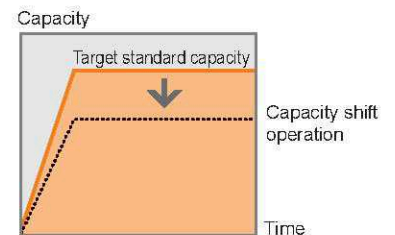

### Auto-off timer

Each remote controller is equipped with an OFF timer function that automatically stops operation when a fixed time has elapsed from the start of operation. This prevents wasteful operation. (NB Except simple remote controller)

# Design Versatility

V-II systems can be applied to a wide variety of Building applications due to the reduced outdoor unit size and piping length capabilities

## Flexible and easy piping design

### Overall piping length 1,000m

World's top class overall piping length of 1,000m allows for application in a wide variety buildings.

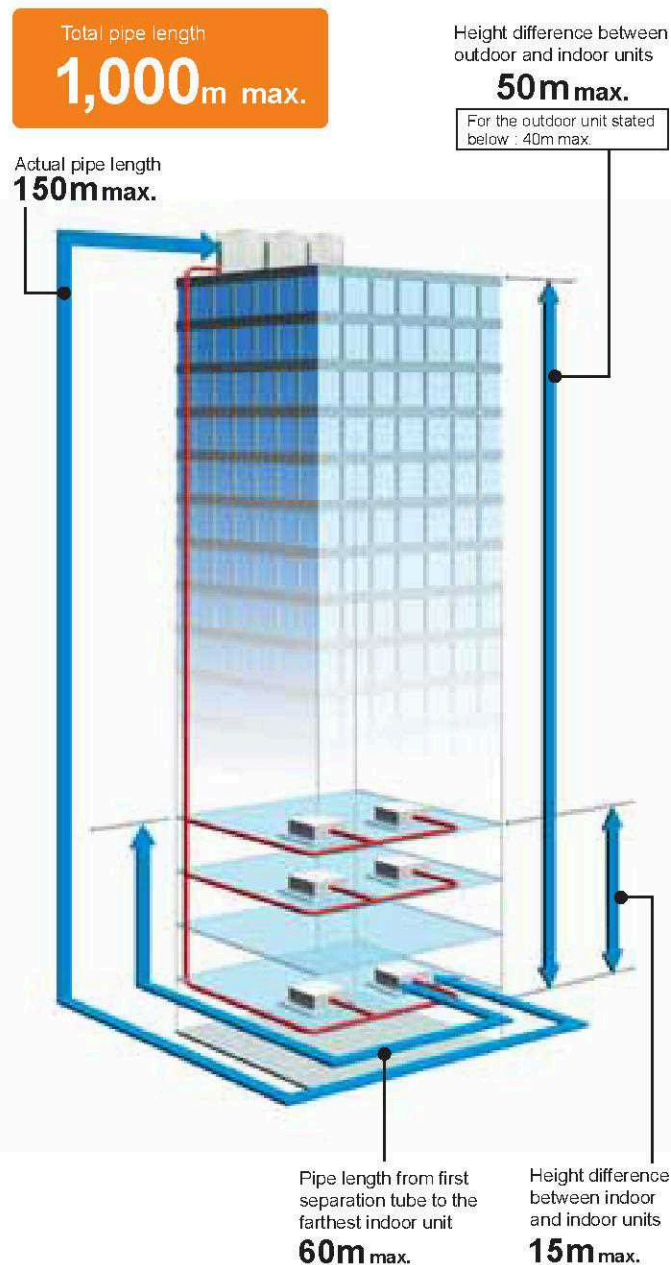

### High static pressure of 80Pa

The outdoor unit can have a condenser hood easily connected with a static pressure of 80Pa standard. This allows outdoor units to be installed within plant rooms in high rise buildings.

Powerful discharge with an external static pressure of 80Pa.

Previous model



V-II Series



Large diameter fan and DC motor has been utilized allowing an external static pressure of 80Pa. This is approximately 2.6 times greater than the previous model.

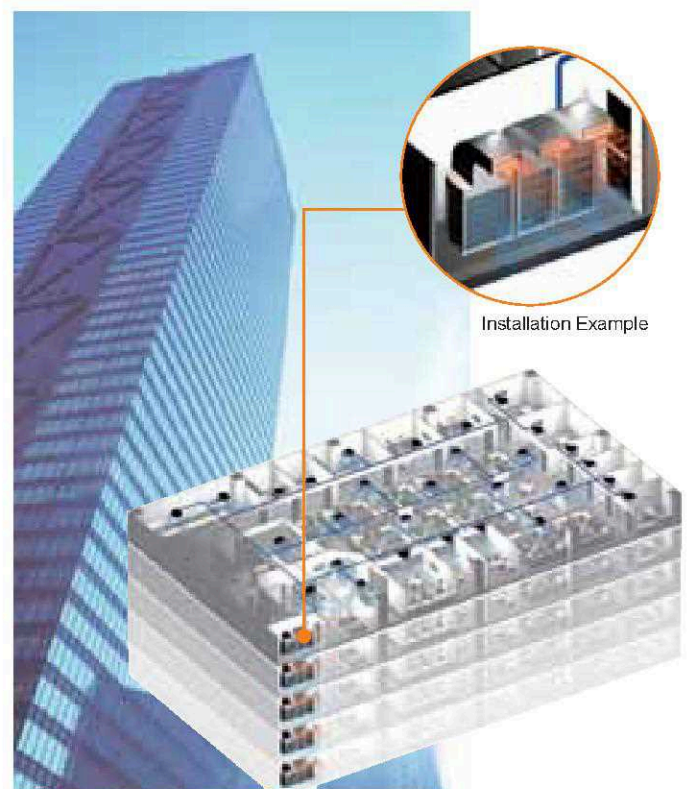

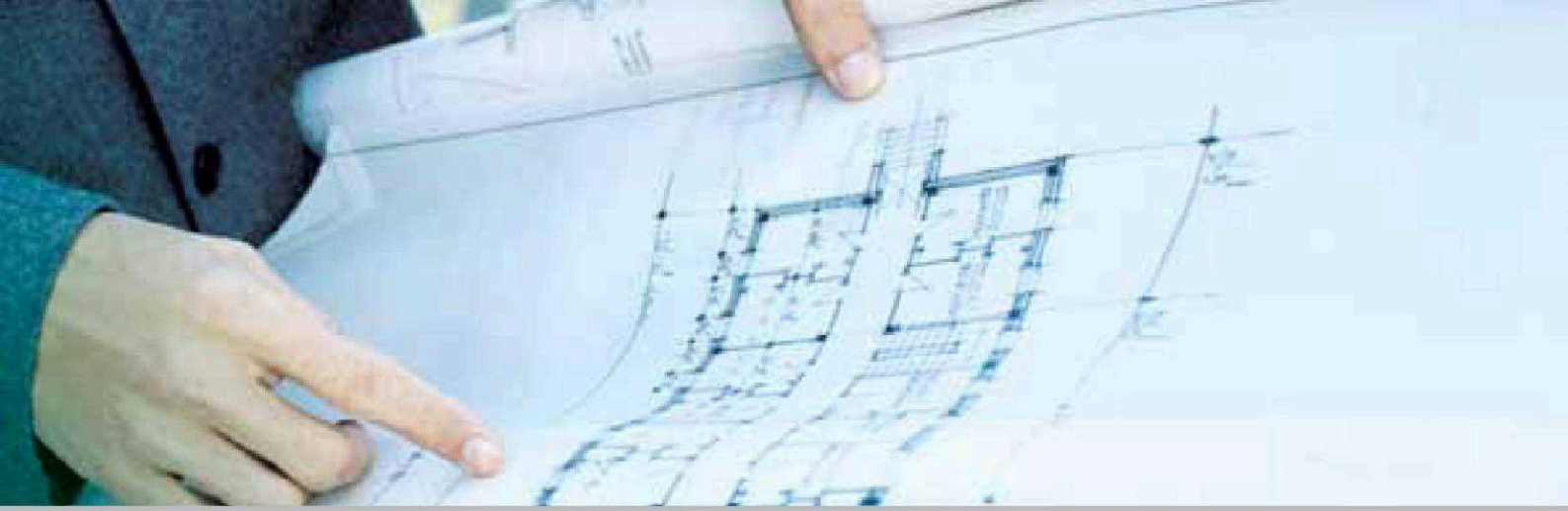

## Space saving and compact size

Compact size has been achieved by significantly reducing the width of the outdoor units compared to previous models.

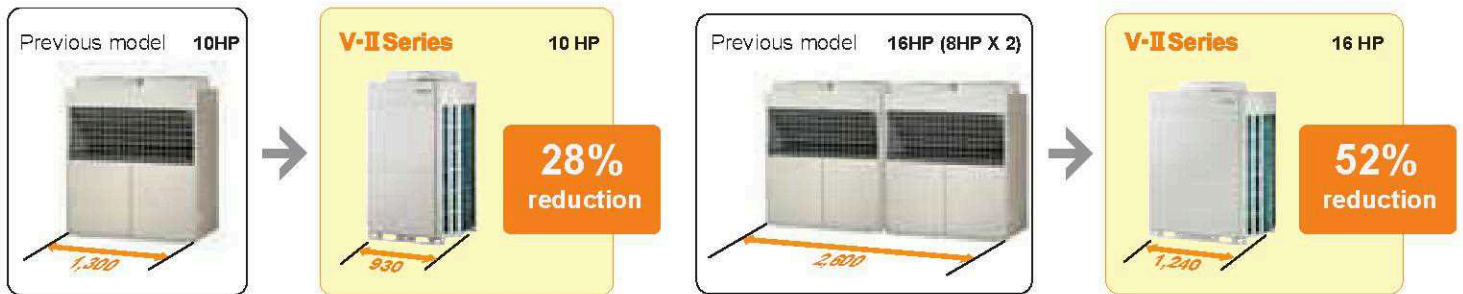

For 160HP

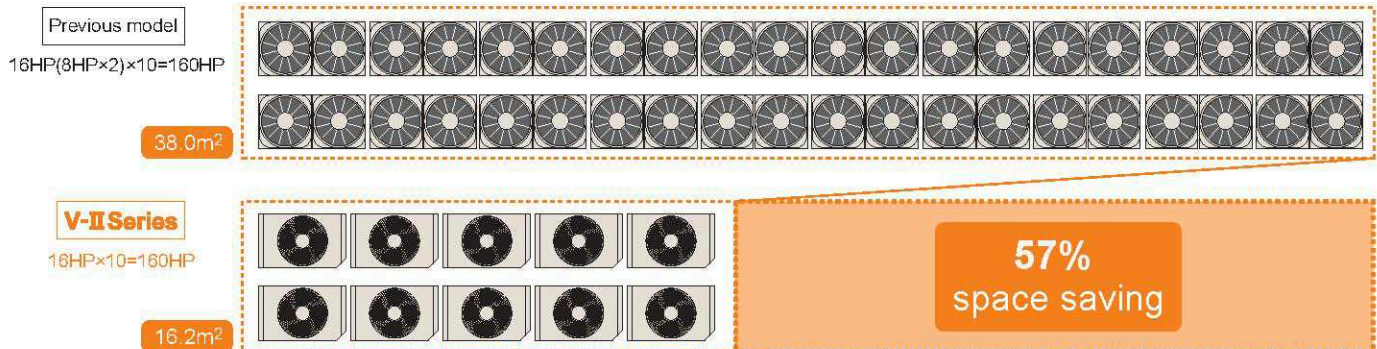

## Wide operating range

Installation in extreme temperature conditions is possible due to an increase in operational range.

Cooling : -15°C~46°C

Heating : -20°C~21°C

(°C)

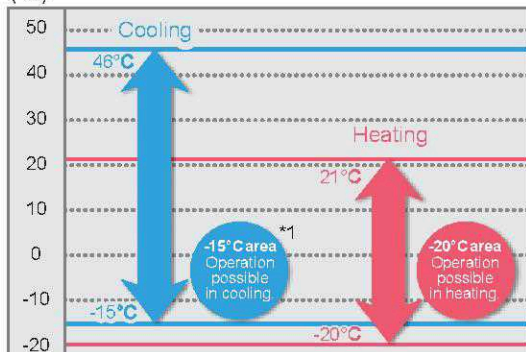

\*1 Note : When a multiple outdoor unit connection is used, operating range is from -5°C to 46°C in cooling.

## Various combinations

Various combination from 8HP to 48HP with 2HP increments. 11 types, 49 models of indoor units can be selected ranging from 2.2kW to 25kW in capacity. A maximum of 150% indoor unit connectable capacity.

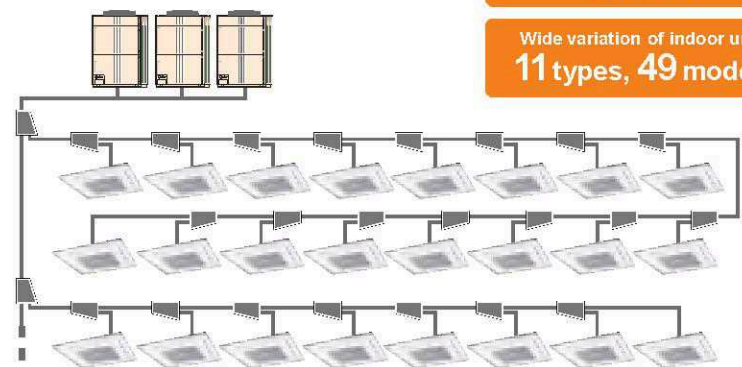

Note : when indoor unit connected capacity is greater than 100%, individual indoor units will operate at a slightly lower capacity when maximum capacity is required.

Connectable indoor unit capacity

Ratio up to 150%

Connectable indoor unit number

up to 48

Wide variation of indoor units

11 types, 49 models

# High Reliability

High reliability considering long-term safety and confidence

## Longer lasting units

### Outdoor unit operation rotation

The compressor starting order is rotated so that the running time is shared.

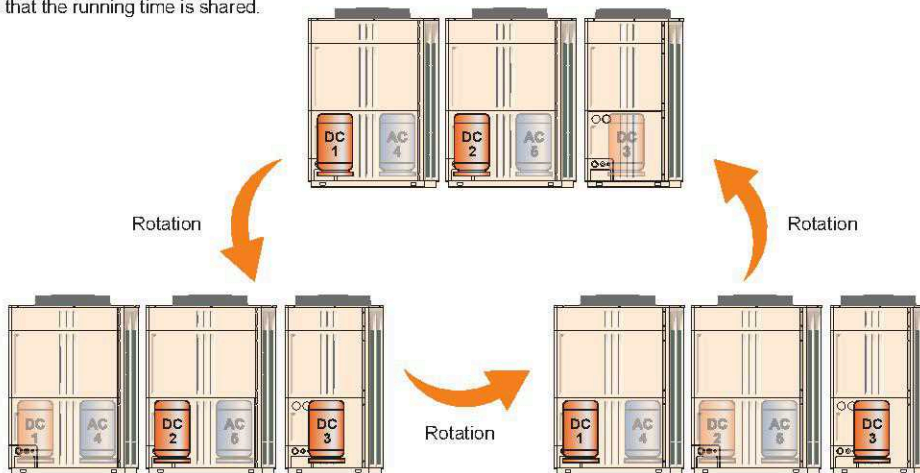

Note : The inverter compressors start in priority.  
Rotate operation is alternated by the start / stop timing of the compressors

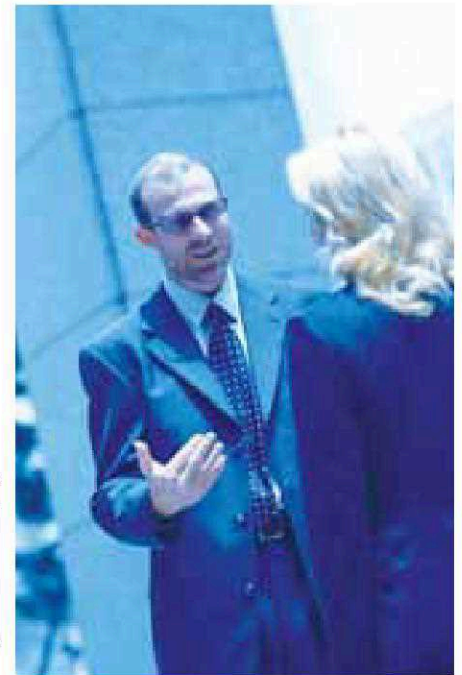

## Continuous operation

### Backup operation

If one compressor malfunctions, it will not affect the operation of the remaining outdoor units.

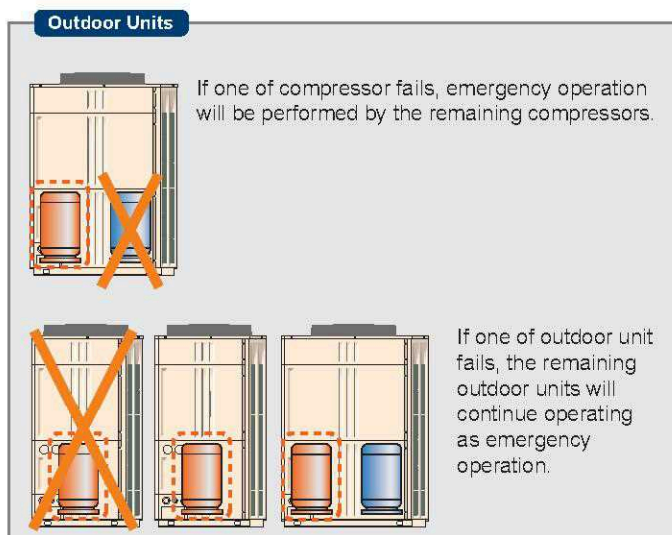

### Indoor Units

#### Indoor unit continuous operation

Each indoor unit is controlled individually on the system network. This allows all indoor units to continue to operate unaffected even if an error should occur at any indoor unit's on the VRF system.

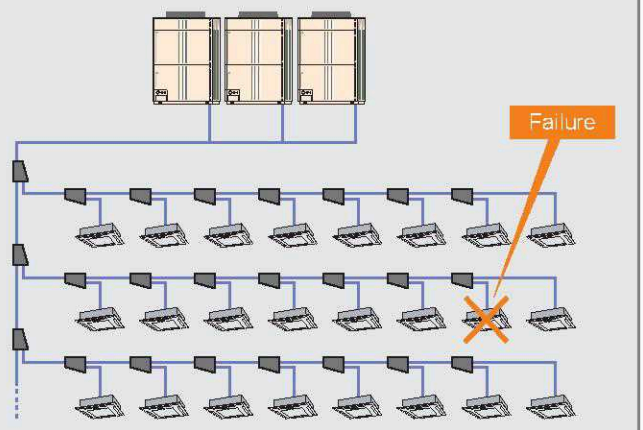



## Corrosion treatment

### ■ Adoption of blue fin heat exchanger

Corrosion resistant of the heat exchanger has been improved by the introduction of blue fin treatment to the outdoor unit's heat exchanger.

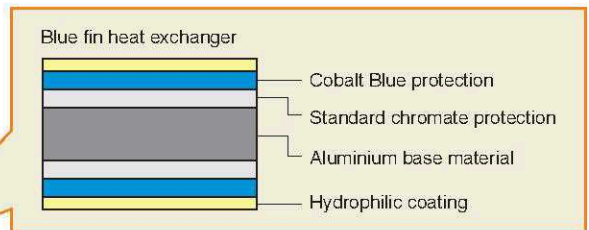

## Remote monitoring

### ■ Remote monitoring over the internet

The Web Monitoring system allows you view system operation at all times over the internet ensuring trouble free operation.

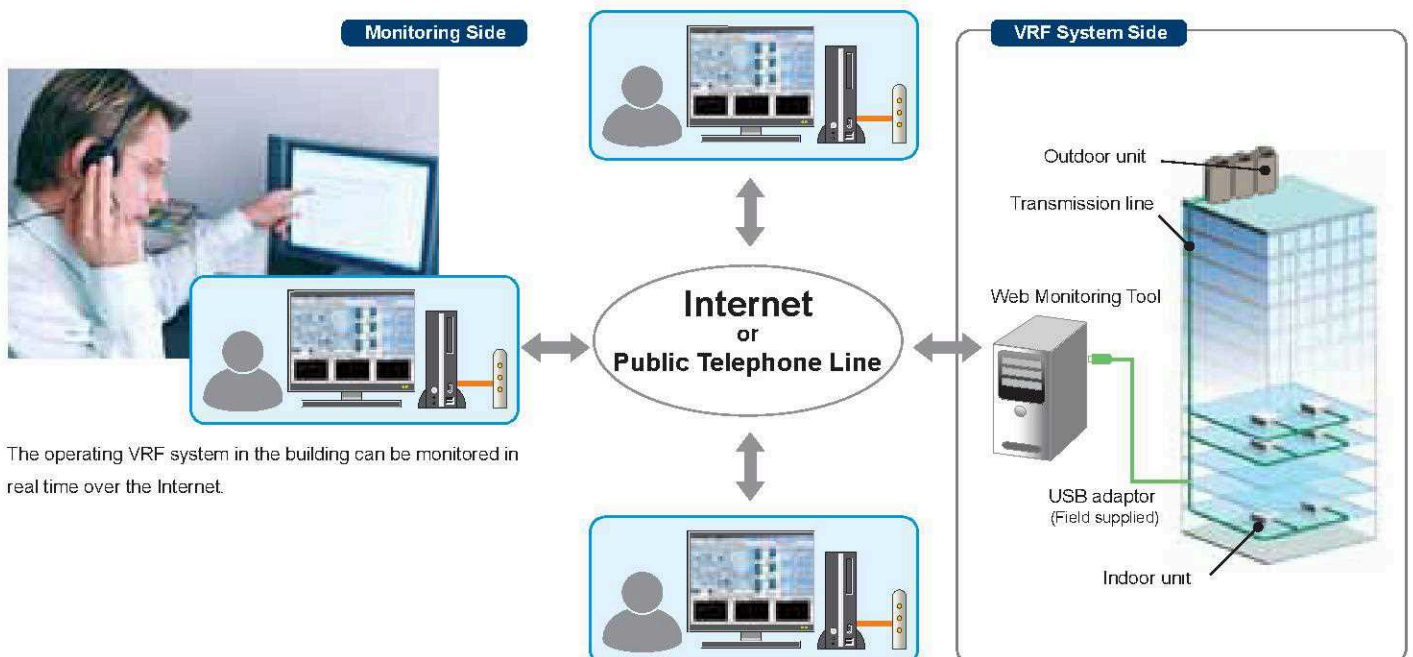

The operating VRF system in the building can be monitored in real time over the Internet.

# Easy Installation

From transportation of the product to address setting for commissioning, significant improvements have been made which reduce the cost of installation.

## Easily transported

### ■ Light weight

**20% weight reduction**  
(Than Previous model)

Note: In the case of 14HP

### ■ Easily craned into position using lifting belt hooks

Design of outdoor unit allows for lifting straps to be used

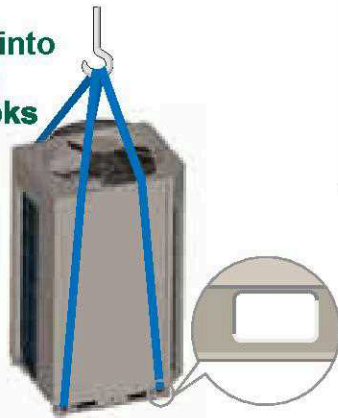

### ■ Can be transported in a small elevator

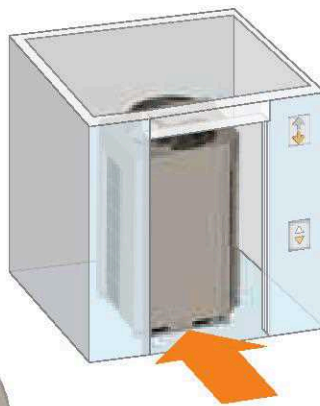

### ■ Transporting by forklift

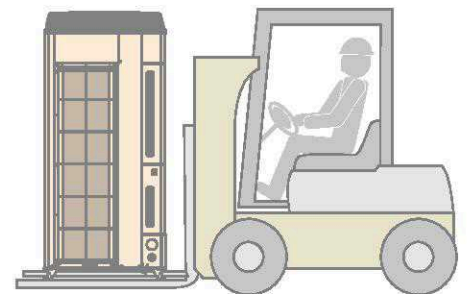

Transport with forklift is possible.

## Simple wiring & piping work

### ■ Simple signal line connection

Installation is made easier as the communications wiring can be connected continuously to any component.

**Up to maximum length 3,600m**

### V-II Series

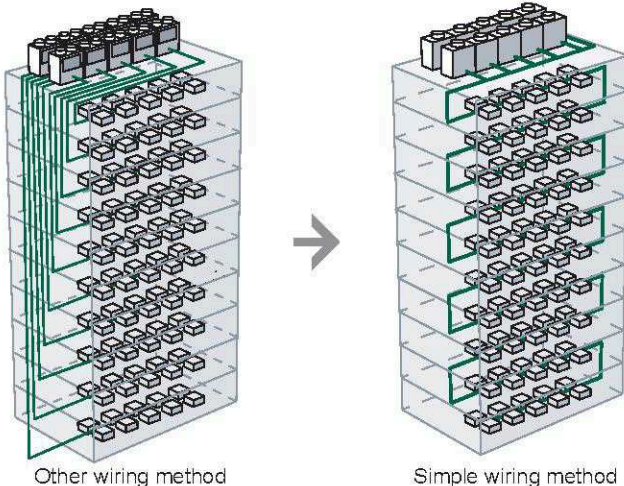

Note: In a multiple refrigerant system installation, Automatic addressing sequence cannot be initiated

### ■ Easy piping connection

The need for a oil equalization pipe as required on the previous model has been removed. The installation costs have been reduced by employing a Simple 2 pipe connection.

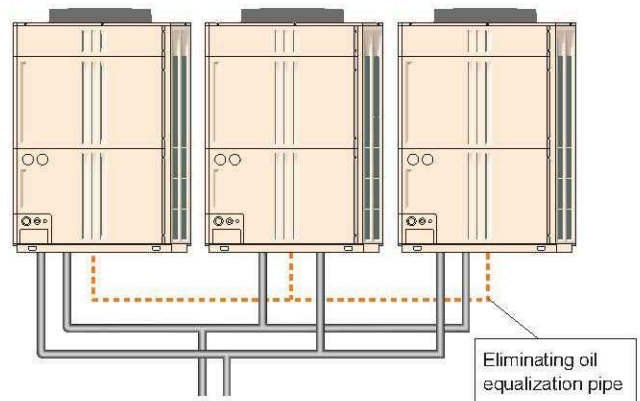

Eliminating oil equalization pipe



## Easy setting operation

### Automatic address setting

The address of each indoor unit can be automatically set by button switch of outdoor unit.

Press the pushbutton switch of outdoor unit.

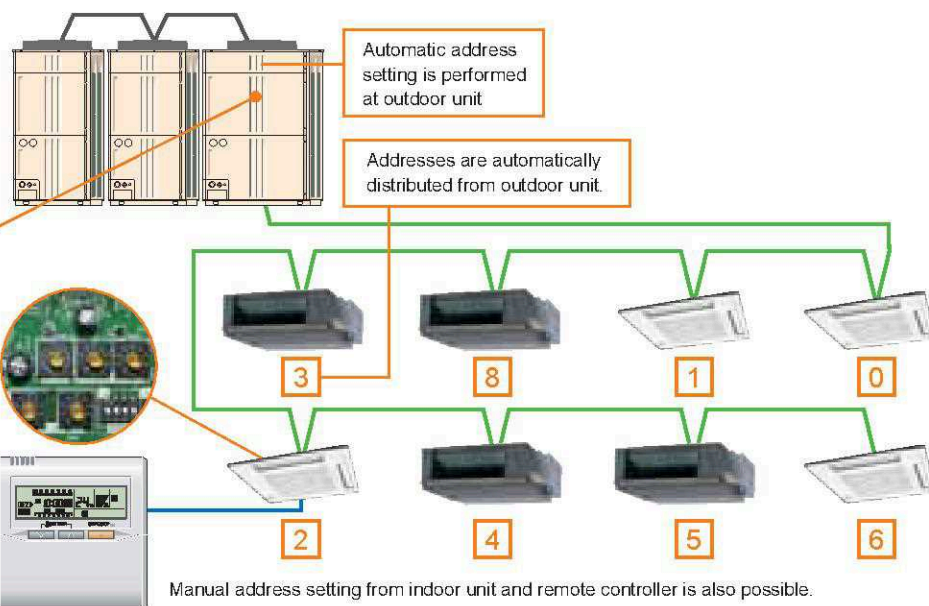

## Easy maintenance

### Easy access

By adopting a L-Shape front panel that can be removed, the work space for installation and service has been significantly expanded by this new design. For multiple installations, work is performed easily and efficiently even in a narrow space.

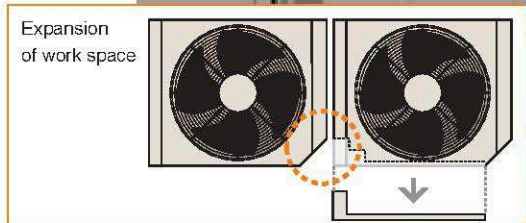
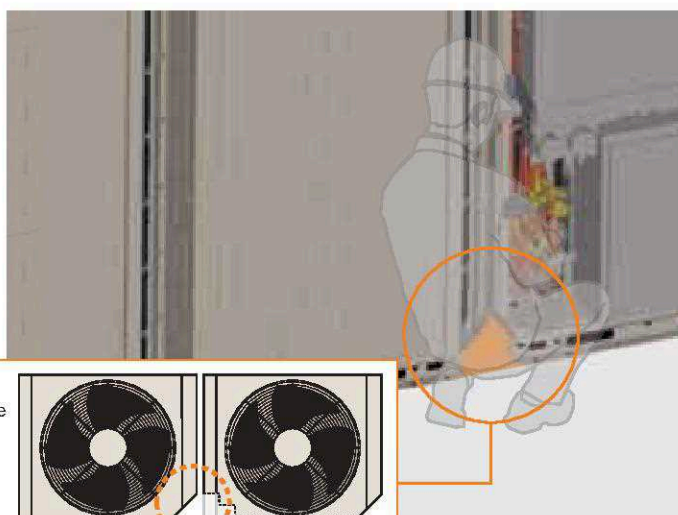

### Four way piping connection

Piping and wiring are available to the front, left and right, and bottom.

Four way connection

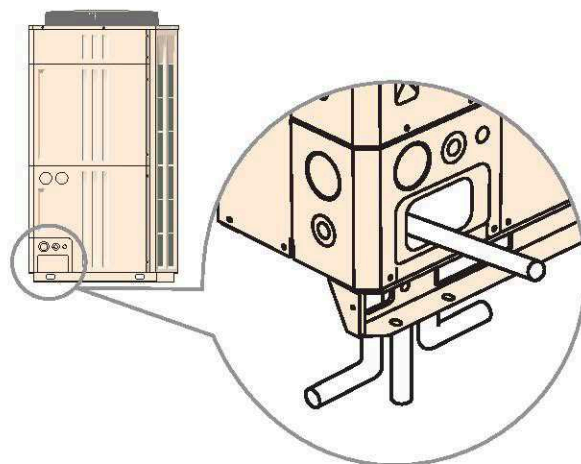

# Comfort and Convenience

Low noise, easy operational settings, and comfortable temperature adjustment allows for V-II systems to be used in building air conditioning applications.

## Quiet operation

### Low noise mode

Two low noise modes can be selected automatically by quiet priority setting and capacity priority setting depending on the usage environment and outside temperature load.

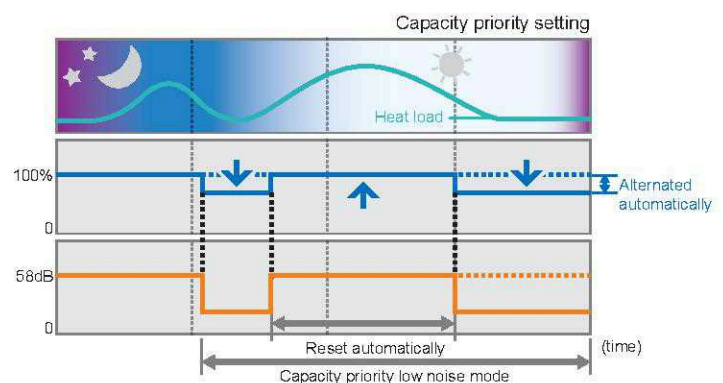
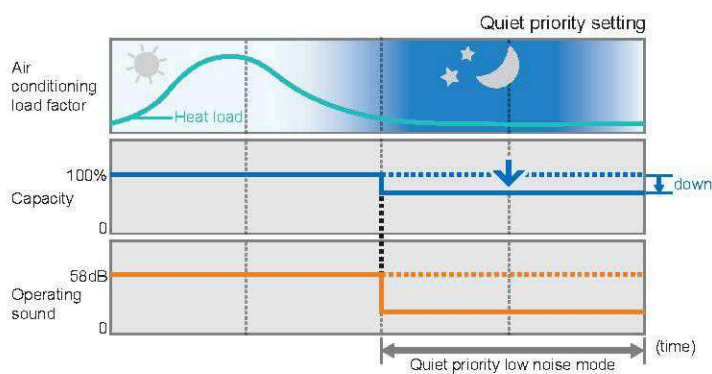

### Low noise design

Compressor noise has been significantly reduced by shielding the compressor compartment.

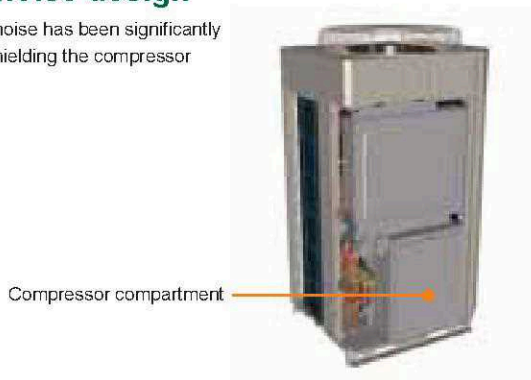

### Indoor unit

Low noise indoor unit lineup



## Auto changeover function

### Selectable auto changeover function

Auto changeover setting allows for the product to easily switch between Cooling and heating modes regardless of the operation mode of other indoor units. This can be done via specific indoor unit remote controller and/or by an external input control. This ensures comfortable operation all year round.

Command for operational mode switching is controlled by one of the following options.

1 selected from the following:

- 1 Various remote controllers connected to indoor unit
- 2 External input terminal of outdoor unit
- 3 System controller

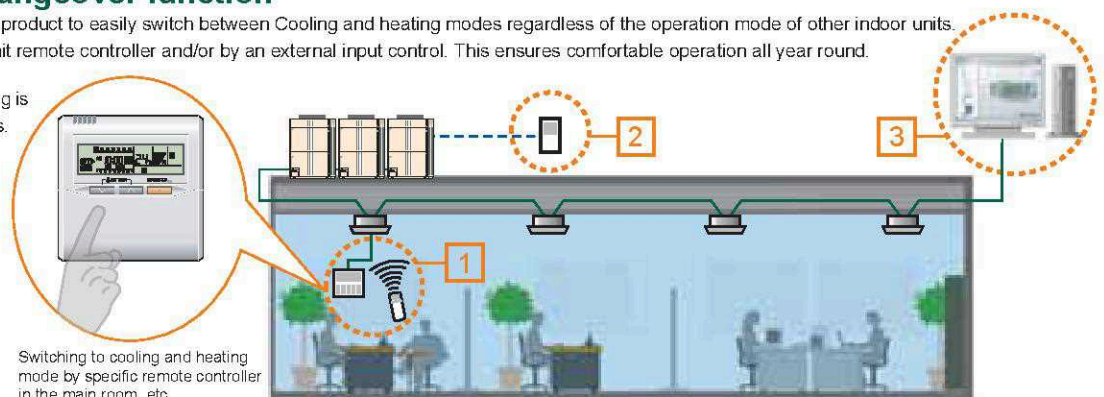



## Comfortable, convenient control

### Precision refrigerant flow control

Precision and Smooth refrigerant flow control is achieved by using a DC Inverter control in conjunction with individual indoor unit electronic expansion valve control.

This allows for a high precision comfortable temperature control of  $\pm 0.5^{\circ}\text{C}$ .

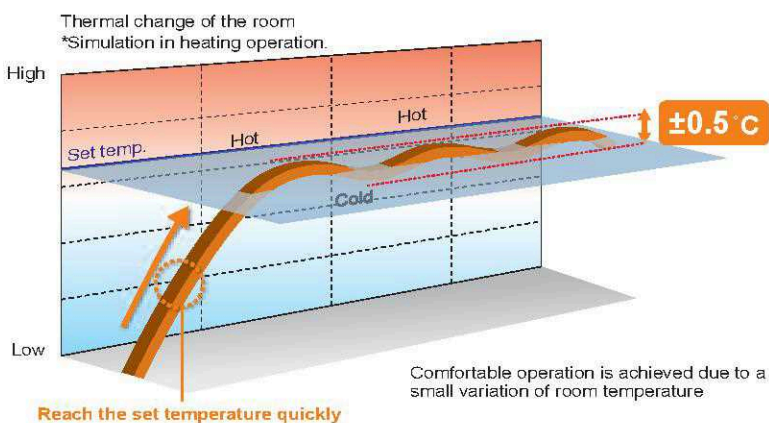

### Individual Air Conditioning Control

The desired temperature conditions of each room are met due to the Individual thermostat control of each indoor unit.

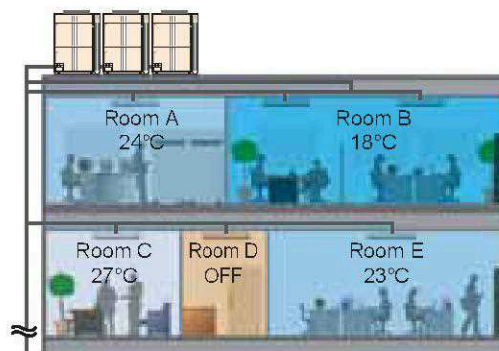

### Simple central management function



- Simple central control operation ..... Simple operation by icon display and color touch screen
- Yearly schedule function ..... Daily starting & stopping and temperature setting are managed.
- Clock setting function ..... The clock of each individual controller is periodically corrected.



Schedule screen

## Non-stop oil recovery operation

A comfortable room condition is maintained during oil recovery mode because the product continues to operate without stopping the cooling or heating operation.

Previous model

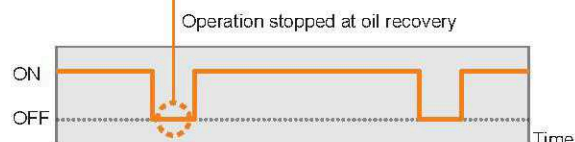

V-II Series

(Heating operation)



# Easy Service & Maintenance

Designed for Quick Service response,  
Easy maintenance and Troubleshooting

## Design for easy service and maintenance

- Inspection and replacement of main parts is easier due to innovative construction and an LED operational display.

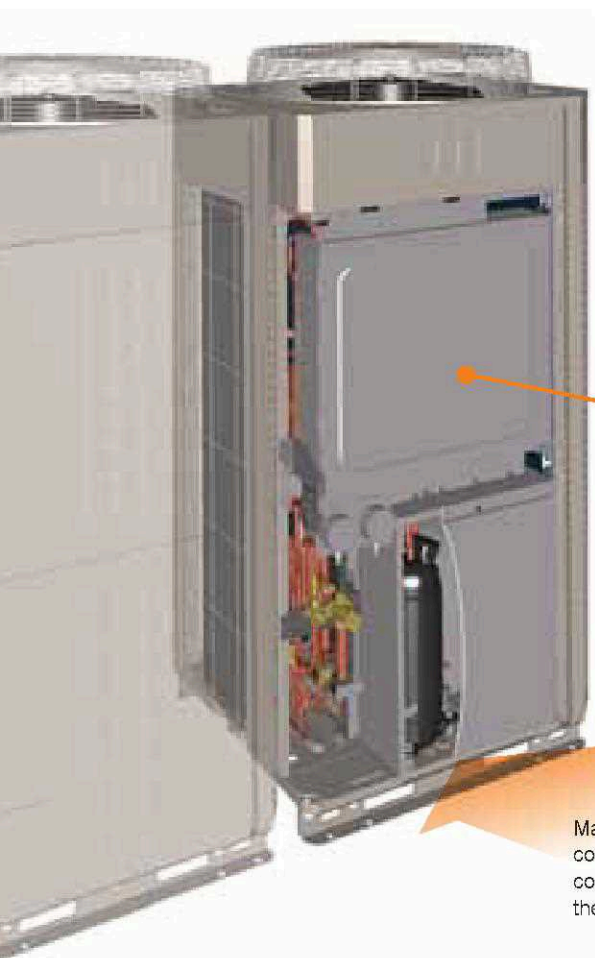

Consolidated electrical components make maintenance easy

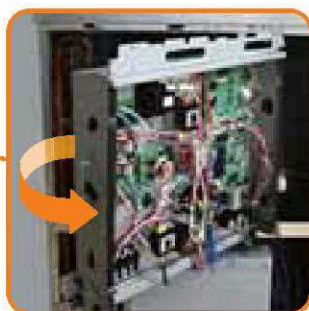

Movable PCB panel that allows for easier maintenance work behind the PCB

Maintenance of electrical components, valves, and compressor parts from the front is possible.

Easy-to-read 7-segment LED display which explains operational and trouble status

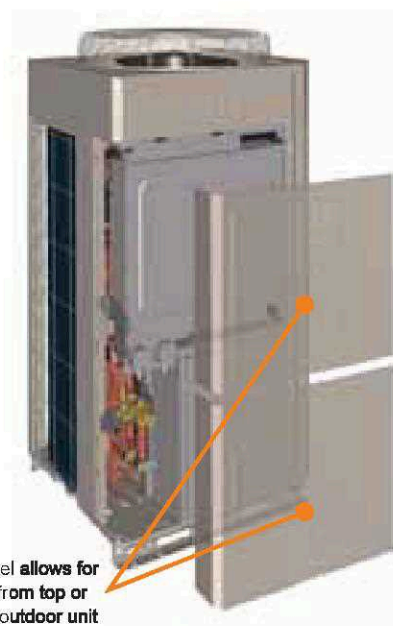
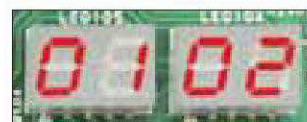

Split front panel **allows for** maintenance from top or bottom of the outdoor unit

### ■ Error status can be checked easily via the indoor unit wired controller

An error code is displayed on a liquid crystal screen.

Wired Remote Controller



Faulty unit number (Remote controller address)

Error code



Simple Remote Controller



Faulty unit number (Remote controller address)

Error code





## Emergency stop function

### Emergency stop

Emergency alarm can be received by indoor, outdoor units or Touch Panel Controller when they received it, all units will be stopped.

Note:  
In case of received Emergency alarm by Indoor/outdoor unit: All units connected within same refrigerant system will be stopped.  
Touch Panel Controller: all unit connected within VRF network system with Touch Panel Controller will be stopped.

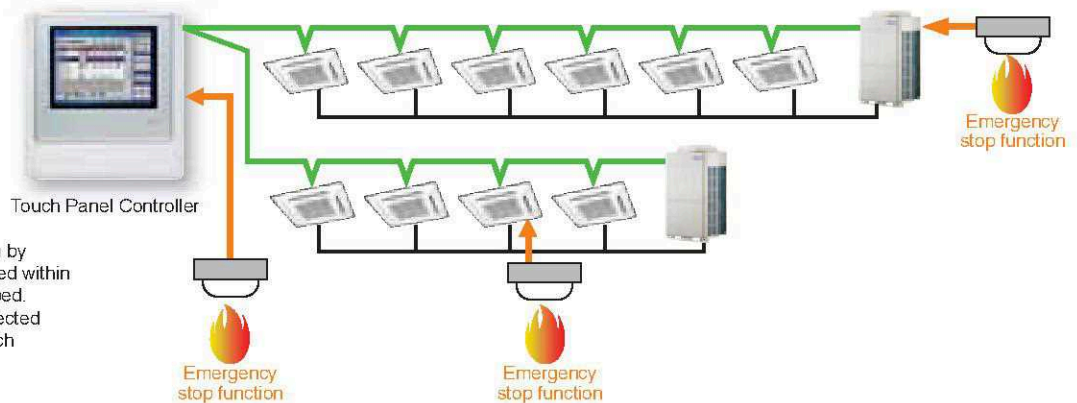

## Continuous operation during maintenance

### Non-stop operation

When servicing a specific indoor unit, maintenance can be performed even without turning off the other indoor units.

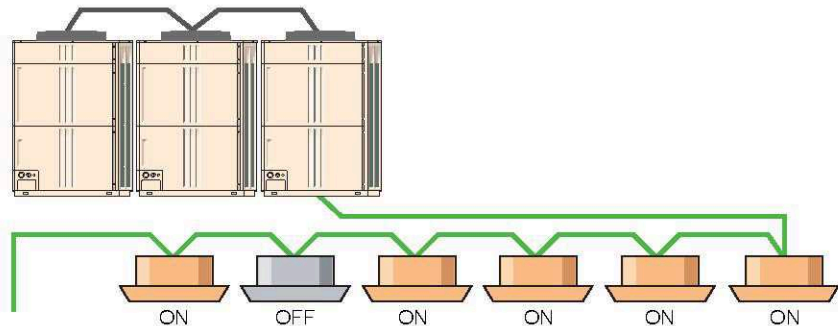

## Prompt trouble diagnosis

### Trouble diagnosis by Service Tool



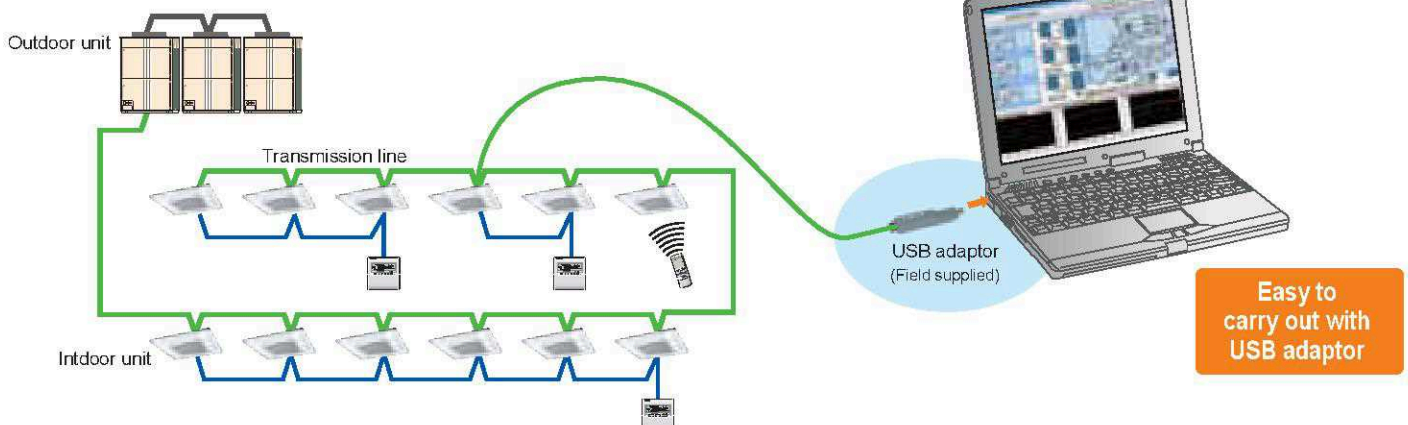











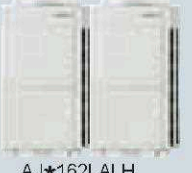

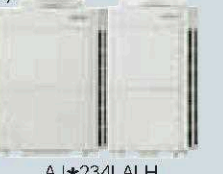
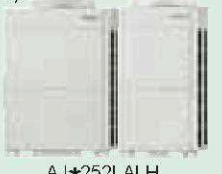

Suitable maintenance is possible by analysis of the operation data. Connection anywhere in the VRF network is easy.



# Outdoor Units Lineup

- Extensive line up from 8HP to 48HP in 2HP increments
- Space saving combination and Energy efficiency combination available, which can be selected to suit any air conditioning needs

## Space saving combination

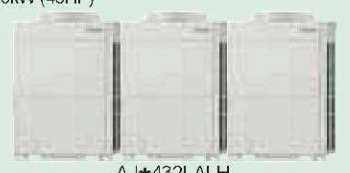
<p>22.4kW (8HP)</p>  <p>AJ★A72LALH UNIT : AJ★A72LALH</p>	<p>28.0kW (10HP)</p>  <p>AJ★A90LALH UNIT : AJ★A90LALH</p>	<p>33.5kW (12HP)</p>  <p>AJ★108LALH UNIT : AJ★108LALH</p>
<p>40.0kW (14HP)</p>  <p>AJ★126LALH UNIT : AJ★126LALH</p>	<p>45.0kW (16HP)</p>  <p>AJ★144LALH UNIT : AJ★144LALH</p>	<p>50.4kW (18HP)</p>  <p>AJ★162LALH UNIT : AJ★A90/A72LALH</p>
<p>55.9kW (20HP)</p>  <p>AJ★180LALH UNIT : AJ★108/A72LALH</p>	<p>61.5kW (22HP)</p>  <p>AJ★198LALH UNIT : AJ★108/A90LALH</p>	<p>67.0kW (24HP)</p>  <p>AJ★216LALH UNIT : AJ★108/108LALH</p>
<p>73.5kW (26HP)</p>  <p>AJ★234LALH UNIT : AJ★126/108LALH</p>	<p>78.5kW (28HP)</p>  <p>AJ★252LALH UNIT : AJ★144/108LALH</p>	<p>85.0kW (30HP)</p>  <p>AJ★270LALH UNIT : AJ★144/126LALH</p>
<p>90.0kW (32HP)</p>  <p>AJ★288LALH UNIT : AJ★144/144LALH</p>	<p>95.0kW (34HP)</p>  <p>AJ★306LALH UNIT : AJ★108/108/A90LALH</p>	<p>100.5kW (36HP)</p>  <p>AJ★324LALH UNIT : AJ★108/108/108LALH</p>
<p>107.0kW (38HP)</p>  <p>AJ★342LALH UNIT : AJ★126/108/108LALH</p>	<p>112.0kW (40HP)</p>  <p>AJ★360LALH UNIT : AJ★144/108/108LALH</p>	<p>118.5kW (42HP)</p>  <p>AJ★378LALH UNIT : AJ★144/126/108LALH</p>
<p>123.5kW (44HP)</p>  <p>AJ★396LALH UNIT : AJ★144/144/108LALH</p>	<p>130.0kW (46HP)</p>  <p>AJ★414LALH UNIT : AJ★144/144/126LALH</p>	<p>135.0kW (48HP)</p>  <p>AJ★432LALH UNIT : AJ★144/144/144LALH</p>

## Energy efficiency combination

44.8kW (16HP)

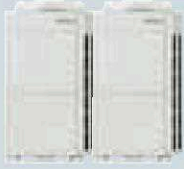

AJ\*144LALHH  
UNIT : AJ\*A72/A72LALH

62.4kW (22HP)

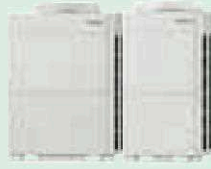

AJ\*198LALHH  
UNIT : AJ\*126/A72LALH

67.2kW (24HP)



AJ\*216LALHH  
UNIT : AJ\*A72/A72/A72LALH

72.8kW (26HP)

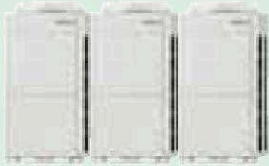

AJ\*234LALHH  
UNIT : AJ\*A90/A72/A72LALH

78.3kW (28HP)



AJ\*252LALHH  
UNIT : AJ\*108/A72/A72LALH

84.8kW (30HP)



AJ\*270LALHH  
UNIT : AJ\*126/A72/A72LALH

89.8kW (32HP)



AJ\*288LALHH  
UNIT : AJ\*108/108/A72LALH

95.9kW (34HP)



AJ\*306LALHH  
UNIT : AJ\*126/108/A72LALH

102.4kW (36HP)



AJ\*324LALHH  
UNIT : AJ\*126/126/A72LALH

113.5kW (40HP)

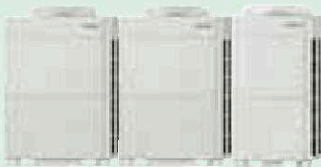

AJ\*360LALHH  
UNIT : AJ\*126/126/A108LALH

120.0kW (42HP)



AJ\*378LALHH  
UNIT : AJ\*126/126/126LALH

125.0kW (44HP)



AJ\*396LALHH  
UNIT : AJ\*144/126/126LALH

# Innovative Technology

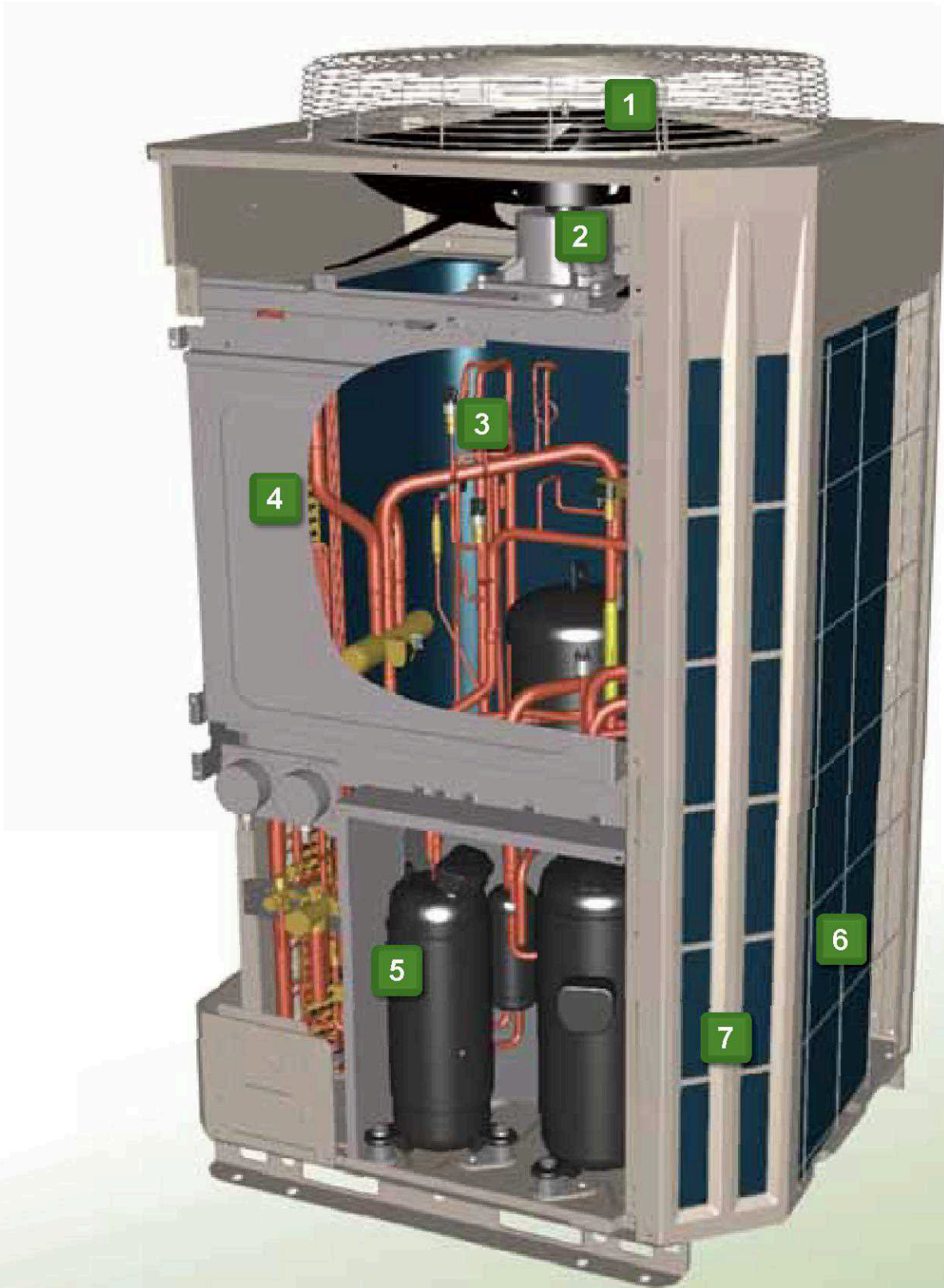

### 1 Powerful large propeller fan



By using CFD\*1 technology, A newly designed fan achieves high performance and low noise operation.

### 2 DC fan motor



High Performance and High Efficiency has been realized by using a small DC fan motor which has reduced power consumption by 25% when compared with the previous model.

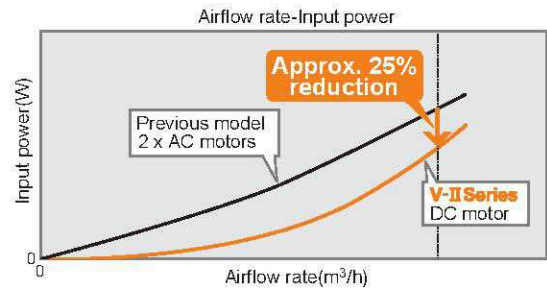

### 3 Subcool heat exchanger

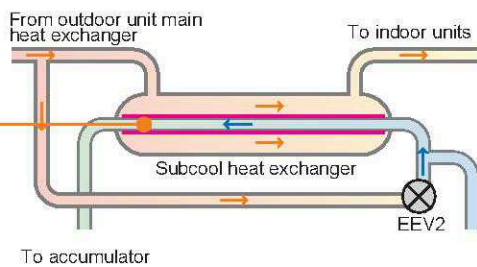

High Heat Exchange efficiency is achieved by using a internal projection shape double pipe construction.

### 4 Sine wave DC inverter control



A DC Sine wave inverter control has been used which allows for a high efficiency and high energy saving operation. Inverter losses are significantly reduced by newly adopted IPM and original motor control.

### 5 DC twin rotary compressor



A high performance, low noise, large capacity DC twin rotary compressor is used. Each part is optimized with intake and compression efficiency increased to the maximum extent. In addition, high performance and high quality is maintained by using a double accumulator.

### 6 Heat exchanger



Reduced compact size and energy saving has been realised by utilizing a  $\phi 7\text{mm}$  high density piping design with a unique enclosing shape. This new coil design allows for an increase of approximately 1.7 times heat exchanger volume when compared with the previous model.

### 7 Front intake port (omnidirectional intake)

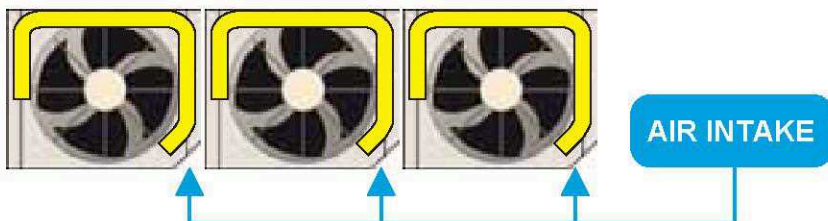



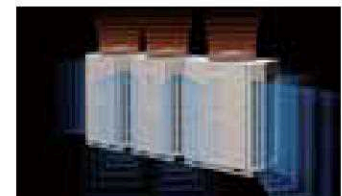

Front intake port is designed to prevent decreasing airflow when multiple outdoor units are installed.







\*1. CFD = Computational Fluid Dynamics

# Specifications

Space saving combination

Rating Capacity range		HP	8	10	12	14	16	18	20	22	24
											
Set Model			AJ*A72LALH	AJ*A90LALH	AJ*108LALH	AJ*126LALH	AJ*144LALH	AJ*162LALH	AJ*180LALH	AJ*198LALH	AJ*216LALH
Unit 1 Unit 2 Unit 3			AJ*A72LALH	AJ*A90LALH	AJ*108LALH	AJ*126LALH	AJ*144LALH	AJ*A90LALH AJ*A72LALH	AJ*108LALH AJ*A72LALH	AJ*108LALH AJ*A90LALH	AJ*108LALH AJ*108LALH
Maximum Connectable Indoor Unit*1			15	16	17	21	24	32	32	32	35
Indoor unit connectable capacity		Cooling kW	11.2-33.6	14.0-42.0	16.8-50.2	20.0-60.0	22.4-67.2	25.2-75.6	28.0-83.9	30.8-92.3	33.5-100.5
Power source											
Capacity	Cooling	kW	22.4	28.0	33.5	40.0	45.0	50.4	55.9	61.5	67.0
	Heating	kW	25.0	31.5	37.5	45.0	50.0	56.5	62.5	69.0	75.0
Input power	Cooling	kW	5.51	7.73	9.62	11.53	14.17	13.24	15.13	17.35	19.24
	Heating	kW	5.72	7.83	9.28	11.45	12.60	13.55	15.00	17.11	18.56
EER	Cooling	W/W	4.07	3.62	3.48	3.47	3.18	3.81	3.69	3.54	3.48
COP	Heating	W/W	4.37	4.02	4.04	3.93	3.97	4.17	4.17	4.03	4.04
Airflow rate	High	m³/h	11,000	11,000	12,000	14,000	14,000	11,000 x 2	12,000+11,000	12,000+11,000	12,000 x 2
Sound pressure level*2	Cooling	dB (A)	*	*	*	*	*	*	*	*	*
	Heating	dB (A)	*	*	*	*	*	*	*	*	*
Maximum external static pressure	Pa		80	80	80	80	80	80	80	80	80
Compressor motor output	kW		3.9	3.9	3.9 + 4.5	3.9 + 4.5	3.9 + 4.5	3.9 x 2	3.9 x 2 + 4.5	3.9 x 2 + 4.5	3.9 x 2 + 4.5 x 2
Heat exchanger fin			Blue fin	Blue fin	Blue fin	Blue fin	Blue fin	Blue fin	Blue fin	Blue fin	Blue fin
Dimensions	Height	mm	1,690	1,690	1,690	1,690	1,690	1,690	1,690	1,690	1,690
	Width	mm	930	930	930	1,240	1,240	930 x 2	930 x 2	930 x 2	930 x 2
	Depth	mm	765	765	765	765	765	765	765	765	765
Weight	kg		221	221	266	289	289	221+221	266+221	266+221	266+266
Refrigerant charge	kg		11.2	11.2	11.8	11.8	11.8	11.2 x 2	11.8 + 11.2	11.8 + 11.2	11.8 x 2
Connection pipe diameter	Liquid	mm	12.70	12.70	12.70	12.70	12.70	15.88	15.88	15.88	15.88
	Gas	mm	22.20	22.20	28.58	28.58	28.58	28.58	28.58	34.92	34.92
Operation temperature range	Cooling	°C	-15 to 46	-15 to 46	-15 to 46	-15 to 46	-15 to 46	-5 to 46	-5 to 46	-5 to 46	-5 to 46
	Heating	°C	-20 to 21	-20 to 21	-20 to 21	-20 to 21	-20 to 21	-20 to 21	-20 to 21	-20 to 21	-20 to 21

Energy efficiency combination

Rating Capacity range		HP	16	22	24	26	28	30		
										
Set Model			AJ*144LALHH	AJ*198LALHH	AJ*216LALHH	AJ*234LALHH	AJ*252LALHH	AJ*270LALHH		
Unit 1 Unit 2 Unit 3			AJ*A72LALH AJ*A72LALH	AJ*126LALH AJ*A72LALH	AJ*A72LALH AJ*A72LALH AJ*A72LALH	AJ*A90LALH AJ*A72LALH AJ*A72LALH	AJ*108LALH AJ*A72LALH AJ*A72LALH	AJ*126LALH AJ*A72LALH AJ*A72LALH		
Maximum Connectable Indoor Unit*1			30	33	36	39	42	45		
Indoor unit connectable capacity		Cooling kW	22.4-67.2	31.2-93.6	33.6-100.8	36.4-109.2	39.2-117.4	42.4-127.2		
Power source										
Capacity	Cooling	kW	44.8	62.4	67.2	72.8	78.3	84.8		
	Heating	kW	50.0	70.0	75.0	81.5	87.5	95.0		
Input power	Cooling	kW	11.02	17.04	18.53	18.75	20.64	22.55		
	Heating	kW	11.44	17.17	17.16	19.27	20.72	22.89		
EER	Cooling	W/W	4.07	3.66	4.07	3.88	3.79	3.76		
COP	Heating	W/W	4.37	4.08	4.37	4.23	4.22	4.15		
Airflow rate	High	m³/h	11,000 x 2	14,000 + 11,000	11,000 x 3	11,000 x 3	12,000+11,000 x 2	14,000+11,000 x 2		
Sound pressure level*2	Cooling	dB (A)	*	*	*	*	*	*		
	Heating	dB (A)	*	*	*	*	*	*		
Maximum external static pressure	Pa		80	80	80	80	80	80		
Compressor motor output	kW		3.9 x 2	3.9 x 2+4.5	3.9 x 3	3.9 x 3	3.9 x 3+4.5	3.9 x 3+4.5		
Heat exchanger fin			Blue fin	Blue fin	Blue fin	Blue fin	Blue fin	Blue fin		
Dimensions	Height	mm	1,690	1,690	1,690	1,690	1,690	1,690		
	Width	mm	930 x 2	930+1,240	930 x 3	930 x 3	930 x 3	930 x 2+1,240		
	Depth	mm	765	765	765	765	765	765		
Weight	kg		221+221	289+221	221+221+221	221+221+221	266+221+221	289+221+221		
Refrigerant charge	kg		11.2 x 2	11.8+11.2	11.2 x 3	11.2 x 3	11.8 + 11.2 x 2	11.8+11.2 x 2		
Connection pipe diameter	Liquid	mm	12.70	15.88	15.88	15.88	15.88	19.05		
	Gas	mm	28.58	34.92	34.92	34.92	34.92	34.92		
Operation temperature range	Cooling	°C	-5 to 46	-5 to 46	-5 to 46	-5 to 46	-5 to 46	-5 to 46		
	Heating	°C	-20 to 21	-20 to 21	-20 to 21	-20 to 21	-20 to 21	-20 to 21		

AJ\* : AJY(FUJITSU), AJH(GENERAL)

Note : Specifications are based on the following conditions.  
 Cooling : Indoor temperature of 27°CDB / 19°CWB, and outdoor temperature of 35°CDB / 24°CWB.  
 Heating : Indoor temperature of 20°CDB / (15°CWB), and outdoor temperature of 7°CDB / 6°CWB.  
 Pipe length : 7.5 m, Height difference between outdoor unit and indoor unit : 0 m.  
 When cooling operation will be conducted at outdoor air temperature below -5°C,  
 the outdoor unit must be installed in a position that is higher than or equal to those of indoor units.

\*1 Minimum connectable indoor unit number is 2.  
 However ARXC72 and ARXC90 can be used signal connection.  
 \*2 The noise value is the value when measured in an anechoic room.  
 When measured in the actual installed state, surrounding noise and reflections are received and the measured value is usually larger than the indicated value.  
 \*: Data were not available at time of publication.

26	28	30	32	34	36	38	40	42	44	46	48
AJ*234LALH AJ*108LALH	AJ*252LALH AJ*108LALH	AJ*270LALH AJ*126LALH	AJ*288LALH AJ*144LALH	AJ*306LALH AJ*108LALH AJ*108LALH AJ*A90LALH	AJ*324LALH AJ*108LALH AJ*108LALH	AJ*342LALH AJ*126LALH AJ*108LALH AJ*108LALH	AJ*360LALH AJ*144LALH AJ*108LALH AJ*108LALH	AJ*378LALH AJ*144LALH AJ*126LALH AJ*108LALH	AJ*396LALH AJ*144LALH AJ*144LALH AJ*108LALH	AJ*414LALH AJ*144LALH AJ*144LALH AJ*126LALH	AJ*432LALH AJ*144LALH AJ*144LALH AJ*144LALH
39	42	45	48	48	48	48	48	48	48	48	48
36.8-110.3	39.3-117.8	42.5-127.5	45.0-135.0	47.5-142.5	50.3-150.8	53.5-160.5	56.0-168.0	59.3-177.8	61.8-185.3	65.0-195.0	67.5-202.5

3-phase 4 wire, 400 V, 50Hz											
73.5	78.5	85.0	90.0	95.0	100.5	107.0	112.0	118.5	123.5	130.0	135.0
82.5	87.5	95.0	100.0	106.5	112.5	120.0	125.0	132.5	137.5	145.0	150.0
21.15	23.79	25.70	28.34	26.97	28.86	30.77	33.41	35.32	37.96	39.87	42.51
20.73	21.88	24.05	25.20	26.39	27.84	30.01	31.16	33.33	34.48	36.65	37.80
3.48	3.30	3.31	3.18	3.52	3.48	3.48	3.35	3.36	3.25	3.26	3.18
3.98	4.00	3.95	3.97	4.04	4.04	4.00	4.01	3.98	3.99	3.96	3.97
14,000x12,000	14,000x12,000	14,000 x 2	14,000 x 2	12,000x2+11,000	12,000 x 3	14,000+12,000x2	14,000+12,000x2	14,000x2+12,000	14,000x2+12,000	14,000 x 3	14,000 x 3
*	*	*	*	*	*	*	*	*	*	*	*
*	*	*	*	*	*	*	*	*	*	*	*
80	80	80	80	80	80	80	80	80	80	80	80
3.9x2+4.5x2	3.9x2+4.5x2	3.9x2+4.5x2	3.9x2+4.5x2	3.9x3+4.5x2	3.9x3+4.5x3	3.9x3+4.5x3	3.9x3+4.5x3	3.9x3+4.5x3	3.9x3+4.5x3	3.9x3+4.5x3	3.9x3+4.5x3
Blue fin	Blue fin	Blue fin	Blue fin	Blue fin	Blue fin	Blue fin	Blue fin	Blue fin	Blue fin	Blue fin	Blue fin
1,690	1,690	1,690	1,690	1,690	1,690	1,690	1,690	1,690	1,690	1,690	1,690
930+1,240	930+1,240	1,240 x 2	1,240 x 2	930 x 3	930 x 3	930 x 2 + 1,240	930 x 2 + 1,240	930 + 1,240 x 2	930 + 1,240 x 2	1,240 x 3	1,240 x 3
765	765	765	765	765	765	765	765	765	765	765	765
289+266	289+266	289+289	289+289	266+266+221	266+266+266	289+266+266	289+266+266	289+289+266	289+289+266	289+289+289	289+289+289
11.8 x 2	11.8 x 2	11.8 x 2	11.8 x 2	11.8 x 2 + 11.2	11.8 x 3	11.8 x 3	11.8 x 3	11.8 x 3	11.8 x 3	11.8 x 3	11.8 x 3
15.88	15.88	19.05	19.05	19.05	19.05	19.05	19.05	19.05	19.05	19.05	19.05
34.92	34.92	34.92	34.92	34.92	41.27	41.27	41.27	41.27	41.27	41.27	41.27
-5 to 46	-5 to 46	-5 to 46	-5 to 46	-5 to 46	-5 to 46	-5 to 46	-5 to 46	-5 to 46	-5 to 46	-5 to 46	-5 to 46
-20 to 21	-20 to 21	-20 to 21	-20 to 21	-20 to 21	-20 to 21	-20 to 21	-20 to 21	-20 to 21	-20 to 21	-20 to 21	-20 to 21

32	34	36	40	42	44
AJ*108LALH AJ*108LALH AJ*A72LALH	AJ*126LALH AJ*108LALH AJ*A72LALH	AJ*126LALH AJ*126LALH AJ*A72LALH	AJ*126LALH AJ*126LALH AJ*A108LALH	AJ*126LALH AJ*126LALH AJ*126LALH	AJ*144LALH AJ*126LALH AJ*126LALH
48	48	48	48	48	48
44.9-134.7	48.0-143.8	51.2-153.6	56.8-170.2	60.0-180.0	62.5-187.5

3-phase 4 wire, 400 V, 50Hz					
89.4	95.9	102.4	113.5	120.0	125.0
100.0	107.5	115.0	127.5	135.0	140.0
24.75	26.66	28.57	32.68	34.59	37.23
24.28	26.45	28.62	32.18	34.35	35.50
3.61	3.60	3.58	3.47	3.47	3.36
4.12	4.06	4.02	3.96	3.93	3.94
12,000 x 2+11,000	14,000+12,000+11,000	14,000 x 2+11,000	14,000 x 2+12,000	14,000 x 3	14,000 x 3
*	*	*	*	*	*
*	*	*	*	*	*
80	80	80	80	80	80
3.9 x 3+4.5 x 2	3.9 x 3+4.5 x 2	3.9 x 3+4.5 x 2	3.9 x 3+4.5 x 3	3.9 x 3+4.5 x 3	3.9 x 3+4.5 x 3
Blue fin	Blue fin	Blue fin	Blue fin	Blue fin	Blue fin
1,690	1,690	1,690	1,690	1,690	1,690
930 x 3	930 x 2+1,240	930+1,240 x 2	930+1,240 x 2	1,240 x 3	1,240 x 3
765	765	765	765	765	765
266+266+221	289+266+221	289+289+221	289+289+266	289+289+289	289+289+289
11.8 x 2+11.2	11.8 x 2+11.2	11.8 x 2+11.2	11.8 x 3	11.8 x 3	11.8 x 3
19.05	19.05	19.05	19.05	19.05	19.05
34.92	34.92	41.27	41.27	41.27	41.27
-5 to 46	-5 to 46	-5 to 46	-5 to 46	-5 to 46	-5 to 46
-20 to 21	-20 to 21	-20 to 21	-20 to 21	-20 to 21	-20 to 21

# Dimensions

## 8, 10, 12HP

- AJ\*A72LALH
- AJ\*A90LALH
- AJ\*108LALH

(Unit : mm)

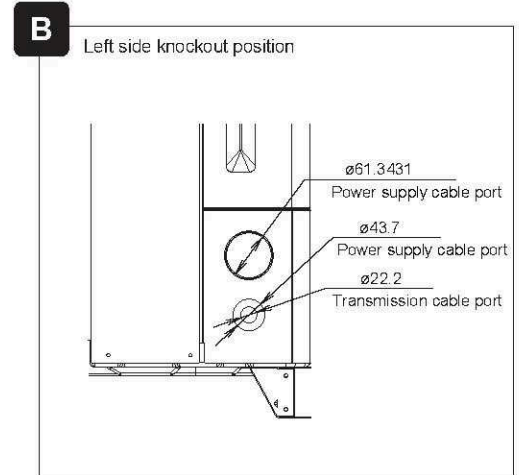
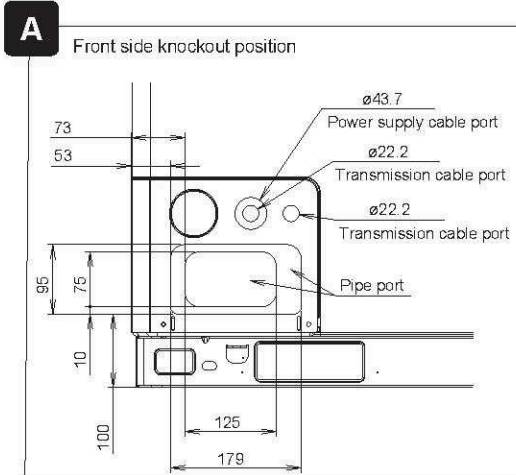
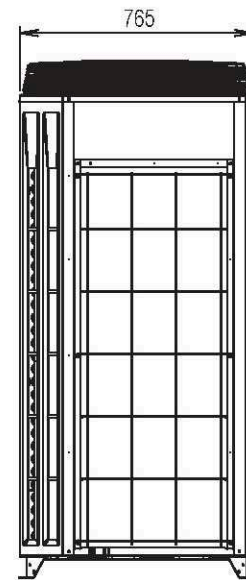
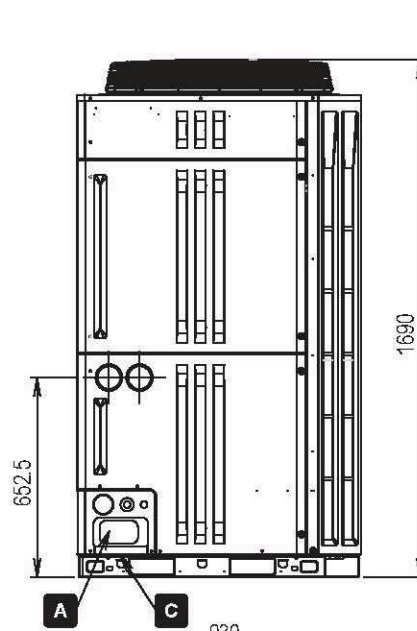
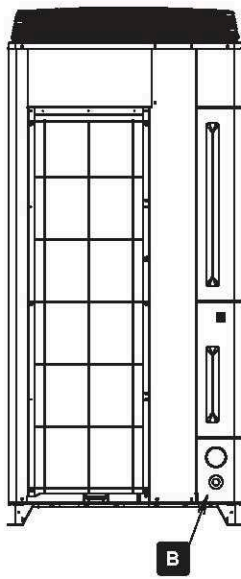
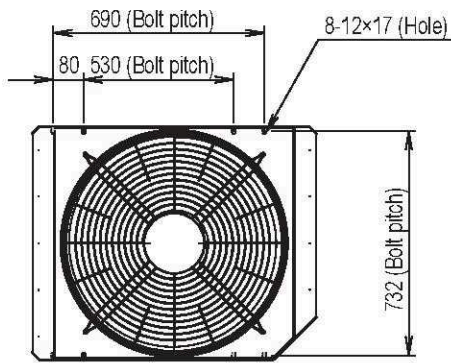



**14, 16HP**

AJ\*126LALH  
AJ\*144LALH

(Unit : mm)

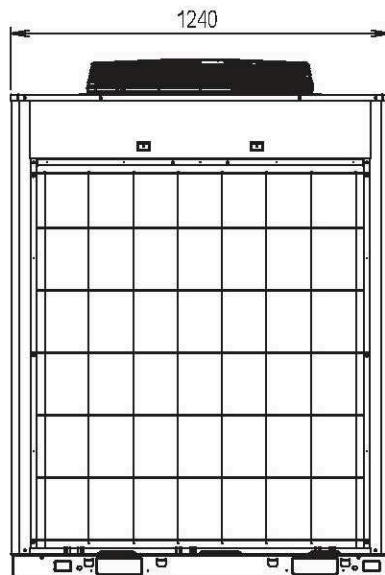
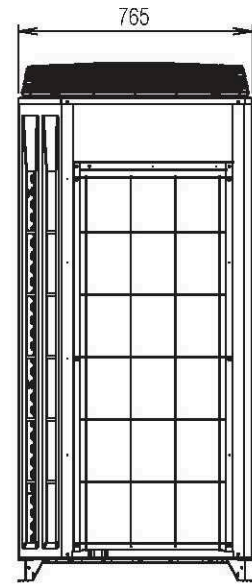
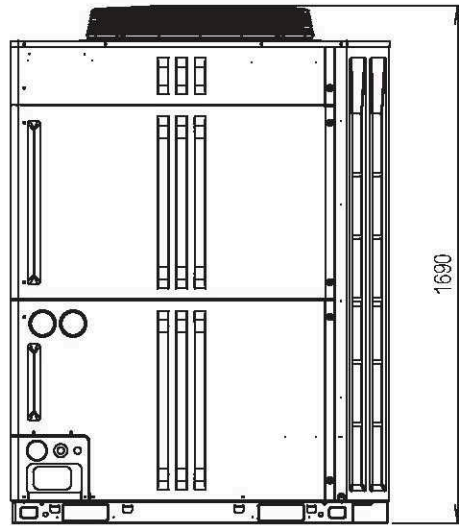
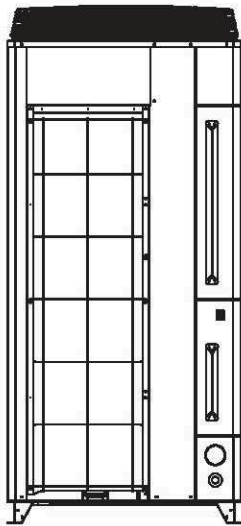
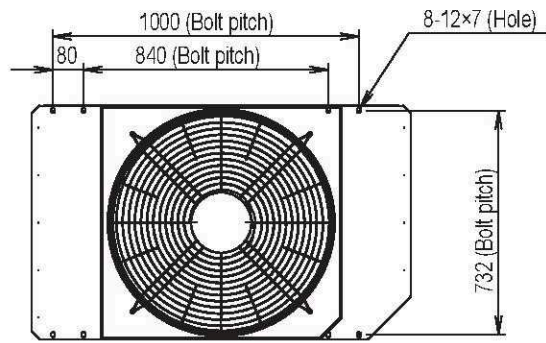

**C**



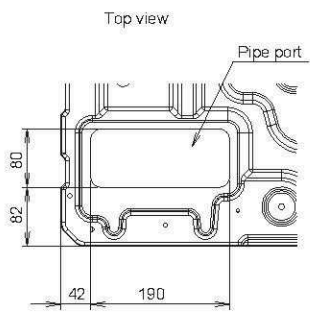

























Bottom side knockout position























# Indoor Unit Lineup

**11 Types, 49 Models, Capacity range from 2.2kW to 25.0kW**

Comprehensive range of indoor units of variety design and capacity ranges available which can be selected to suit any air conditioning needs.

Rating Capacity Range (kW)	2.2	2.8	3.6	4.5	5.6	7.1
Model code	7	9	12	14	18	24
Compact Cassette P26	 AUXB07LALH	 AUXB09LALH	 AUXB12LALH	 AUXB14LALH	 AUXB18LALH	 AUXB24LALH
Cassette P28					 AUXD18LALH	 AUXD24LALH
Compact Duct P30	 ARXB07LALH	 ARXB09LALH	 ARXB12LALH	 ARXB14LALH	 ARXB18LALH	
Low Static Pressure Duct P32						 ARXB24LATH
Duct P32						 ARXA24LATH
High Static Pressure Duct P34						
Floor / Ceiling P36			 AB*A12LATH	 AB*A14LATH	 AB*A18LATH	 AB*A24LATH
Ceiling P38						
Compact Wall Mounted (EEV internal) P40	 AS*A07LACH	 AS*A09LACH	 AS*A12LACH	 AS*A14LACH		
Compact Wall Mounted (EEV external) P40	 AS*E07LACH	 AS*E09LACH	 AS*E12LACH	 AS*E14LACH		
	With this model connection of EV kit is necessary.					
Wall Mounted P42					 AS*A18LATH	 AS*A24LATH

The indoor units above cannot be connected to the S or V Series.  
 AB\* : ABY(FUJITSU), ABH(GENERAL) AS\* : ASY(FUJITSU), ASH(GENERAL)

9.0	11.2	12.5	14.0	18.0	22.4	25.0
30	36	45	54	60	72	90
 AUXA30LALH	 AUXA36LALH	 AUXA45LALH	 AUXA54LALH			
 ARXB30LATH	 ARXB36LATH	 ARXB45LATH				
 ARXA30LATH	 ARXA36LATH	 ARXA45LATH				
	 ARXC36LATH	 ARXC45LATH		 ARXC60LATH	 ARXC72LATH	 ARXC90LATH
 AB*A30LATH	 AB*A36LATH	 AB*A45LATH	 AB*A54LATH			
 AS*A30LATH						

# Compact Cassette

Compact size panel design that fits standard ceiling panel (600x600mm)

## Models

- AUXB07LALH
- AUXB09LALH
- AUXB12LALH
- AUXB14LALH
- AUXB18LALH
- AUXB24LALH



## 2-stage turbo fan

High efficiency design by 2 stage structure

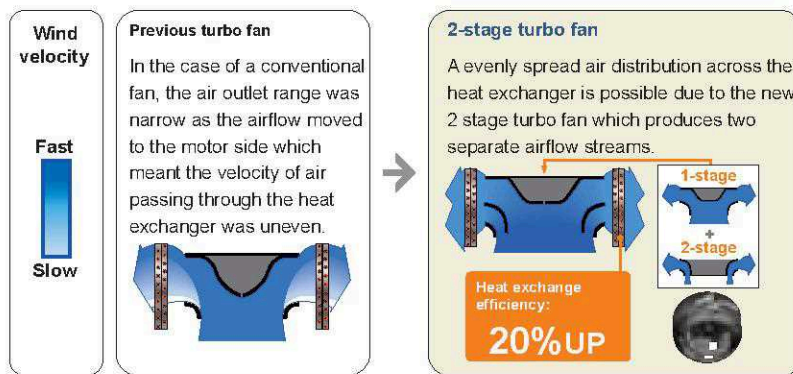

## Quiet quality

Optimization of wing form (laminar wing type) and wing number (7 blades each)

Designed by CFD-analysis (fluid) simulations

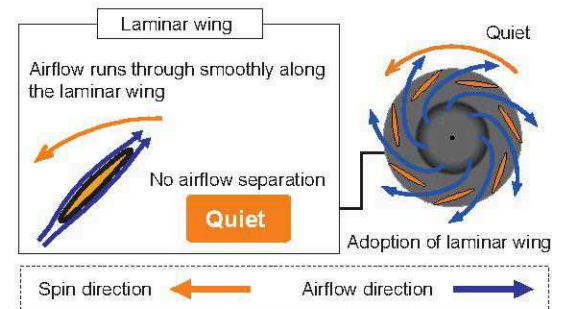

## Specifications

Model name		AUXB07LALH	AUXB09LALH	AUXB12LALH	AUXB14LALH	AUXB18LALH	AUXB24LALH
Power source		230V~50Hz					
Capacity	Cooling	2.2	2.8	3.6	4.5	5.6	7.1
	Heating	2.8	3.2	4.1	5.0	6.3	8.0
Input power		25		29	35	36	84
Airflow rate	High	540	550	600	680	690	1,030
	Med	450	450	530	570	580	830
	Low	350	350	390	390	400	450
Sound pressure level	High	34	35	37	38	41	50
	Med	30	30	34	34	35	44
	Low	25	25	27	27	27	30
Dimensions (H x W x D)		mm 245 x 570 x 570					
Weight		kg 15				kg 17	
Connection pipe diameter	Liquid (Flare)	mm ø6.35				mm ø9.52	
	Gas (Flare)	mm ø12.70				mm ø15.88	
	Drain	mm ø25 (I.D.); ø32 (O.D.)					
Grille(option)	Model name	UTG-UF*B-W					
	Dimensions (H x W x D)	mm 50 x 700 x 700					
	Weight	kg 2.6					

F\* : FY (FUJITSU) ; FG (GENERAL)

Note : Specifications are based on the following conditions.

Cooling : Indoor temperature of 27°CDB / 19°CWB, and outdoor temperature of 35°CDB / 24°CWB

Heating : Indoor temperature of 20°CDB / (15°CWB), and outdoor temperature of 7°CDB / 6°CWB

Pipe length : 7.5 m; Height difference between outdoor unit and indoor unit : 0 m.

Voltage : 230 [V].

## Easy maintenance

### ① Maintenance of fan motor and fan

Maintenance of the fan motor and fan can be done easily after taking off the panel as the bell mouth of the fan can be removed easily.

A : Fan motor    B : 2-stage turbo fan  
C : Bell-mouth    D : Panel

### ② Long life filter

: standard equipment

### ③ Adaptation of transparent drainage parts

During installation, maintenance and operation, the drain pump and kit can be checked easily.

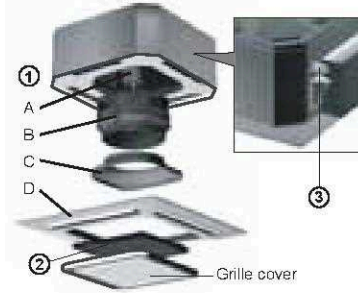

## High ceiling mode

This compact cassette can be installed up to a height of 3.5 metres whilst still ensuring sufficient air at lower levels of the room.

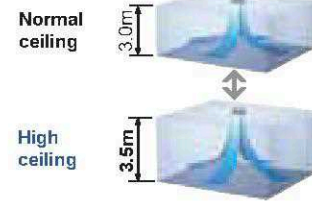

## Compact design

World's first 24,000Btu model in the compact cassette category

(Easy installation by taking off ceiling panel of 600 x 600 size)

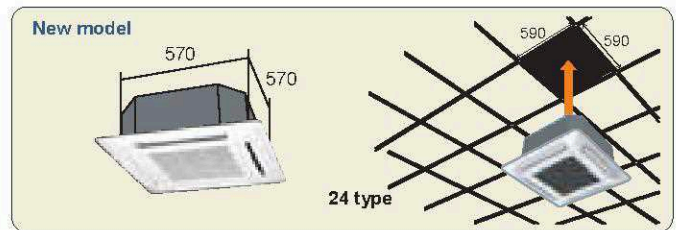
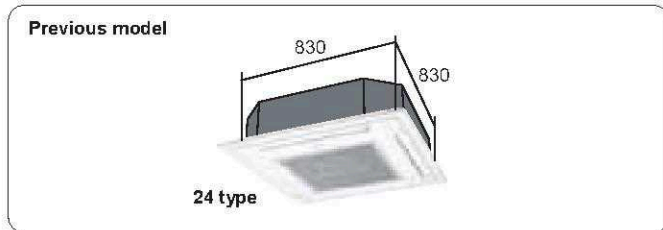

## High lift drain pump

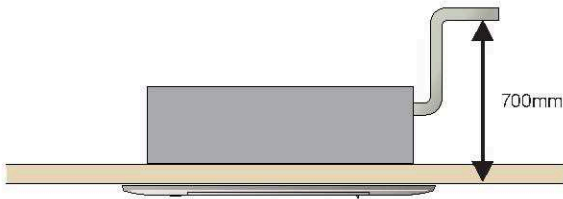

## Optional parts

Air Outlet Shutter Plate    UTR-YDZB

## Dimensions

Models: AUXB07 / AUXB09 / AUXB12 / AUXB14 / AUXB18 / AUXB24

(Unit : mm)

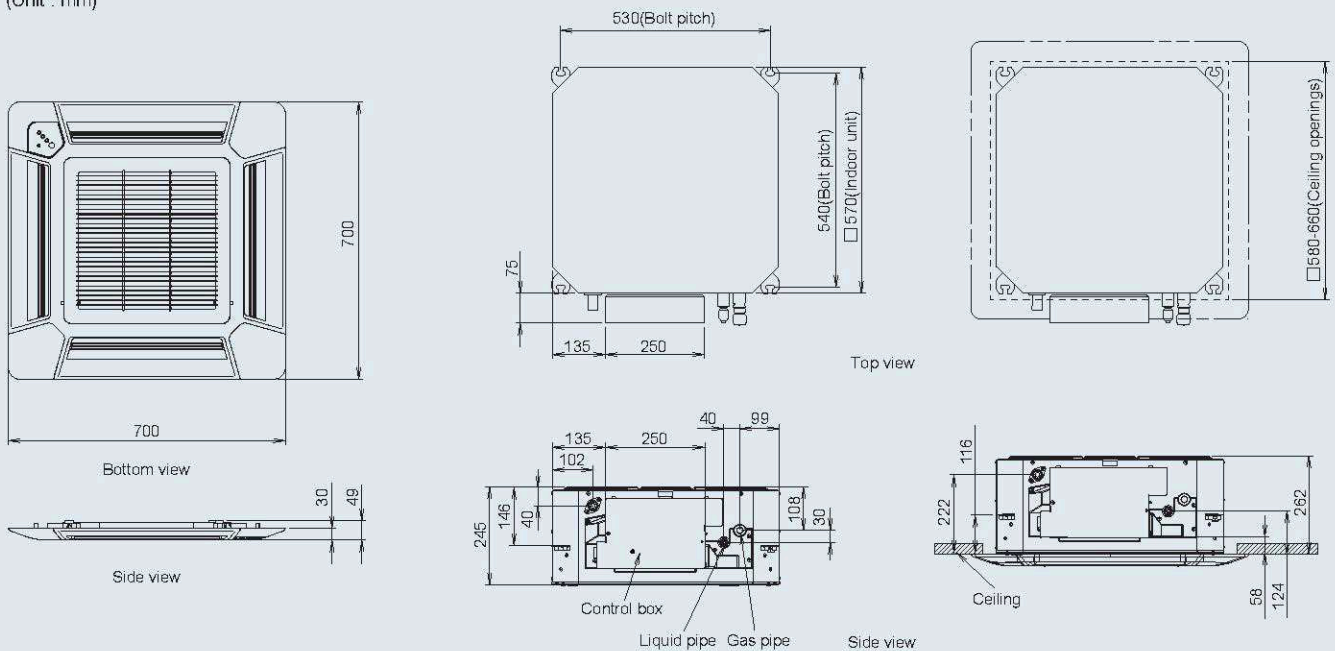

# Cassette

Powerful, wide airflow and quiet operation

Models

- AUXD18LALH
- AUXD24LALH
- AUXA30LALH
- AUXA36LALH
- AUXA45LALH
- AUXA54LALH



## High efficiency turbo fan with 3-dimensional blade

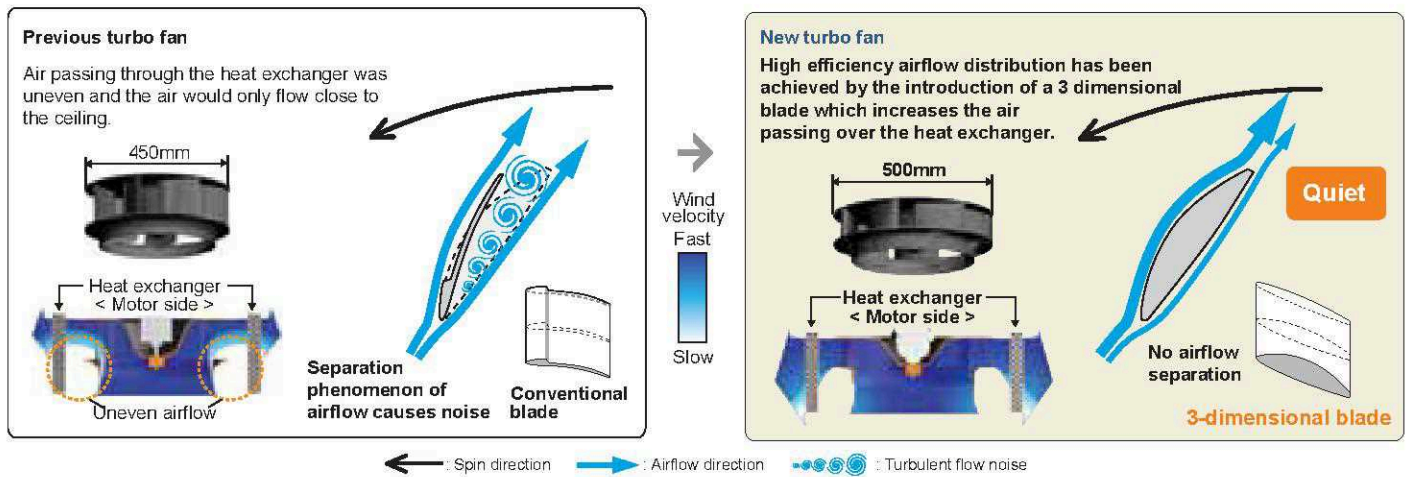

### Specifications

Model name			AUXD18LALH	AUXD24LALH	AUXA30LALH	AUXA36LALH	AUXA45LALH	AUXA54LALH
Power source			230V~50Hz					
Capacity	Cooling	kW	5.6	7.1	9.0	11.2	12.5	14.0
	Heating		6.3	8.0	10.0	12.5	14.0	16.0
Input power		W	16	30	59	80	99	119
Airflow rate	High	m³/h	1,040	1,330	1,600	1,800	1,900	2,000
	Med		940	1,040	1,300	1,300	1,370	1,370
	Low		870	870	1,000	1,000	1,000	1,000
Sound pressure level	High	dB(A)	31	38	40	44	46	47
	Med		28	31	38	38	39	39
	Low		26	26	31	31	31	31
Dimensions (H x W x D)		mm	246 x 840 x 840			288 x 840 x 840		
Weight		kg	23			40		
Connection pipe diameter	Liquid (Flare)	mm	ø9.52					
	Gas (Flare)		ø15.88			ø19.05		
	Drain		ø25 (I.D.) ; ø32 (O.D.)					
Grille (option)	Model name		UTG-UG★A-W					
	Dimensions ( H x W x D )		mm 50 x 950 x 950					
	Weight		kg 5.5					

G★ : GY(FUJITSU) ; GG(GENERAL)

Note : Specifications are based on the following conditions.

Cooling : Indoor temperature of 27°CDB / 19°CWB, and outdoor temperature of 35°CDB / 24°CWB

Heating : Indoor temperature of 20°CDB / (15°CWB), and outdoor temperature of 7°CDB / 6°CWB.

Pipe length : 7.5 m, Height difference between outdoor unit and indoor unit : 0 m.

Voltage : 230 [V].

## Improvement of the airflow distribution

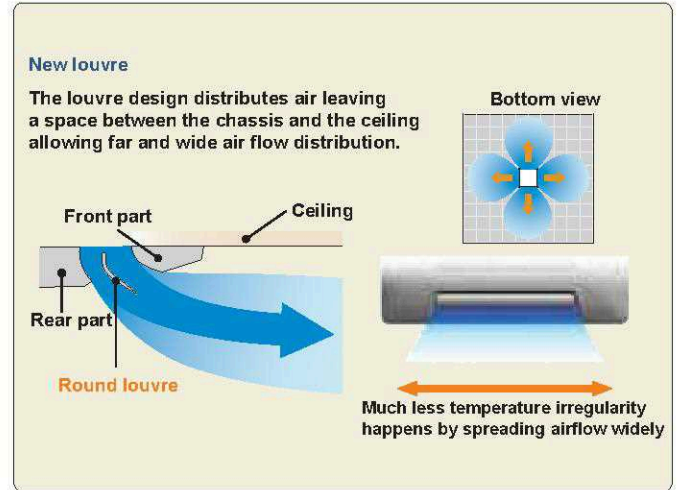
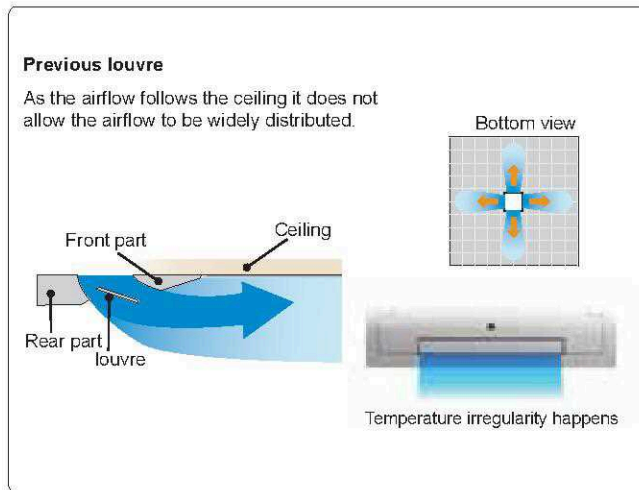

## Adjustment of hanger position is possible after installation

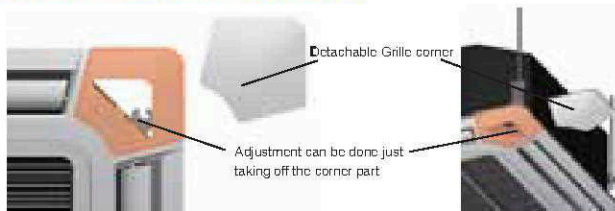

## One way aperture installation

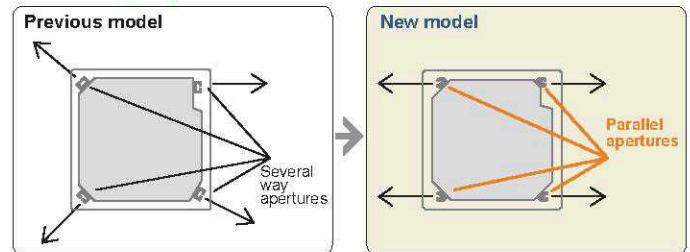

## High lift drain pump



## Optional Parts

- IR Receiver Kit UTY-LRH\*B1
  - Air Outlet Shutter Plate UTR-YDZC
  - Panel Spacer UTG-BGYA-W
  - Wide Panel UTG-AGYA-W
- H\*: HY(FUJITSU); HG(GENERAL)

## Dimensions

Models: AUXD18LALH / AUXD24LALH (Slim type)  
 AUXA30LALH / AUXA36LALH / AUXA45LALH / AUXA54LALH  
 (Unit : mm)  
 ( ) : AUXD18 / AUXD24

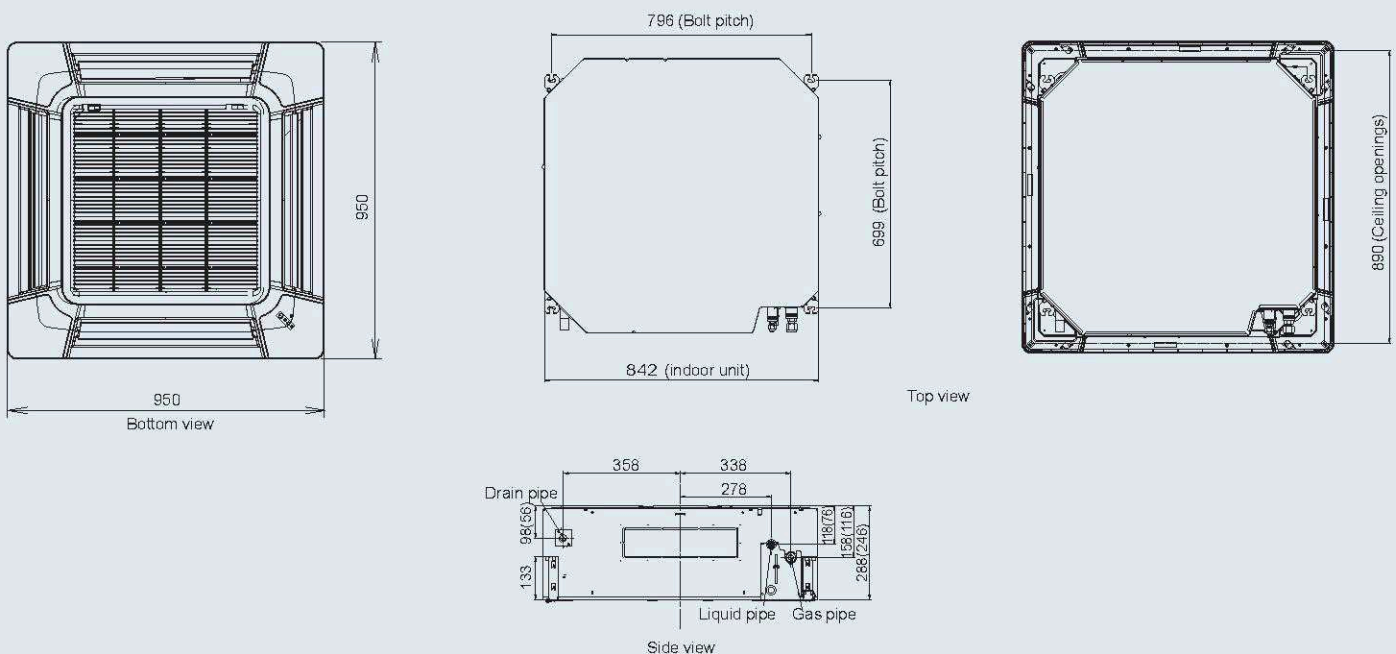

# Compact Duct

Small and compact indoor unit suitable for many applications

Models

**ARXB07LALH**  
**ARXB09LALH**

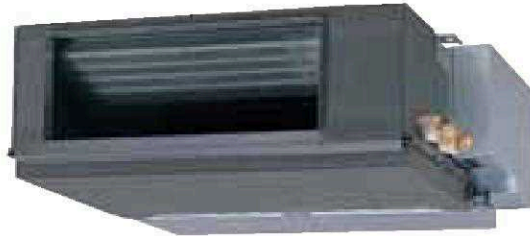

Models

**ARXB12LALH**  
**ARXB14LALH**  
**ARXB18LALH**

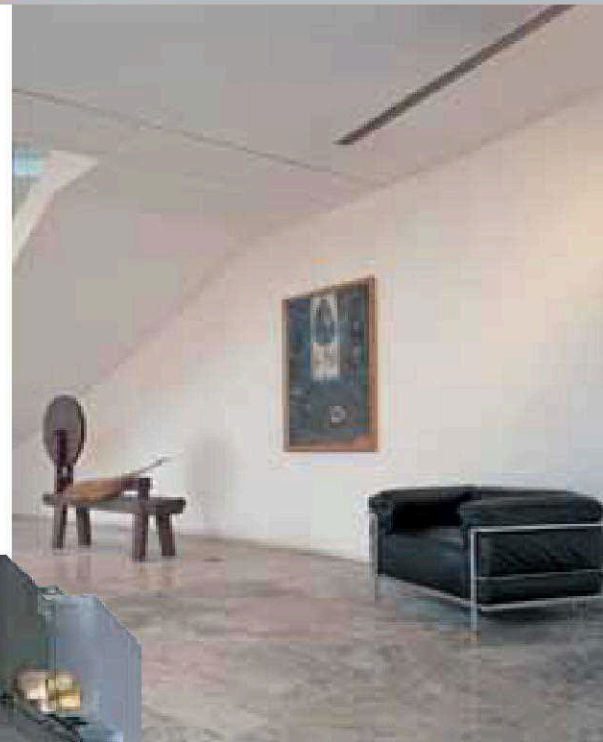

## Low noise level

A low noise level has been achieved for each capacity

Model		7	9	12	14	18
Static pressure (Normal/Max.)	Pa	0 / 50				
Noise level (Low speed)	dB(A)	24	27	25	26	30

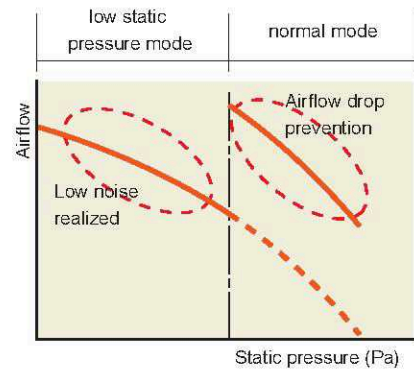

## Specifications

Model name			ARXB07LALH	ARXB09LALH	ARXB12LALH	ARXB14LALH	ARXB18LALH	
Power source			230V ~, 50Hz					
Capacity	Cooling	kW	2.2	2.8	3.6	4.5	5.6	
	Heating		2.8	3.2	4.0	5.0	6.3	
Input power		W	31.2	32.6	55.0	63.0	103.0	
Airflow rate	High	m³/h	330	370	560	610	950	
	Med		300	340	500	550	790	
	Low		270	310	420	470	620	
Static pressure range		Pa	0 to 50	0 to 50	0 to 50	0 to 50	0 to 50	
Sound pressure level	High	dB(A)	29	31	30	31	40	
	Med		27	29	28	29	35	
	Low		24	27	25	26	30	
Dimensions (H x W x D)		mm	217 x 683 x 595			217 x 953 x 595		
Weight		kg	18			25		
Connection pipe diameter	Liquid (Flare)	mm	ø6.35				ø9.52	
	Gas (Flare)		ø12.70				ø15.88	
	Drain		ø25 (I.D.) ; ø32 (O.D.)					

Note : Specifications are based on the following conditions.  
 Cooling : Indoor temperature of 27°CDB / 19°CWB, and outdoor temperature of 35°CDB / 24°CWB.  
 Heating : Indoor temperature of 20°CDB / (15°CWB), and outdoor temperature of 7°CDB / 6°CWB.  
 Pipe length : 7.5 m; Height difference between outdoor unit and indoor unit : 0 m.  
 Voltage : 230 [V]; Standard static pressure : 0 Pa.

## Compact design

Ultra-slim duct air conditioner for easy installation

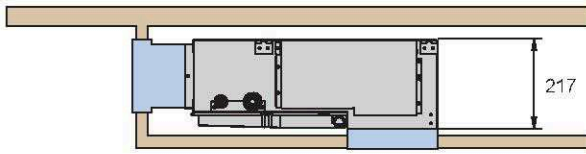

Slim size (217mm) allows installation even where the space behind the ceiling is narrow.

## Two-direction drain piping

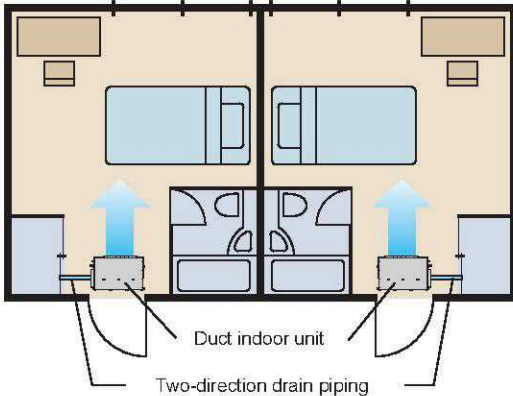

## Air-intake

Air intake direction can be selected to match the installation site.

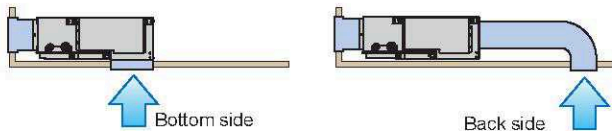

## Flexible installation

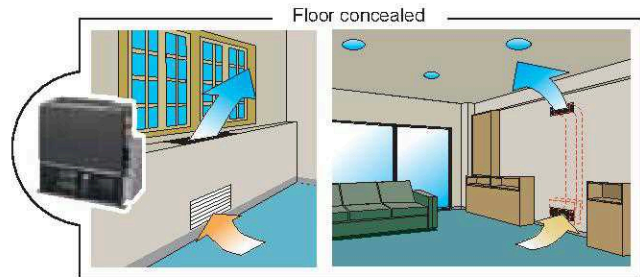

## Filter (Accessory)

ARXB07 / ARXB09

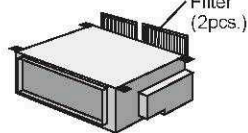

ARXB12 / ARXB14 / ARXB18

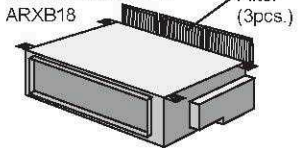

## Optional parts

Remote Sensor Unit UTD-RS100  
IR Receiver Unit UTB-\*WB  
Drain Pump Unit UTZ-PX1BBA  
\*WB : YWB(FUJITSU) , GWB(GENERAL)

## Dimensions

Models: ARXB07 / ARXB09 / ARXB12 / ARXB14 / ARXB18

\*Service accessibility must be allowed for when installing the product.

Please consult the installation manual for the necessary service access size.

(Unit : mm)

( ) : AR7 / AR9

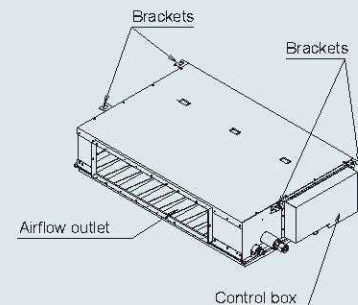
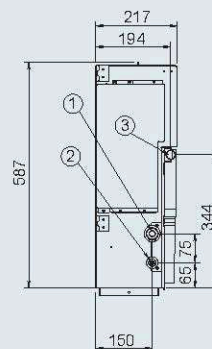
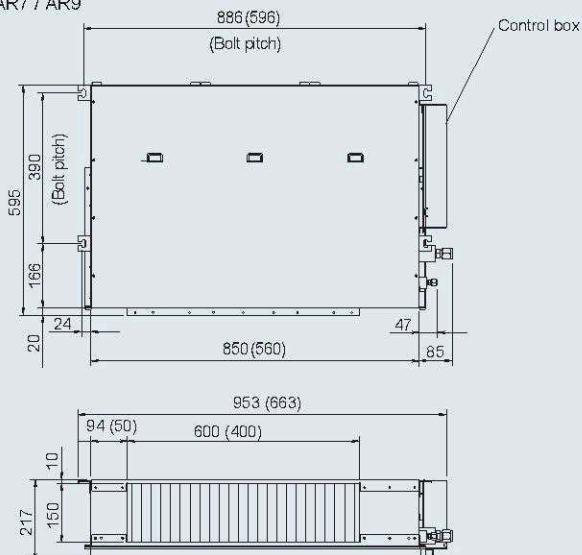

- ① Refrigerant piping flare connection (Gas)
- ② Refrigerant piping flare connection (Liquid)
- ③ Drain piping connection

# Low Static Pressure Duct

Indoor units suitable for quiet rooms such as a hotel or a bedroom

Models

- ARXB24LATH
- ARXB30LATH
- ARXB36LATH
- ARXB45LATH



# Duct

Slim Compact design allows for easy installation in narrow ceiling spaces up to 270mm

Models

- ARXA24LATH
- ARXA30LATH
- ARXA36LATH
- ARXA45LATH

## Slim & Compact design

In the case of bottom return air connection, not only does the indoor unit design allow for installation in a narrow ceiling space of up to 270mm, Further space savings have been achieved by mounting the electrical control box internally inside the chassis.

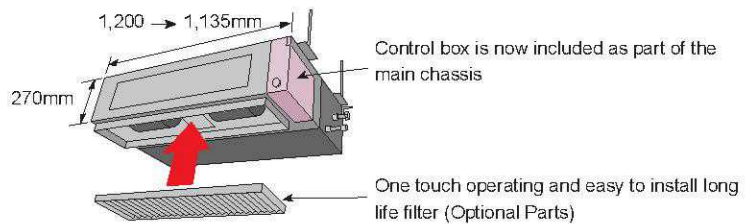

## Specifications

Model name			ARXB24LATH	ARXB30LATH	ARXB36LATH	ARXB45LATH	ARXA24LATH	ARXA30LATH	ARXA36LATH	ARXA45LATH
Power source			230V ~, 50Hz				230V ~, 50Hz			
Capacity	Cooling	kW	7.1	9.0	11.2	12.5	7.1	9.0	11.2	12.5
	Heating		8.0	10.0	12.5	14.0	8.0	10.0	12.5	14.0
Input power		W	155	171	216	246	161	172	220	312
Airflow rate	High	m <sup>3</sup> /h	1,090	1,200	1,440	1,580	1,100	1,400	1,750	1,800
	Med		970	1,090	1,270	1,450	1,000	1,300	1,650	1,600
	Low		870	970	1,160	1,320	900	1,200	1,550	1,500
Static pressure range		Pa	0 to 80	0 to 80	0 to 80	0 to 80	30 to 150	30 to 150	30 to 150	30 to 150
Sound pressure level	High	dB(A)	29	31	35	37	38	40	43	44
	Med		26	28	32	35	36	38	41	42
	Low		24	26	30	33	34	36	39	40
Dimensions (H x W x D)		mm	270x1,135x700				270x1,135x700			
Weight		kg	43			45	43			45
Connection pipe diameter	Liquid (Flare)	mm	ø9.52				ø9.52			
	Gas (Flare)		ø15.88		ø19.05		ø15.88		ø19.05	
	Drain		ø25 (I.D.); ø32 (O.D.)				ø25 (I.D.); ø32 (O.D.)			

Note : Specifications are based on the following conditions.  
 Cooling : Indoor temperature of 27°CDB / 19°CWB, and outdoor temperature of 35°CDB / 24°CWB.  
 Heating : Indoor temperature of 20°CDB / (15°CWB), and outdoor temperature of 7°CDB / 6°CWB.  
 Pipe length : 7.5 m; Height difference between outdoor unit and indoor unit : 0 m.  
 Voltage : 230 [V]; Standard static pressure : 0 Pa (ARXB24LATH, ARXB30LATH, ARXB36LATH, ARXB45LATH)  
 Voltage : 230 [V]; Standard static pressure : 100 Pa (ARXA24LATH, ARXA30LATH, ARXA36LATH, ARXA45LATH)

## Line-up of low-noise and high-power models, compatible with a wide range of static pressure

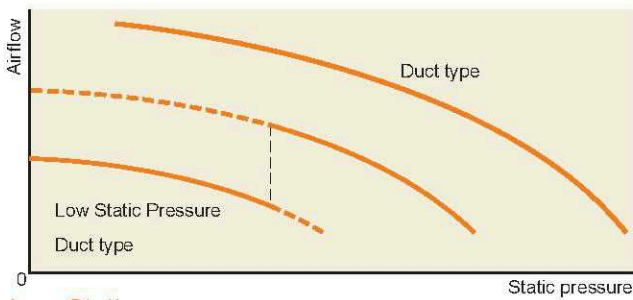

### Low Static Pressure Duct type

Optimum model for hotels or bedrooms

An ultra low-noise model that achieves a quiet interior. Perfect for hotels or bedrooms with limited air duct installation space. Two different levels can be selected according to the static pressure range.

**24dB**

ARXB24  
Low

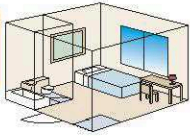

### Duct type

Powerful model with a flexible design

With a powerful motor, appropriate for a wide range of static pressure. Flexible air duct installation is possible in a large space such as an office.

**Max. 150Pa**

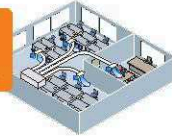

## Two-direction drain piping

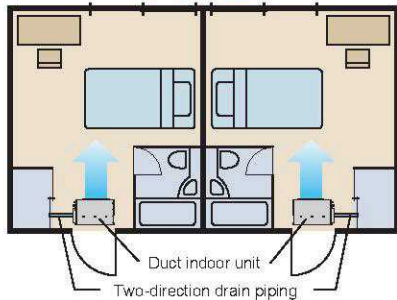

## Easy maintenance

See below for the case of rear suction type

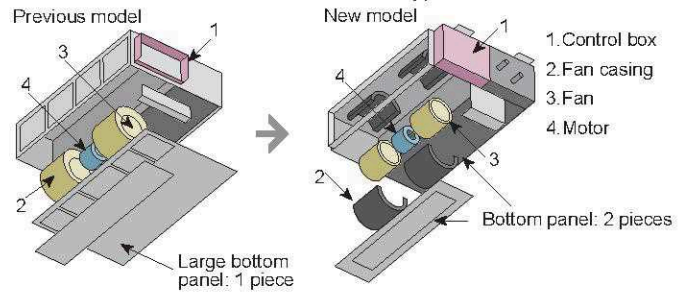

Structural improvement is attained by making the bottom panel two pieces, front and rear. The internal fan casing is also manufactured in two pieces, namely upper and lower. The maintenance of the motor and fan can be easily carried out by removing the rear panel and the lower part of the casing while leaving the main chassis installed.

## Installation styles

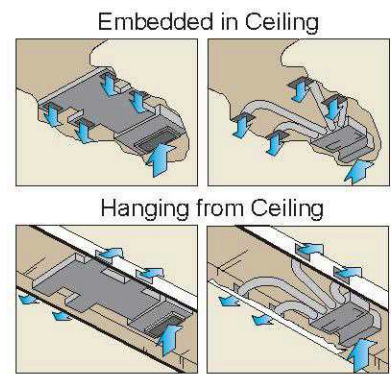

## Optional parts

Remote Sensor Unit	UTD-RS100
Long Life Filter	UTD-LF25NA
Flange (Square)	UTD-SF045T
Flange (Round)	UTD-RF204
IR Receiver Unit	UTB-★WB
Drain Pump Unit	UTZ-PX1NBA
★WB : YWB(FUJITSU) , GWB(GENERAL)	

## Dimensions

Models: ARXB24 / ARXB30 / ARXB36 / ARXB45  
ARXA24 / ARXA30 / ARXA36 / ARXA45

\*Service accessibility must be allowed for when installing the product.

Please consult the installation manual for the necessary service access size.  
(Unit : mm)

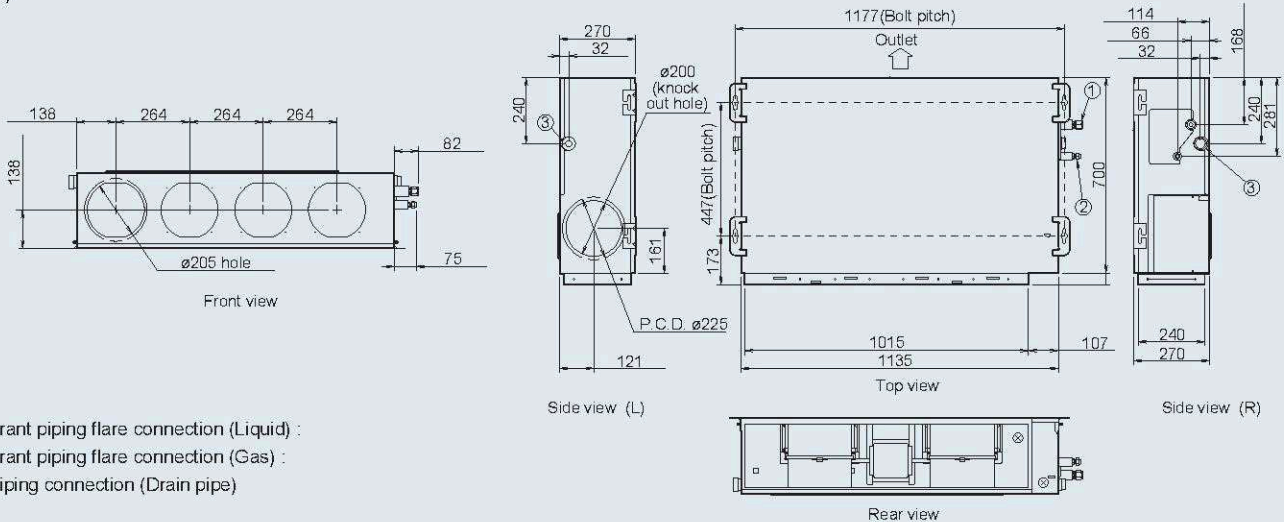

- ① Refrigerant piping flare connection (Liquid) :
- ② Refrigerant piping flare connection (Gas) :
- ③ Drain piping connection (Drain pipe)

# High Static Pressure Duct

These indoor units allow for high airflow quantities

Models

**ARXC36LATH**  
**ARXC45LATH**  
**ARXC60LATH**



Models

**ARXC72LATH**  
**ARXC90LATH**



## Specifications

Model name			ARXC36LATH	ARXC45LATH	ARXC60LATH	ARXC72LATH	ARXC90LATH
Power source			230 V ~, 50Hz				
Capacity	Cooling	kW	11.2	12.5	18.0	22.4	25.0
	Heating		12.5	14.0	20.0	25.0	28.0
Input power		W	405	427	427	1,045	1,250
Airflow rate	High	m³/h	2,600	3,500	3,500	3,700	4,300
	Med		1,950	3,000	3,000	3,200	4,000
	Low		1,450	2,460	2,460	2,900	3,500
Static pressure range		Pa	100 to 200	100 to 250	100 to 250	50 to 300	100 to 300
Sound pressure level	High	dB(A)	45	49	49	51	53
	Med		38	45	45	48	51
	Low		32	42	42	45	49
Dimensions (H x W x D)		mm	400 x 1,050 x 500			450 x 1,550 x 700	
Weight		kg	45		50	82	82
Connection pipe diameter	Liquid	mm	ø9.52 (Flare)			ø12.70 (Brazing)	
	Gas		ø19.05 (Flare)			ø22.22(Brazing)	
	Drain		ø25 (I.D.) ; ø32 (O.D.)				

Note : Specifications are based on the following conditions.

Cooling : Indoor temperature of 27°CDB / 19°CWB, and outdoor temperature of 35°CDB / 24°CWB

Heating : Indoor temperature of 20°CDB / (15°CWB), and outdoor temperature of 7°CDB / 6°CWB

Pipe length : 7.5 m; Height difference between outdoor unit and indoor unit : 0 m.

Voltage : 230 [V]; Standard static pressure : 100 Pa (ARXC36LATH, ARXC45LATH, ARXC60LATH).

Voltage : 230 [V]; Standard static pressure : 200 Pa (ARXC72LATH, ARXC90LATH)

## Easy installation (Compact size & Lightweight)

Models : ARXC36 / ARXC45

A compact size and lightweight indoor unit has been developed by reducing the basic chassis and the overall material weight.

Volume  
**47.5%**  
down

Weight  
**40%**  
down

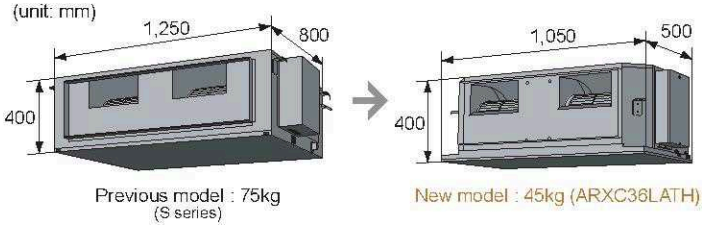

## Low noise

Models : ARXC36 / ARXC45 / ARXC60

Cutting off the corners of the conventional indoor unit front panel and fan casing, has enabled less turbulent air flow. Low noise is realized by adopting a plastic case and a plastic fan.

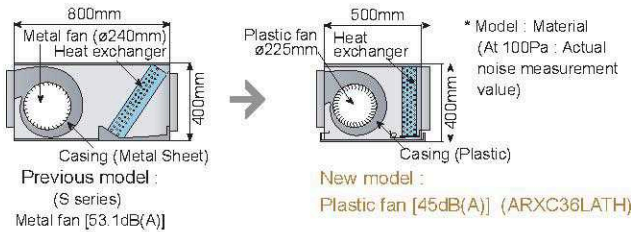
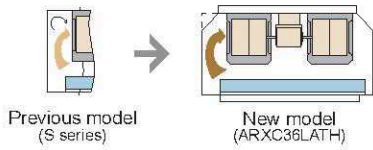

## Static pressure selection : ARXC72/ARXC90

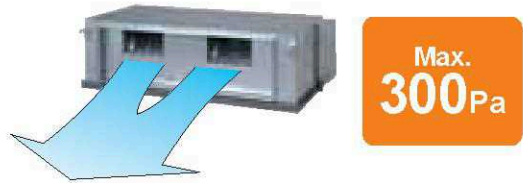

2 Types of static pressure mode are selectable.

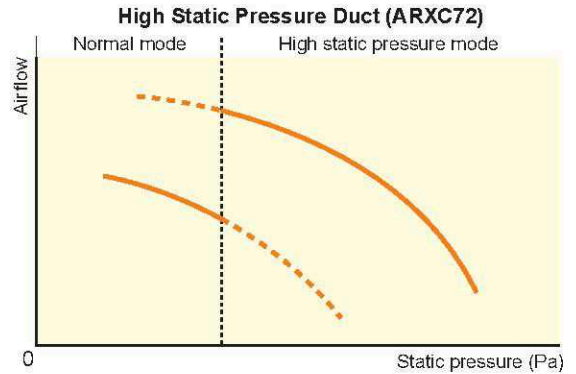

The adoption of a single phase fan motor allows 3 steps fan speed control

## Optional parts

- Long-Life Filter UTD-LF60KA (For ARXC36 / 45 / 60)
- IR Receiver Unit UTB-★WB
- \*WB : YWB(FUJITSU) , GWB(GENERAL)

## Dimensions

Models: ARXC36 / ARXC45 / ARXC60  
(Unit : mm)

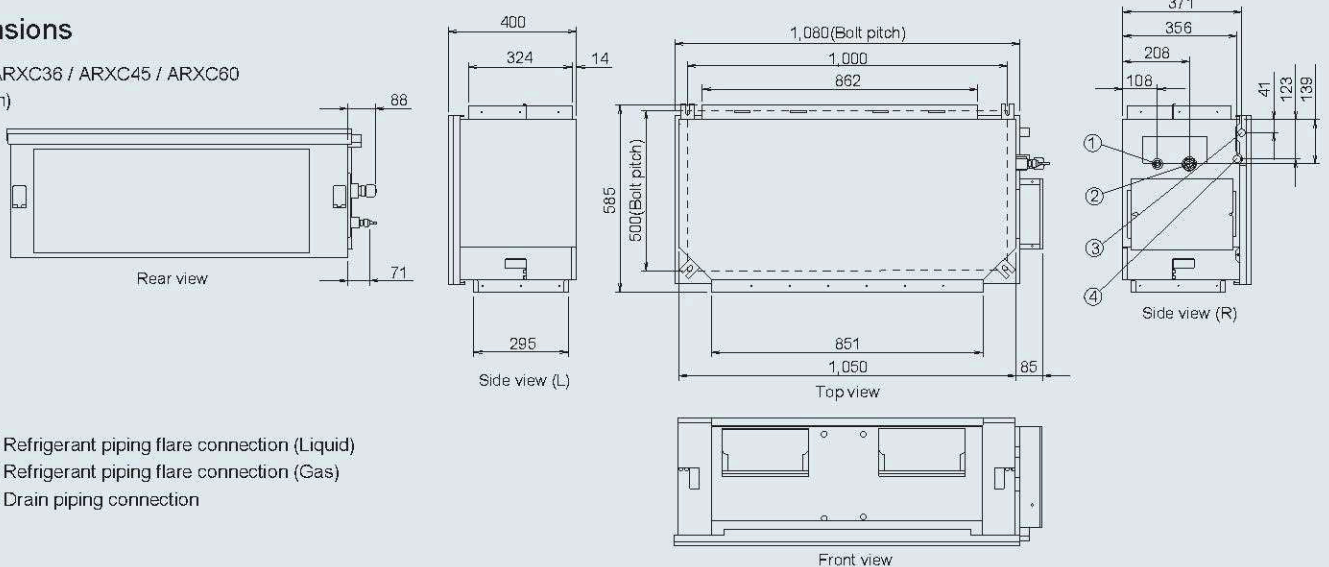

Models: ARXC72 / ARXC90  
(Unit : mm)

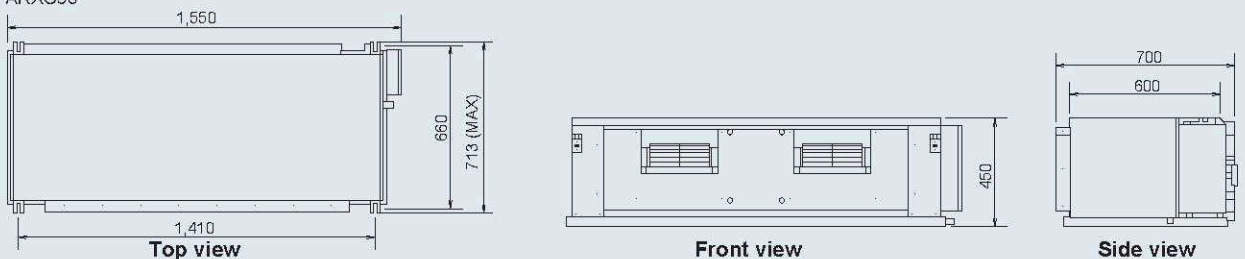

# Floor / Ceiling

The slim and lightweight design allows the unit to be suspended from the ceiling or installed on the floor. This type suits many room designs

## Models

- AB\*A12LATH**
- AB\*A14LATH**
- AB\*A18LATH**
- AB\*A24LATH**



## Flexible installation

Example for floor installation

Floor console



Example for ceiling installation

Under ceiling



## Specifications

Model name			<b>AB*A12LATH</b>	<b>AB*A14LATH</b>	<b>AB*A18LATH</b>	<b>AB*A24LATH</b>
Power source			230V ~, 50Hz			
Capacity	Cooling	kW	3.6	4.0	5.6	7.1
	Heating		4.0	4.5	6.3	8.0
Input power		W	57	57	88	88
Airflow rate	High	m <sup>3</sup> /h	640	640	780	880
	Med		560	560	650	740
	Low		480	480	550	630
Sound pressure level	High	dB(A)	40	40	46	48
	Med		37	37	41.5	44
	Low		34	34	37	40
Dimensions (H x W x D)		mm	199 x 990 x 655			
Weight		kg	28			
Connection pipe diameter	Liquid (Flare)	mm	ø6.35		ø9.52	
	Gas (Flare)		ø12.70		ø15.88	
	Drain		ø25 (I.D.) ; ø32 (O.D.)			

AB\*: ABY(FUJITSU), ABH(GENERAL)

Note : Specifications are based on the following conditions.

Cooling : Indoor temperature of 27°CDB / 19°CWB, and outdoor temperature of 35°CDB / 24°CWB.

Heating : Indoor temperature of 20°CDB / (15°CWB), and outdoor temperature of 7°CDB / 6°CWB.

Pipe length : 7.5 m; Height difference between outdoor unit and indoor unit : 0 m.

Voltage : 230 [V].

## Double auto swing

A combination of up/down and right/left directional swing allows three-dimensional air direction control.

RIGHT and LEFT SWING

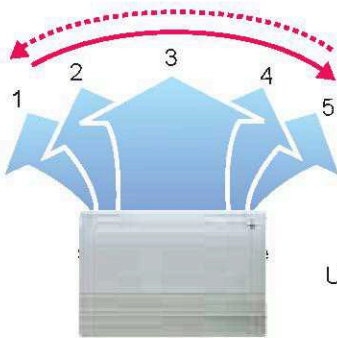

UP and DOWN SWING

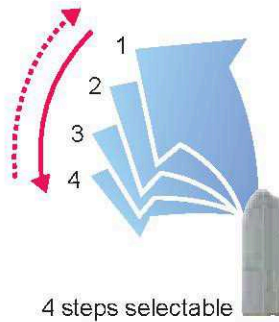

## Super vane

Double Louvre Super vane with newly developed special configuration boosts airflow sending cool air quickly to every corner of the room.

## Auto-closing louvre

When operation is stopped, the louvres will automatically close. (This function is available on all non-ducted models.)

## Compact design

Symmetrical, slim and compact design.

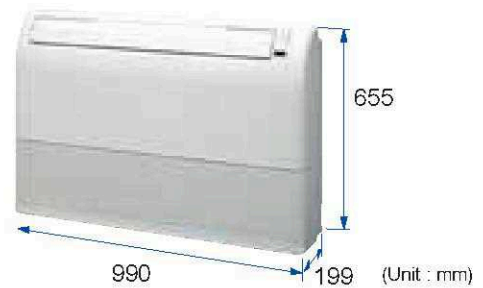

## Dimensions

Models: AB\*A12 / AB\*A14 / AB\*A18 / AB\*A24  
(Unit : mm)

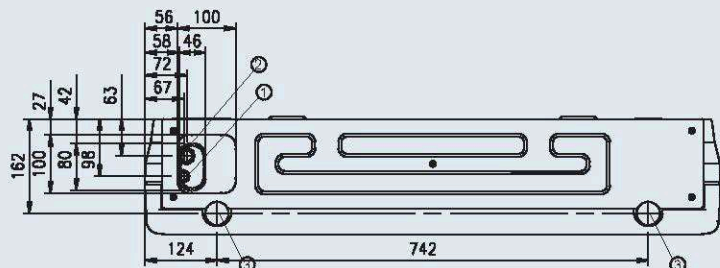
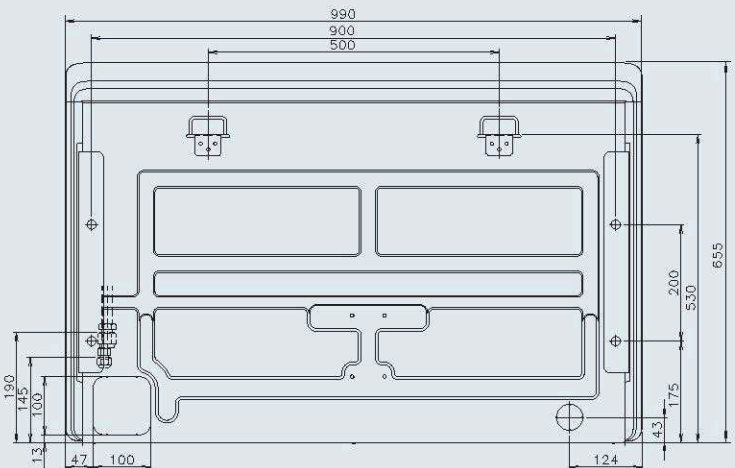
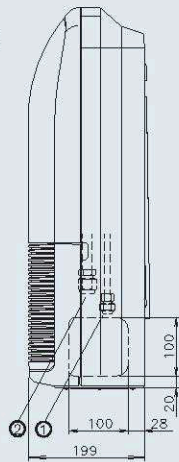

- ① Refrigerant piping flare connection (Liquid)
- ② Refrigerant piping flare connection (Gas)
- ③ Drain piping connection

# Ceiling

Easily concealed in any installation

## Models

- AB\*A30LATH
- AB\*A36LATH
- AB\*A45LATH
- AB\*A54LATH



## Installation

Open

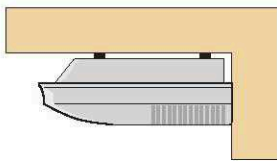

General installation pattern which suspends the indoor unit from the ceiling.

Concealed

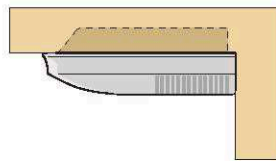

Installation pattern where part of the indoor unit is embedded into the ceiling.

Wall mounted

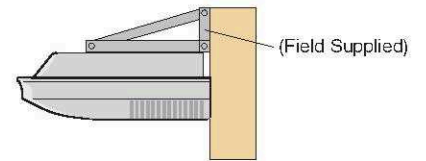

Installation which fixes the indoor unit to the wall by the use of wall brackets (Field supplied). This type of installation can be used when the ceiling space is insufficient.

## Specifications

Model name			AB*A30LATH	AB*A36LATH	AB*A45LATH	AB*A54LATH
Power source			230V ~, 50Hz			
Capacity	Cooling	kW	9.0	11.2	12.5	14.0
	Heating		10.0	12.5	14.0	18.0
Input power		W	124	144	160	180
Airflow rate	High	m <sup>3</sup> /h	1,450	1,660	1,850	2,200
	Med		1,280	1,500	1,660	2,000
	Low		980	1,270	1,430	1,800
Sound pressure level	High	dB(A)	42	45	48	52
	Med		39	42	46	50
	Low		35	37	41	46
Dimensions (H x W x D)		mm	240 x 1,660 x 700			
Weight		kg	48			
Connection		Liquid (Flare)	ø9.52			
pipe diameter	Gas (Flare)	mm	ø15.88	ø19.05		
	Drain		ø25 (I.D.) ; ø32 (O.D.)			

AB\*: ABY(FUJITSU), ABH(GENERAL)

Note : Specifications are based on the following conditions.

Cooling : Indoor temperature of 27°CDB / 19°CWB, and outdoor temperature of 35°CDB / 24°CWB.

Heating : Indoor temperature of 20°CDB / (15°CWB), and outdoor temperature of 7°CDB / 6°CWB.

Pipe length : 7.5 m, Height difference between outdoor unit and indoor unit : 0 m.

Voltage : 230 [V]

## Double auto swing and wide airflow

Auto airflow direction and auto swing

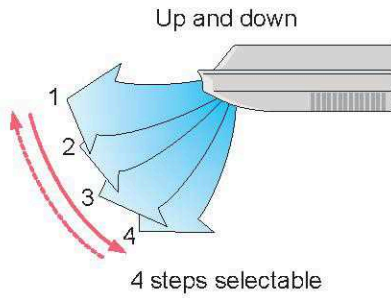
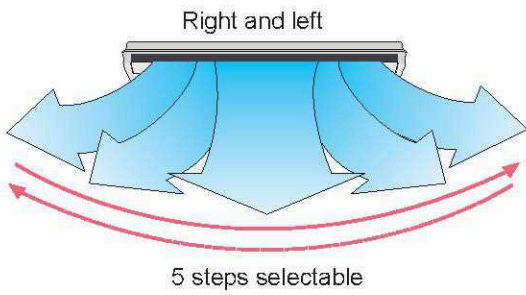

## Long Airflow

Long Airflow ensures comfort to every corner of a large room.

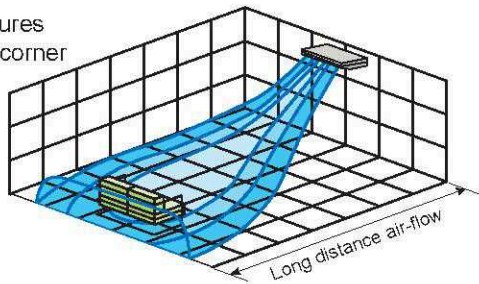

## Slim & Compact design

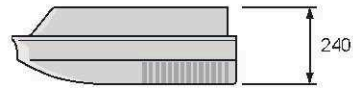

## Condensate lift-up mechanism (Option)

Optional drain lift-up mechanism allows flexible installation.

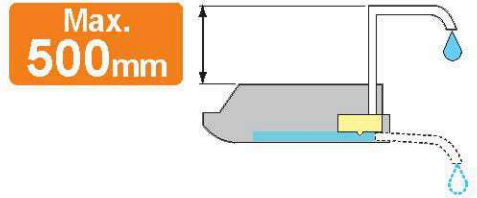

## Fresh air intake

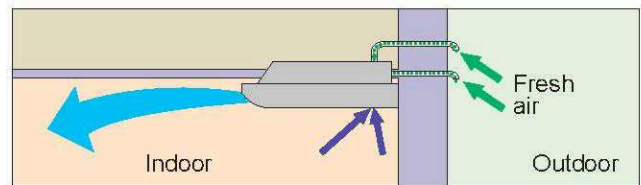

## Long-life filter

High Efficiency long-life filter doubles the life of the filter compared to standard filters.

## Optional parts

Drain Pump Unit UTR-DPB24T

## Dimensions

Models: AB\*A30 / AB\*A36 / AB\*A45 / AB\*A54  
(Unit : mm)

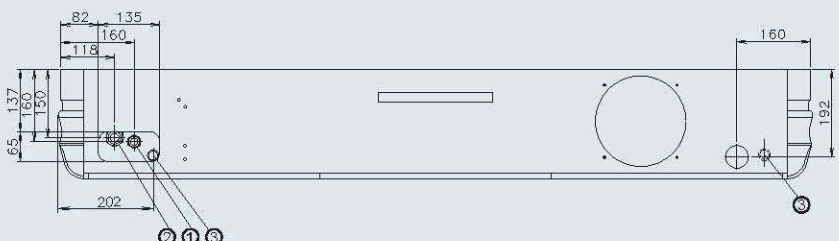
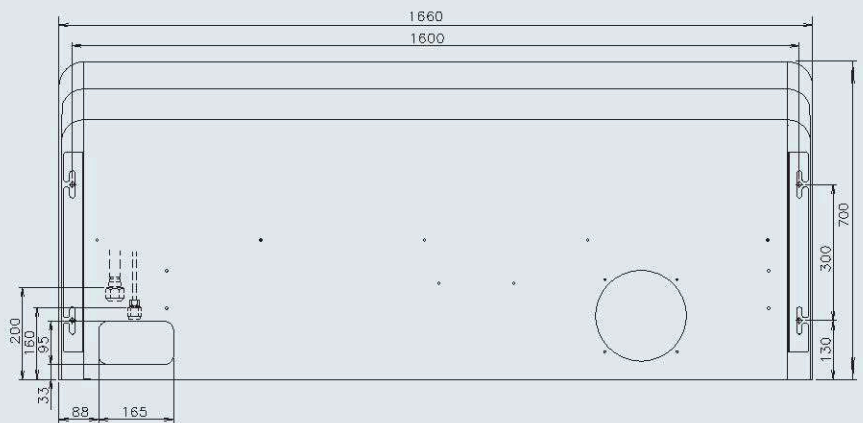

- ① Refrigerant piping flare connection (Liquid)
- ② Refrigerant piping flare connection (Gas)
- ③ Drain piping connection

# Compact Wall Mounted

Compact and Stylish design indoor



## Models

(EEV internal model)	(EEV external model)
<b>AS*A07LACH</b>	<b>AS*E07LACH</b>
<b>AS*A09LACH</b>	<b>AS*E09LACH</b>
<b>AS*A12LACH</b>	<b>AS*E12LACH</b>
<b>AS*A14LACH</b>	<b>AS*E14LACH</b>



## Filter features



### Apple-catechin filter

Fine dust, invisible mold spores, and harmful microorganisms are absorbed onto the filter by static electricity, and further growth is inhibited and deactivated by the polyphenol ingredient extracted from apples.



### Long-life\* Ion deodorization filter

The filter deodorizes by powerfully decomposing absorbed odors using the oxidizing and reducing effects of ions generated by the ultra-fine-particle ceramic.



### Deodorizing effect (Odor reduction rate)

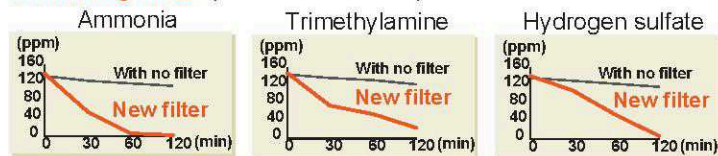

Testing organization : Environmental Sanitary Inspection Center Test method : Deodorization Test

\* The filter can be used for approx. 3 years if it is washed under water to restore its surface action when it is dirty.

## Specifications

Model name			AS*A07LACH	AS*A09LACH	AS*A12LACH	AS*A14LACH	AS*E07LACH	AS*E09LACH	AS*E12LACH	AS*E14LACH
Power source			230V ~, 50Hz				230V ~, 50Hz			
Capacity	Cooling	kW	2.2	2.8	3.6	4.5	2.2	2.8	3.6	4.5
	Heating		2.8	3.2	4.1	5.0	2.8	3.2	4.1	5.0
Input power		W	16	16	19	21	15	16	20	23
Airflow rate	High	m <sup>3</sup> /h	490	500	560	620	490	500	560	680
	Med		450	450	480	490	450	450	480	490
	Low		370	370	420	420	370	370	420	420
Sound pressure level	High	dB(A)	34	35	38	43	34	35	38	43
	Med		32	32	34	35	32	32	34	35
	Low		26	26	30	30	26	26	30	30
Dimensions (H x W x D)		mm	275 x 790 x 215				275 x 790 x 215			
Weight		kg	9				9			
Connection pipe diameter	Liquid (Flare)	mm	ø6.35				ø6.35			
	Gas (Flare)		ø12.70				ø12.70			
	Drain		ø13.8(I.D.) ; ø15.8-ø16.7(O.D.)				ø13.8(I.D.) ; ø15.8-ø16.7(O.D.)			
EV Kit (option)			-				UTR-EV09XB		UTR-EV14XB	

AS\*: ASY(FUJITSU), ASH(GENERAL)

Note : Specifications are based on the following conditions.

Cooling : Indoor temperature of 27°CDB / 19°CWB, and outdoor temperature of 35°CDB / 24°CWB.

Heating : Indoor temperature of 20°CDB / (15°CWB), and outdoor temperature of 7°CDB / 6°CWB.

Pipe length : 7.5 m; Height difference between outdoor unit and indoor unit : 0 m.

Voltage : 230 [V]

## Low noise

**26dB**

(AS07/09)

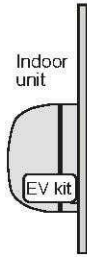

Electronic Expansion valves are built-in allowing for easy installation.

For installation to places that require additional low noise, select the external electronic expansion valve type.

## Compact size

Powerful output even compact design

Though the indoor unit is compact, it features a large, high pressure cross fan (90mm diameter) in a centre mounted configuration and a Lambda type heat exchanger to provide plenty of power.

**Width 790mm**

## Symmetrical design

Symmetrical, clean design that suits all interiors.



## New Style High Power DC fan motor

- High power
- Wide rotation range
- High efficiency
- Compact size



## Auto swing louvre

The Auto Swing Louvre function ensures that the air direction corresponds to the mode selected.

Cooling : 2-step (① - ②)<sup>\*1</sup>  
Heating : 4-step (① - ④)

→ Step  
→ Swing

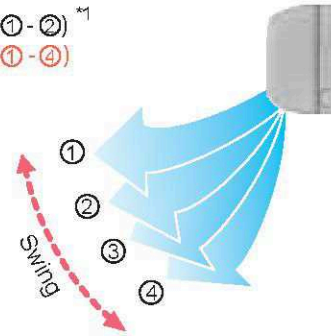

\*1 When doing 3-4 louvre-setting positions in cooling operation, it returns to the 2 louvre-setting position automatically 30 minutes later.

## Easy maintenance

Easy maintenance has been realized as the front panel can be removed for easy access.



## Wired control compatible



Wired and Wireless Remote Controller are acceptable.



Wired Remote Controller



Simple Remote Controller

## Dimensions

Models: AS\*A07 / AS\*A09 / AS\*A12 / AS\*A14  
AS\*E07 / AS\*E09 / AS\*E12 / AS\*E14

(Unit : mm)

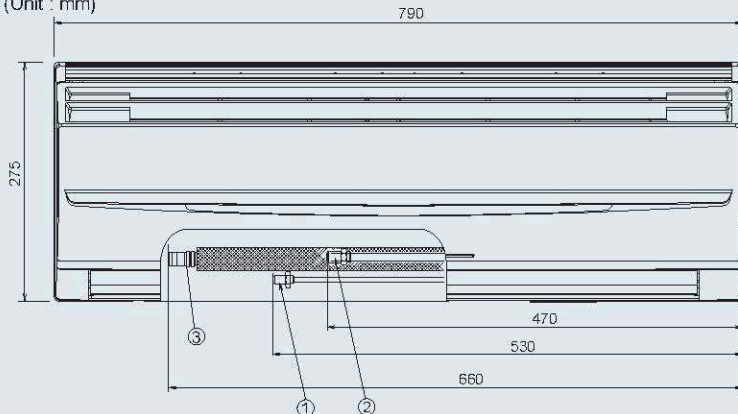

- ① Refrigerant pipe flare connection (Liquid)
- ② Refrigerant pipe flare connection (Gas)
- ③ Drain piping connection

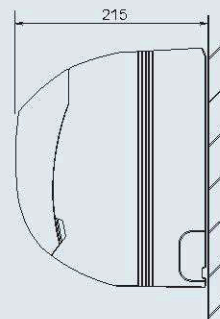

EV kit (UTR-EV09XB/ UTR-EV14XB) Optional parts:

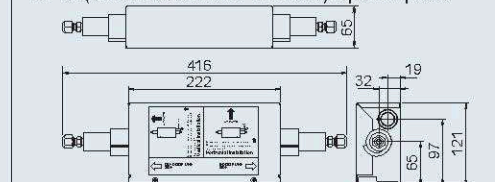

# Wall Mounted

Double auto swing louver provides pleasant air flow to every corner of the room

Models

- AS\*A18LATH
- AS\*A24LATH
- AS\*A30LATH

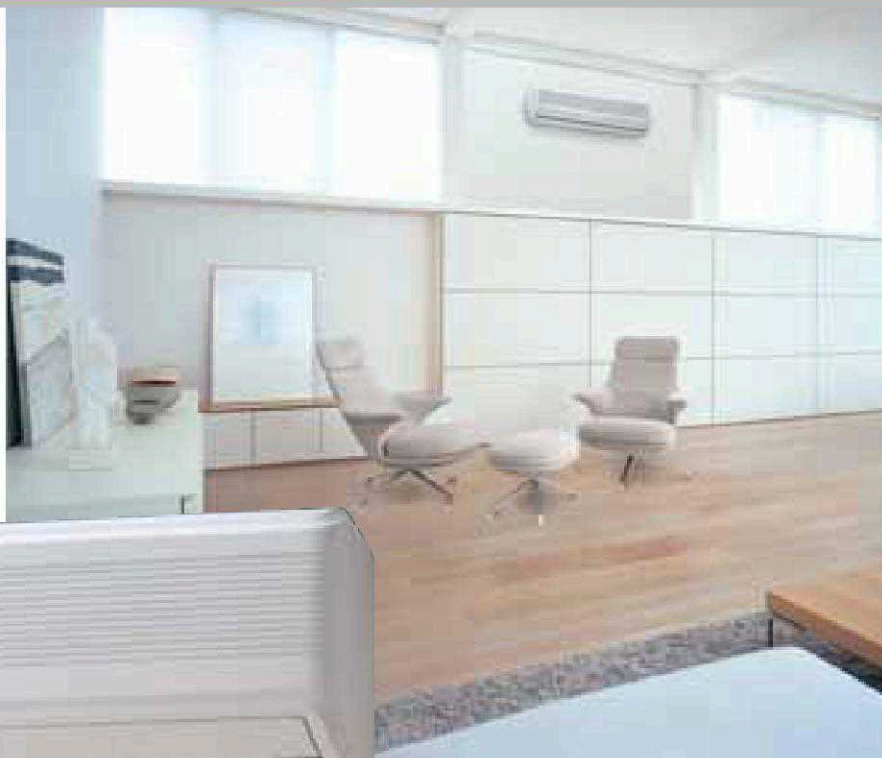

## Powerful output in spite of small size

Though the indoor unit is compact, it features a large, high pressure cross fan (107mm diameter) in a center mounted configuration and a lambda type heat exchanger to provide plenty of power. The extra long diffuser provides a wide outflow opening for air. This ensures a large air outflow volume over a wide area to cool or heat all areas of the room.



## Specifications

Model name			AS*A18LATH	AS*A24LATH	AS*A30LATH
Power source			230V ~, 50Hz		
Capacity	Cooling	kW	5.6	7.1	8.0
	Heating		6.3	8.0	8.8
Input power		W	38	50	60
Airflow rate	High	m <sup>3</sup> /h	800	970	1,040
	Med		650	870	910
	Low		550	750	730
Sound pressure level	High	dB(A)	41	45	47.5
	Med		36.5	41	44
	Low		33	37	39.5
Dimensions (H x W x D)		mm	320 x 1,120 x 220		
Weight		kg	16		
Connection pipe diameter	Liquid (Flare)	mm	ø9.52		
	Gas (Flare)		ø15.88		
	Drain		ø12 (I.D.) ; ø16 (O.D.)		

AS\*: ASY(FUJITSU), ASH(GENERAL)

Note : Specifications are based on the following conditions.

Cooling : Indoor temperature of 27°CDB / 19°CWB, and outdoor temperature of 35°CDB / 24°CWB

Heating : Indoor temperature of 20°CDB / (15°CWB), and outdoor temperature of 7°CDB / 6°CWB

Pipe length : 7.5 m, Height difference between outdoor unit and indoor unit : 0 m.

Voltage : 230 [V]

## Multi airflow

Large independently driven power diffuser used

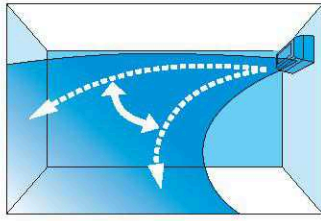

Horizontal concentration and other air direction control

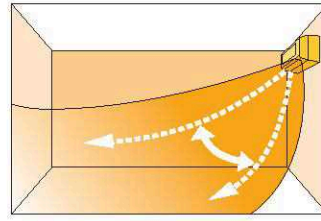

Wide down flow

➡ Steps  
➡ Swing

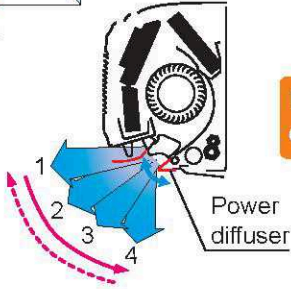

Large independently driven power diffuser

➡ Steps  
➡ Swing

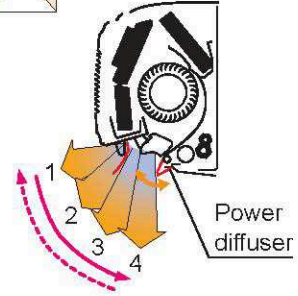

## Low noise

- High efficiency fan construction ➔ ø7mm Lambda type evaporator improves the airflow path
- Large independently driven power diffuser

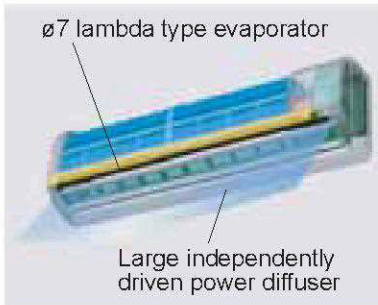

Low noise  
**33dB**  
(AS18)

## Easy installation

Expanded work space at bottom of casing increases piping space by 15%.

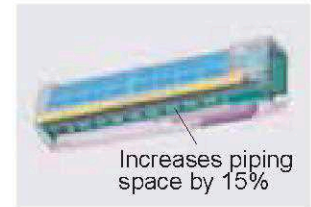

## Others

- Double auto swing
- 2-way draining route

## Dimensions

Models: AS\*A18 / AS\*A24 / AS\*A30  
(Unit : mm)

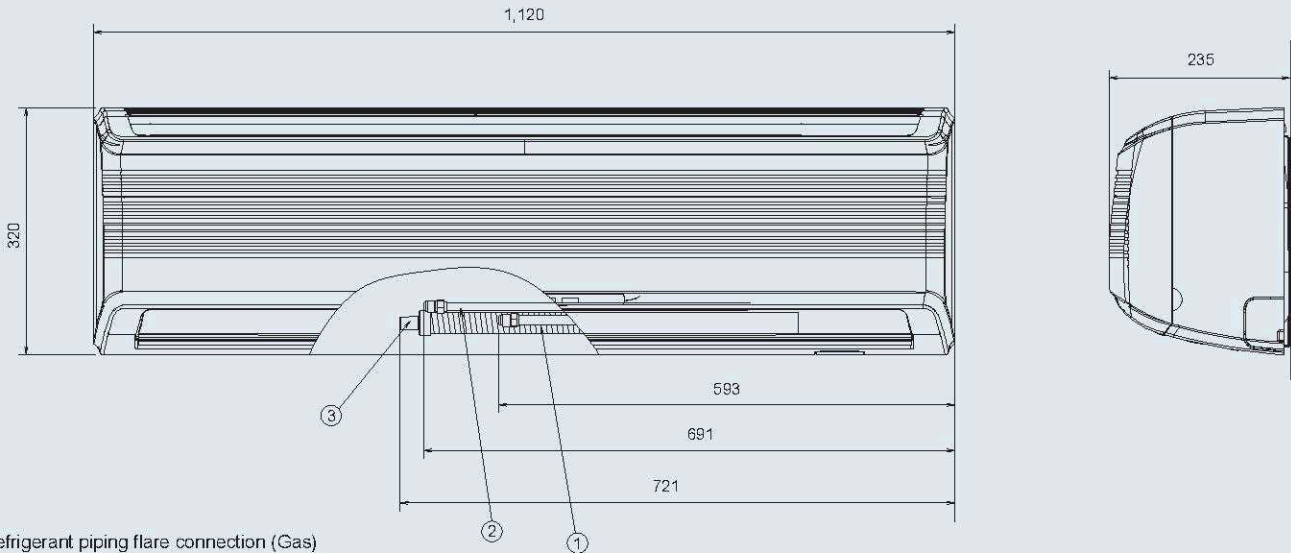

- ① Refrigerant piping flare connection (Gas)
- ② Refrigerant piping flare connection (Liquid)
- ③ Drain piping connection

# Control System

The V-II system supports every users needs by offering a variety of Control systems, including individual control, central control and building management control options.

## System Diagram

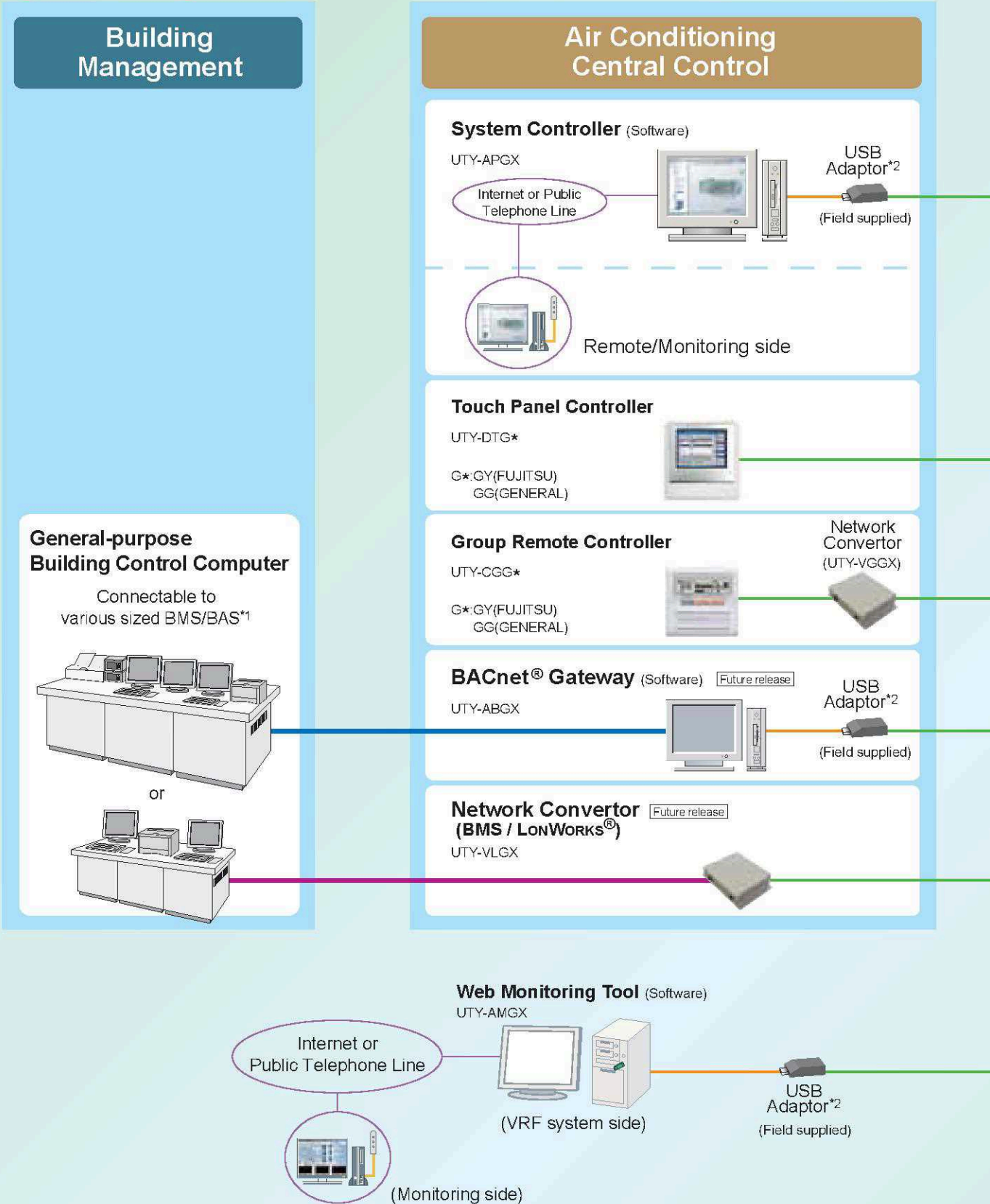

\*1. BMS/BAS: Building Management System / Building Automation System  
 \*2. USB Adaptor is U10 USB Network Interface of Echelon® Corporation.

The device above cannot be connected to the S or V series. (Except System Controller)

## Air Conditioning Individual Control

### Wired Remote Controller

UTY-RNK\*

K\*:KY(FUJITSU),KYT(FUJITSU)  
KG(GENERAL)



### Simple Remote Controller

UTY-RSK\*

K\*:KY(FUJITSU),KYT(FUJITSU)  
KG(GENERAL)



### Simple Remote Controller

UTY-RHK\*

K\*:KY(FUJITSU),KYT(FUJITSU)  
KG(GENERAL)



### Wireless Remote Controller

UTY-LNH\*

H\*:HY(FUJITSU)  
HG(GENERAL)



### Card-key

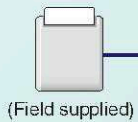

### External Switch Controller

UTY-TEKX



### Service Tool (Software)

UTY-ASGX



## System

Outdoor unit



Indoor unit

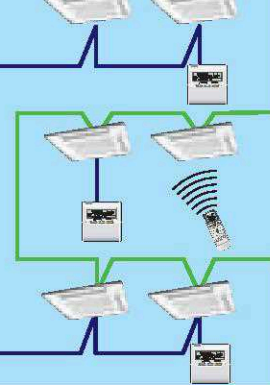

### Signal Amplifier

UTY-VSGX

UTY-VSGX

### IR Receiver Unit

UTB-\*WB

\*W:YW(FUJITSU)  
GW(GENERAL)



### IR Receiver Kit

UTY-LRH\*B1

\*B:YB(FUJITSU)  
GB(GENERAL)



### For single split

### Network Converter

UTY-VGGX



- Transmission line (VRF Network)
- Module link
- Remote controller line
- USB cable
- LONWORKS Network
- Ethernet
- Signal line(Single split system)
- Group Remote Controller line

# Wiring System

Wiring construction of the control system is made of power source wiring, transmission wiring and remote controller wiring.  
 Total wiring length (total length of transmission line) can be extended up to 3,600m (by using signal amplifiers).

Max. Connectable <b>100</b> outdoor units	Max. Connectable <b>400</b> indoor units	Max. Transmission line length <b>3,600m</b>
---	--	--

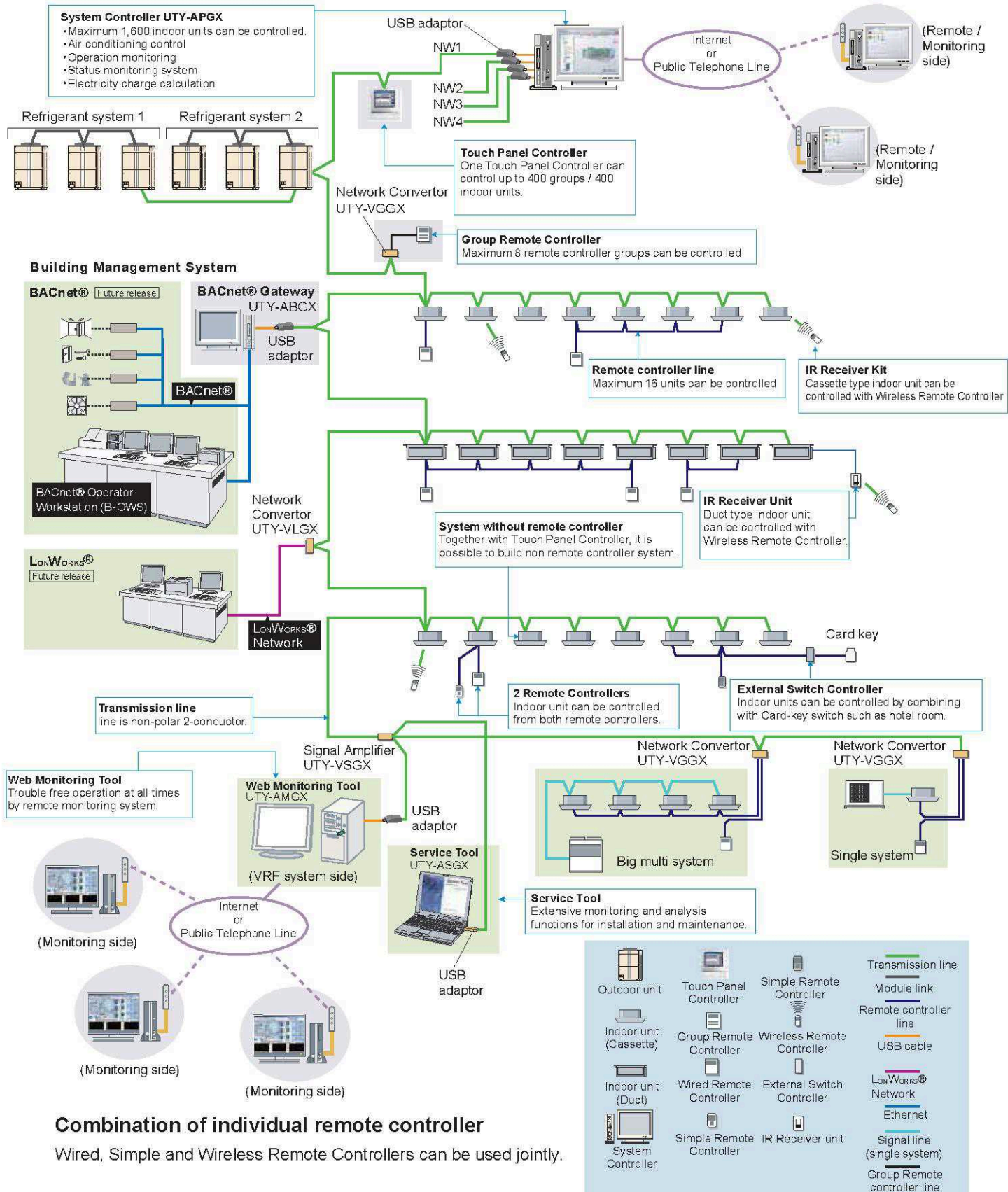

## Combination of individual remote controller

Wired, Simple and Wireless Remote Controllers can be used jointly.

# Comparison table of Controllers

Item	Wired Remote Controller	Simple Remote Controller	Simple <sup>1</sup> Remote Controller	Wireless Remote Controller	Group Remote Controller	Touch Panel Controller	System Controller (Software)
Model name	UTY-RNKY UTY-RHKYT UTY-RNKG	UTY-RSKY UTY-RSKYT UTY-RSKG	UTY-RHKY UTY-RHKYT UTY-RHKG	UTY-LNHY UTY-LNHG	UTY-CGGY UTY-CGGG	UTY-DTGY UTY-DTGG	UTY-APGX
Max. controllable remote controller groups	1	1	1	1	8	400	1600
Max. controllable indoor units	16	16	16	16	96	400	1600
Max. controllable groups	-	-	-	-	-	400	1600
Air conditioning control function	On / Off	●	●	●	●	●	●
	Operating mode setting	●	●	-	●	●	●
	Fan speed setting	●	●	●	●	●	●
	Room temp. setting	●	●	●	●	●	●
	Room temp. set point limitation	-	-	-	-	●	●
	Test operation	●	●	-	●	-	-
	Up/down air direction flap setting	●	-	-	●	-	●
	Right/left air direction flap setting	●	-	-	●	-	●
	Group setting	-	-	-	-	-	●
	RC prohibition	-	-	-	-	-	●
Anti freeze setting	-	-	-	-	-	●	
Display	Failure	●	●	●	-	●	●
	Defrosting	●	●	●	-	●	●
	Current time	●	-	-	●	●	●
	Day of week	●	-	-	-	●	●
	R.C. prohibition	●	●	●	-	-	●
	Cooling/heating priority	●	●	●	-	●	●
	Address display	●	●	●	-	●	●
Timer	System schedule timer	-	-	-	-	●	●
	On/off per day	-	-	-	-	20	72
	On/off per week	-	-	-	-	140	504
	Weekly timer	●	-	-	-	-	-
	On/off per day	2	-	-	-	2	-
	On/off per week	14	-	-	-	14	-
	On/off timer	●	-	-	●	-	-
	Sleep timer	-	-	-	●	-	-
	Program timer	-	-	-	●	-	-
	Day off	●	-	-	-	-	●
Min. unit of timer setting(Minutes)	30	-	-	5	10	10	
Control	Status monitoring system	-	-	-	-	●	●
	Electricity charge calculation	-	-	-	-	-	●
	Error history	●	●	●	-	●	●
	Emergency stop	-	-	-	-	-	● <sup>*2</sup>
	Control via internet	-	-	-	-	-	●
	E-mail notification for malfunction	-	-	-	-	-	●

\*1 "Master control" setting is not available for this model.

\*2 This function is available only through external input. control.

# Wired Remote Controller

## UTY-RNK\*

The room temperature can be controlled by detecting the temperature accurately from the built-in sensor

Max. controllable  
**16**  
indoor units



- Simple operation with Built-in Weekly / Daily Timer.
- Control up to 16 indoor units.
- Up to 2 wired remote controllers can be connected to a single indoor unit.

## Functions

### Powerful features and compact size

This Wired Remote Controller incorporates four primary functions into a single unit.



### Accurate and comfortable

Indoor temperature can be detected accurately by the inclusion of a thermo sensor in the body of the wired controller.

This new wired remote controller and the optional remote sensor allows flexibility in sensor location, suitable for all requirements.

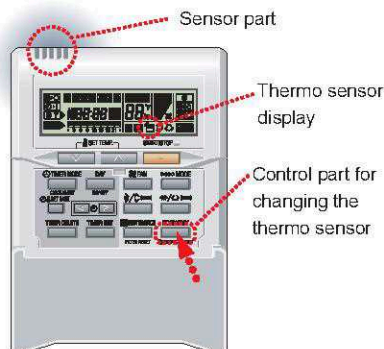

### Example of changing sensor

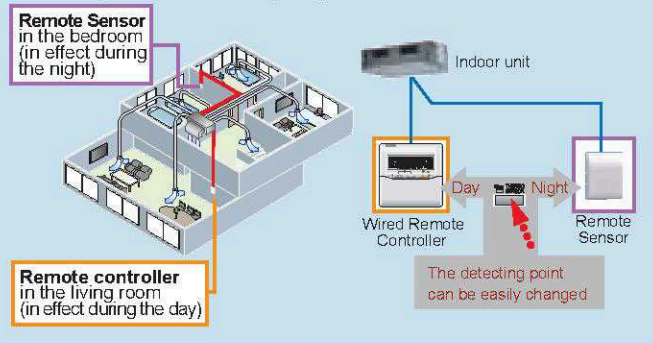

Displayed temperature is set temperature.

## Built-in timers

### Weekly timer :

Possible to set ON/OFF time to operate twice each day of the week.

Easy-to-understand time bar display



Setup screen example (Set to Wednesday: 8:00 to 20:00.)



### Setback timer :

Possible to set temperature for two times spans and for each day of the week.



Setup screen example (Set from Sunday to Saturday: 12:00 to 15:00, 28°C.)

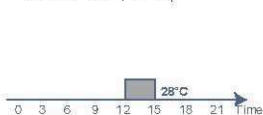

### At "Weekly timer" + "Set back timer" setup



## Diagnosis check function

Two methods are available for determining the cause of failure in the event of a malfunction occurs:

- Malfunction diagnosis function
- Error history (Last 16 error codes can be accessed)

## Simple installation

Components are compatible with standard switch boxes. Flat back surface allows to be installed wherever it is needed.

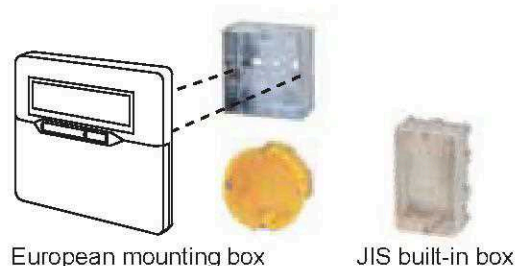

## Specifications

Model name	UTY-RNK*
Power Supply	DC 12V
Dimensions (H x W x D) (mm)	120 x 120 x 17
Weight (g)	160

DC12V is supplied by the indoor unit

K\* : KY(FUJITSU), KYT(FUJITSU), KG(GENERAL)

# Simple Remote Controller

## UTY-RSK\*

## UTY-RHK\* (Without master control)

Compact remote controller provides access to basic functions

- Up to 16 indoor units can be controlled with one remote controller.
- Suitable for hotels or offices as it is easily operated with no complex functions.

Max. controllable  
**16**  
indoor units



UTY-RSK\*



UTY-RHK\*  
Without master control

## Functions

### User-friendly operation

- Provides access to basic operations, such as Start / Stop, Fan control, Master control switching, and Room temperature setting.
- A large On / Off button is provided in the centre of the remote controller for easy operation.
- Can be used jointly with other individual control unit.
- Following an error display, diagnostics can be carried out on the controller.

### Background light

- Background light enables easy operation in a darkened room.
- Background light activates during all button operations, and lasts 10 seconds in operating mode and 5 seconds in stop mode after a button is pressed.



### Simple installation

Can be mounted on the European Mounting Box (Installation dimension: 60mm) or the JIS Built-in Box (Installation dimension: 83.5mm).

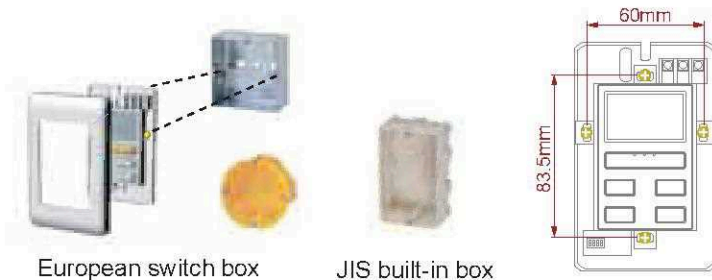

## Functions

Model	UTY-RSK*	UTY-RHK*
Operation		
On / Off	●	●
Fan control	●	●
Master control	●	—*1
Room temp. setting	●	●

\*1: "Master control" setting is not available.

It is recommend to use together with other type controller.

## Specifications

Model name	UTY-RSK*	UTY-RHK*
Power Supply	DC 12V	
Dimensions (H x W x D) (mm)	120 x 75 x 14	
Weight (g)	90 (100 : UTY-RSKYT)	90 (100 : UTY-RHKYT)

DC12V is supplied by the indoor unit

K\* : KY(FUJITSU), KYT(FUJITSU), KG(GENERAL)

# Wireless Remote Controller

## UTY-LNH\*

Simple and sophisticated operations with a choice of 4 daily timers

- A single controller controls up to 16 indoor units.

Max. controllable  
**16**  
indoor units

Selectable  
**4**  
daily timers



## Functions

### Built-in daily timer

Select from 4 different timer programs : On / Off / Program / Sleep

Program timer : The program timer operates the ON and OFF timer once within a 24 hour period.

Sleep timer : The sleep timer function automatically corrects the set temperature according to the time setting to prevent excessive cooling or heating during sleep hours.

### Cooling operation/dry operation

When the sleep timer is set, the set temperature automatically rises 1°C every hour. The set temperature can rise up to a maximum of 2°C.

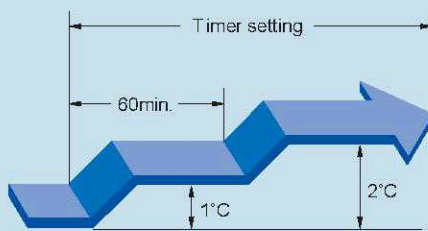

### Heating operation

When the sleep timer is set, the set temperature automatically drops 1°C every 30 minutes. The set temperature can drop to a max. of 4°C.

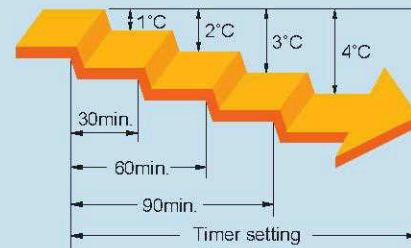

## Easy installation and operation

- Code selector switch prevents indoor unit mix-up. (Up to 4 codes can be set)

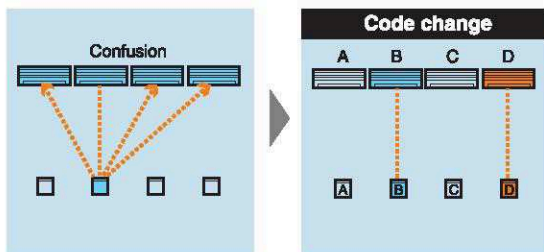

- Wide and precise transmitting range.

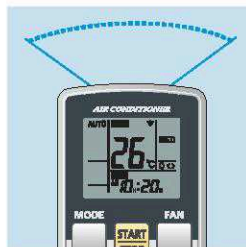

## System addressing

- During installation work, system addressing can be performed using the Wireless Remote Controller, thus eliminating manual switch setting.

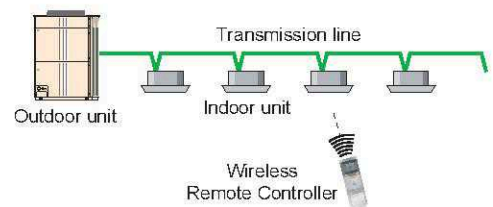

## Specifications

Model name	<b>UTY-LNH*</b>
Battery	1.5V (R03 / LR03 / AAA) x 2
Dimensions (H x W x D) (mm)	158 x 56 x 20
Weight (g)	70

H\* : HY(FUJITSU), HQ(GENERAL)

# IR Receiver Unit

## UTB-\*WB

Necessary to control for all duct type by Wireless Remote Controller



### Wiring connection

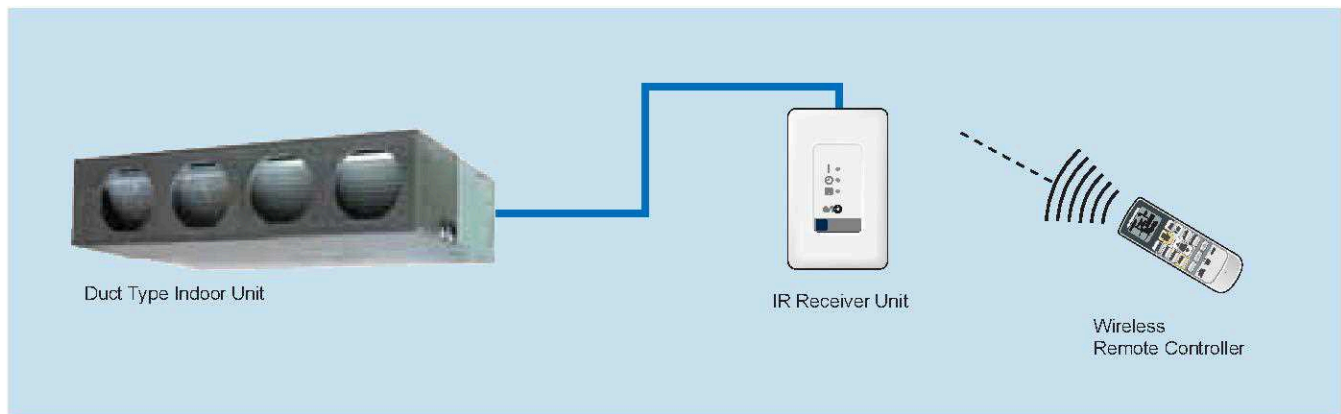

### Specifications

Model name	<b>UTB-*WB</b>
Dimensions (H x W x D) (mm)	122 x 60 x 26.5
Weight (g)	150

\*WB : YWB(FUJITSU), GWB(GENERAL)

# IR Receiver Kit

## UTY-LRH\*B1

Cassette type indoor unit can be controlled with Wireless Remote Controller



### Specifications

Model name	<b>UTY-LRH*B1</b>
Dimensions (H x W x D) (mm)	213.8 x 213.8 x 25.7
Weight (g)	140

H\* : HY(FUJITSU), HG(GENERAL)

# Group Remote Controller

UTY-CGG\*

Max. controllable  
**8**  
remote controller groups

Max. connectable  
**64**  
group R.C. in  
a VRF network system



Group control of indoor units with simple operation

- Up to 8 remote controller groups can be controlled by one Group Remote Controller.
- Up to 64 Group Remote Controllers can be connected in one VRF network system.
- Network Converter (UTY-VGGX) is required to connect Group Remote Controllers to a VRF network system.

## Functions

### High performance and compact size

ON / OFF, Operating mode, Room temperature and Fan speed setting can be controlled / monitored centrally or individually.



### Control up to 8 remote controller groups

•Single Group Remote Controller controls and monitors up to 8 remote controller groups.

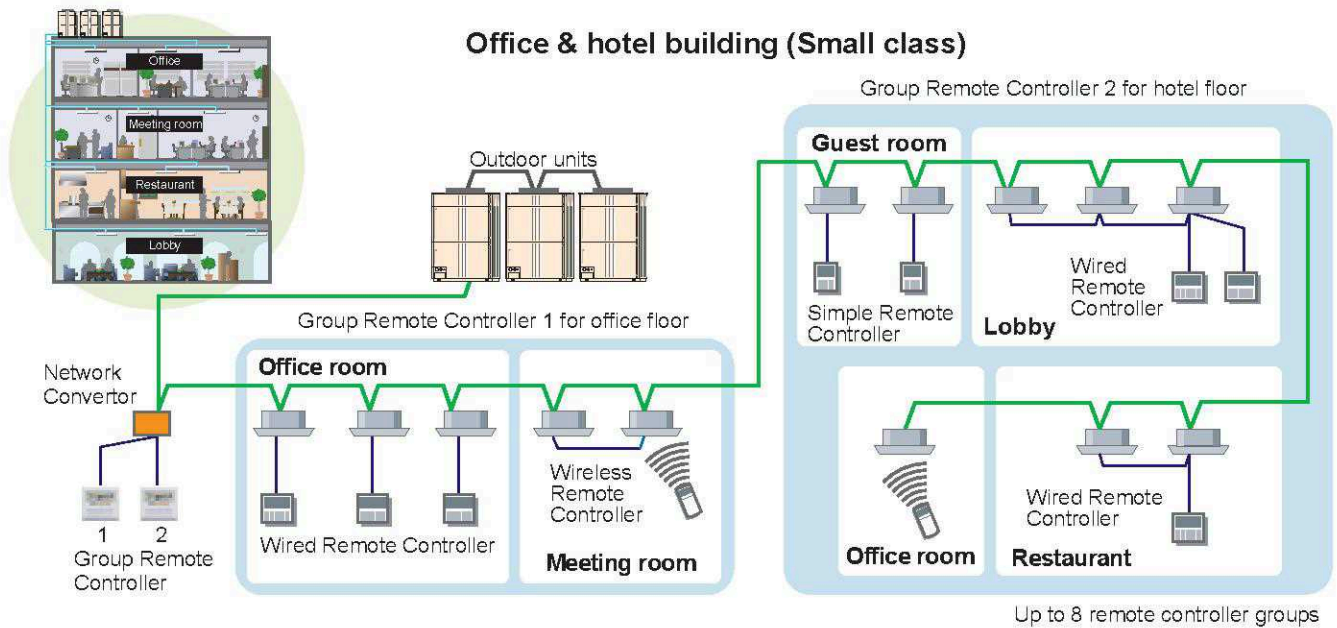

### Built-in weekly timers

The weekly timer is provided as a standard function.

1. The timer can be set up for up to 4 times per day. (On / Off, operating mode, set temperature)
2. Allows separate settings for each day of the week.

#### ON / OFF switching

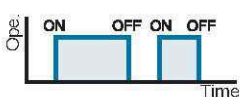

Air conditioning ON/OFF setting corresponding to air conditioning specification needs is possible.

#### Cooling / Heating switching

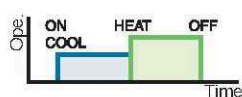

Switching between the cooling mode and heating mode can be set by time.

#### Temperature switching (Peak power cut)

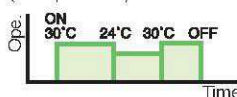

Since peak power cut is performed in a planned way, setting which changes the room temperature linked with time is possible.

#### Temperature switching (Anti-freeze)

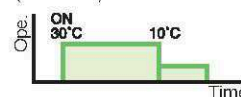

Low temperature heating operation can be set to prevent freezing in cold regions at night, etc.

#### Stop setting

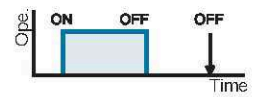

Indoor unit stop setting at operation end time is possible.

## Useful functions

**1** Timer setting at all the connected indoor units is possible by centralized timer on the front panel.

**ALL TIMER Button**  
Press the ALL TIMER button to turn the timer operation on or off for all indoor units.

**3** The indoor unit can be quickly turned on and off by ON / OFF button of each indoor unit on the front of the door.

**Indoor Unit Name Labels**  
Write the names of the indoor units on the included labels and attach them.

**ON / OFF Button**  
Press the ON / OFF button to turn the corresponding indoor unit on or off.

**With cover closed**

**Indoor Unit Operation Indicators**  
Timer setting at all the connected indoor units is possible by centralized timer on the front panel.

- On
- Timer operation
- Off
- ▼ Selection

**2** All the connected indoor units can be turned on / off simultaneously by centralized ON/OFF button on the front of the cover.

**Operation Lamp**  
This is on if any of the indoor units is operating. This flashes if any of the indoor units has malfunction(s).

**ALL OFF Button**  
Press the ALL OFF button to turn off all of the indoor units.

**ALL ON Button**  
Press the ALL ON button to turn on all of the indoor units.

**With cover open**

**Timer and Clock Display and setting**

- Setting Display
- Day Display
- Timer and Clock Display
- Timer Mode Display
- Timer Mode (DELETE) Button
- DAY Button
- Set Time Button
- PROGRAM (CLOCK ADJUST) Button
- ENTER Button

**Displaying the Status and Controlling indoor units**

- Transmission Display
- Operation Lock Display
- ON / OFF Display
- Fan Speed Display
- Set Temperature Display
- Operation Mode Display
- ON / OFF Button
- Select Button
- Fan Control Button
- Master Control Button (\*1, \*2, \*3)
- Set Temperature Button
- Child Lock Function

\*1 : "AUTO" is not available for a heat pump model unless it is set up for the master indoor unit.

\*2 : "FAN" is not available for a heat pump model

\*3 : "HEAT" is not available for a cooling only model

## Specifications

Model name	UTY-CGG*
Power Supply	DC 12V
Dimensions (H x W x D) (mm)	120 x 120 x 17
Weight (g)	200

DC12V is supplied by a network converter.

# Touch Panel Controller

UTY-DTG\*

7.5 inch screen

High visibility and easy operation via high resolution 7.5 inch TFT-LCD touch panel screen

Stylish design

Stylish shape and design to suit all applications

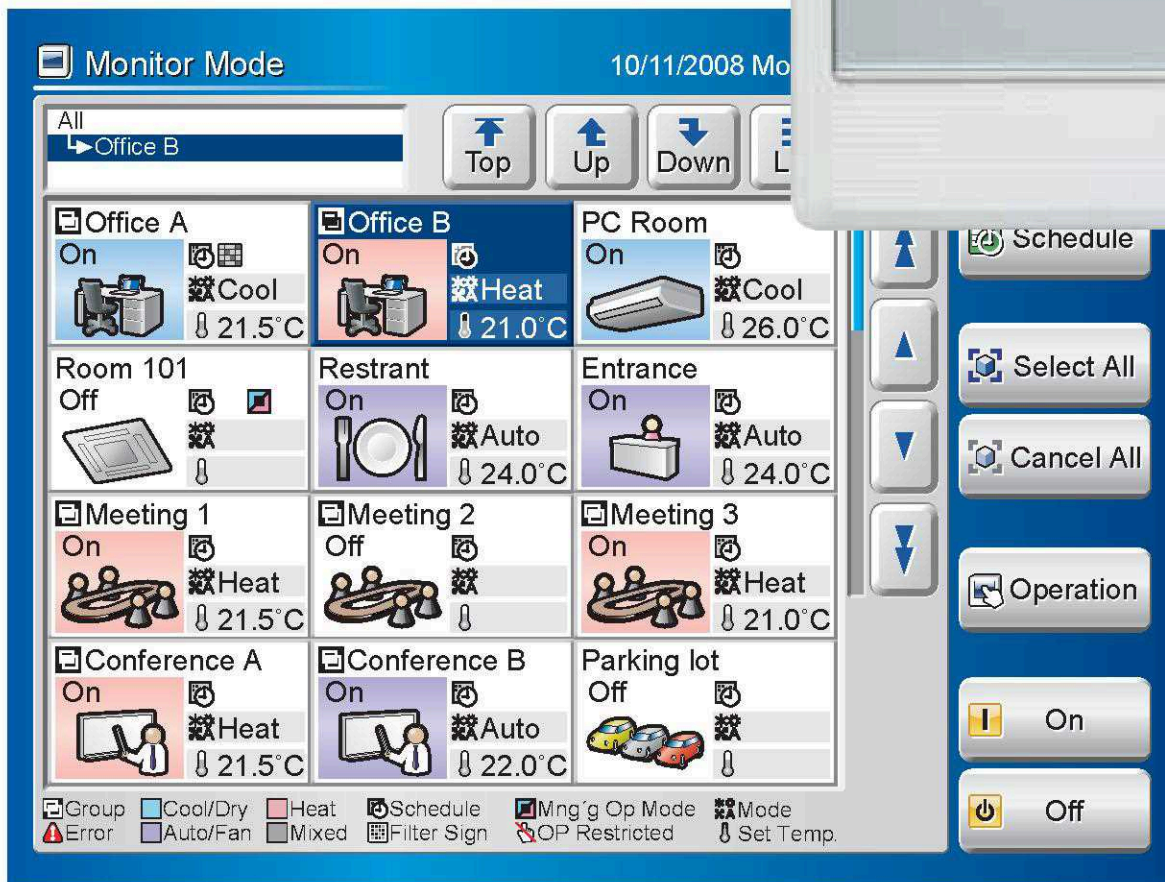

Real size screen image

## Easy operation

- Large and wide-angled LCD is easily viewable even at a distance
- Easy-to-understand icon-driven Graphical User Interface (GUI)
- Wide range of simple-to-understand icons
- Operation can be selected using your finger or the dedicated touch pen by pressing the appropriate on-screen icon
- Up-to-date status display
- Background color identifies current control operation  
Blue for monitoring, green for operational control



## Easy maintenance

- Flat touch screen is easily cleaned
- Non-glare coating on touch panel controller minimizes fingerprint marking
- Easy-to-remove front cover



## Up to 400 indoor units can be controlled

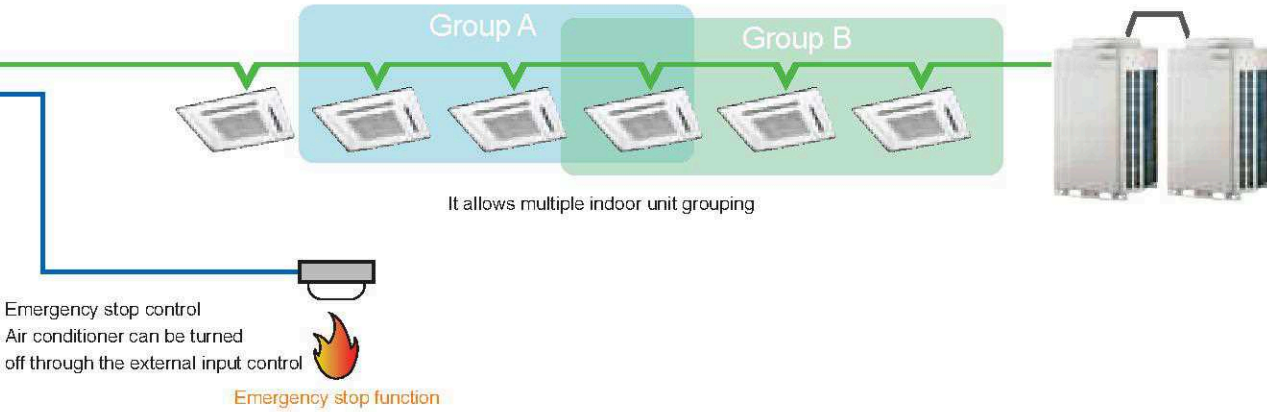

## Versatility

Data transfer available by USB



- CSV format data edited by PC can be imported to Touch Panel Controller.

## Function

- Up to 400 indoor units can be controlled
- It allows multiple indoor units grouping
- Schedule timer function is standard(20 patterns per day)
- Emergency stop function(through the external input control)
- Temperature upper and lower limit setting
- The clock of each indoor unit correct setting



Individual control



Flexible grouping



Schedule control



Indoor units operation monitoring

## Easy installation

Touch Panel Controller is easily mounted to the wall  
Flat back surface allows to be installed wherever it is needed.

- Correctable mechanism for tilting (horizontal) after the installation of the body

No additional component is required for installation

- There is no need for the installation space of power supply adaptor and transmission adaptor etc.



## Specifications

Model name	<b>UTY-DTG*</b>
Power Supply	100-240V 50/60Hz
Dimensions (H x W x D) (mm)	260 x 246 x 54
Weight (g)	2,150
Interface	USB 2.0

# System Controller

Software

## UTY-APGX

Max. controllable  
**4**  
VRF system

Max. controllable  
**400**  
outdoor units

Max. controllable  
**1,600**  
indoor units



This system realizes the advanced general monitoring & control of VRF system from small scale buildings to large scale buildings.

- Up to a maximum of 4 network systems, 1600 indoor units, and 400 outdoor units can be controlled.
- Supports VRF S series, V series and V-II series.
- In addition to air conditioning precision control function, central remote control, electricity charge calculation, schedule management, and energy saving functions are strengthened and building manager and owner needs are met.

### Functions

#### Remote centralized control

By using client software, one PC can perform central control and web control of 10 VRF system sites with max. 20 buildings per site.

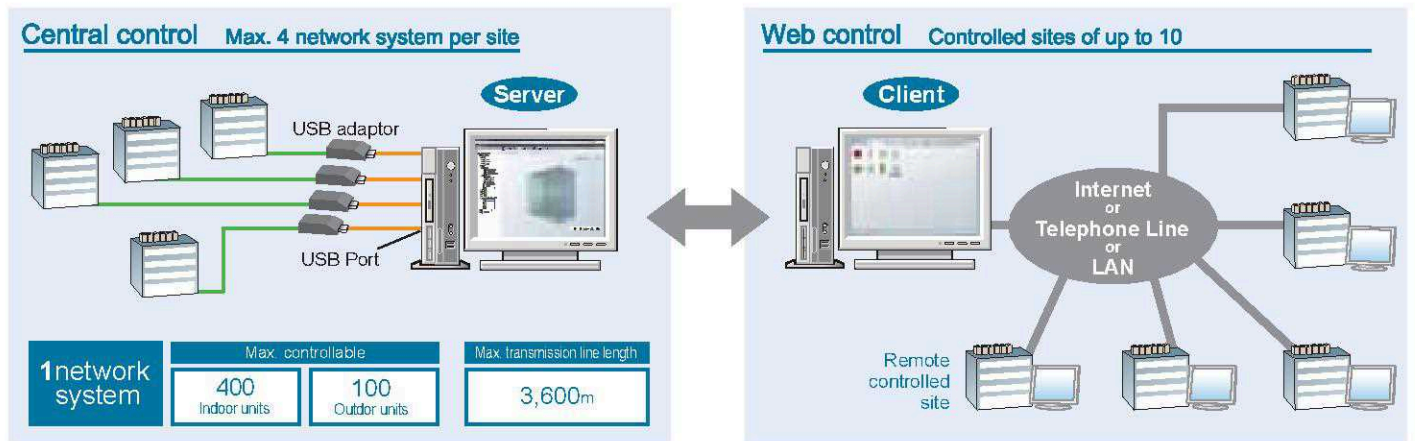

#### User friendly view and operation

**Monitoring located site**

Monitor mode (Site)

**Main operation monitoring screen**

Monitor mode (Building)

**Air conditioning control**

Operation setting

**Operation monitoring of each site**

Monitor mode (Floor)

**Management functions**

Schedule setting

**Monitor mode (List)**

Monitor mode (List)

- Provides graphical view of units layout as site, building and floor layout just as they are located in the actual sites.
- Unit status may be monitored at a glance, selecting the appropriate view that just fit your purpose.
- Control may also be performed from various views as individual unit or as a whole site, building or a whole floor.
- User defined groups, that are neatly arrange as tree view, easy to find, monitor and operate.

## Electricity charge calculation

- Total electricity charge, billed for multiple indoor units connected to the charge meter for air conditioning, is apportioned according to the accumulated operation time and indoor unit capacity.
- Allows accounting for special rates (e.g., for night or weekend use).
- Calculations can be printed as final bills format.

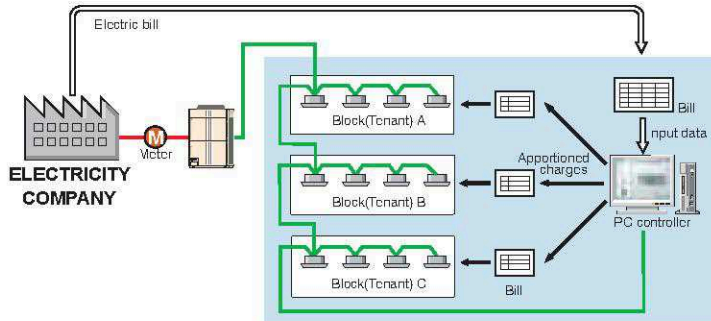

Note: This electrical power apportioning calculation is not official.  
When issued to the user as a bill, it must be explained to the user in advance.

## Schedule control

- Annual schedules can be set for each remote controller group / user defined group.
- Start / stop, operating mode, remote controller prohibition, and temperature settings can be recorded up to 143 times per day at 10 minute intervals for up to 101 configurations for each remote controller group.
- Settings can be made for periods straddling midnight.
- Allows programming of special settings for holidays, including public holidays, for a complete year.

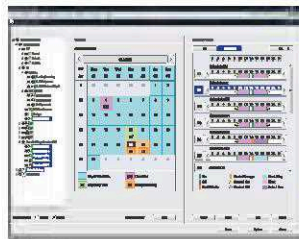

Schedule Control

## Error display

Error is notified with popup message, audible sound and e-mail real time when error occurs. Error for the past 1 year are logged and can be reviewed later.



## Operating & control record

Displays the history of operation status and control.



Operation Record

## Diverse control of indoor units

- Indoor unit operation state, operation mode, etc. are displayed
- Indoor unit start/stop and operation mode switching
- Temperature setting, Remote Controller prohibition.



## Energy saving function

Energy saving operation considering comfort by economy setting, upper/lower limit temperature setting, etc.



## OPERATING CONDITIONS

The following chart shows the detail requirement for an AT compatible personal computer to run System Controller.  
Applies for both server and client software.

Personal Computer	AT compatible machine that runs Microsoft® Windows®
Operating System	Microsoft® Windows® Vista Home Premium, Business, Ultimate Edition Microsoft® Windows® XP Professional with Service Pack2 or later
CPU	Intel® Pentium® / Celeron 2GHz (Server), 1GHz (Client) or higher
HDD	20GB (Server), 5GB (Client) or more of free space
Memory	1GB (Vista) , 512MB (XP) or more
Display	1024 x 768 dots or more. 15 inch or higher size is preferable.
Interface	USB port is required for each of the followings; -Wibu Key (Software protection key) - Echelon® U10 USB Network Interface (Required for each VRF Network) Ethernet port is required for remote connection using internet.
Other Software Required	Adobe® Acrobat® reader 4.0 or later
Accelerator	Requires the internal graphics accelerator be compatible with Microsoft® DirectX® 9.0 or later.

### <PACKING LIST>

Item	Q'ty	Application
CD-ROM	1	Includes the software for System Controller. Both server and client software is included.
Wibu Key (Software protection key)	1	Software protection key to be inserted in a USB slot running System Controller. System Controller may only run on a PC with Wibu Key. Remote client software does not require Wibu Key.

Personal computer must be field supplied.  
U10 USB Network Interface must be field supplied. Contact EchelonR Corporation or its local sales representative for detail.  
Product Name U10 USB Network Interface - TP/FT-10 Channel Model Number 75010R

# Network Converter



## UTY-VGGX

- This Network Converter is to be used for connecting single split system or Group Remote Controller (UTY-CGGY/UTY-CGGG) with the VRF system.
- Please select the function by switching the dip switch during the installation.

### Used for connecting single split system

- Split type systems can be centrally controlled from Touch Panel Controller or System Controller through connection to the VRF's network converter.
- On / Off Control, Master control, Room temperature and Fan speed setting via the Network Converter are available.
- One Network Converter can be used to connect and control up to 16 single units.

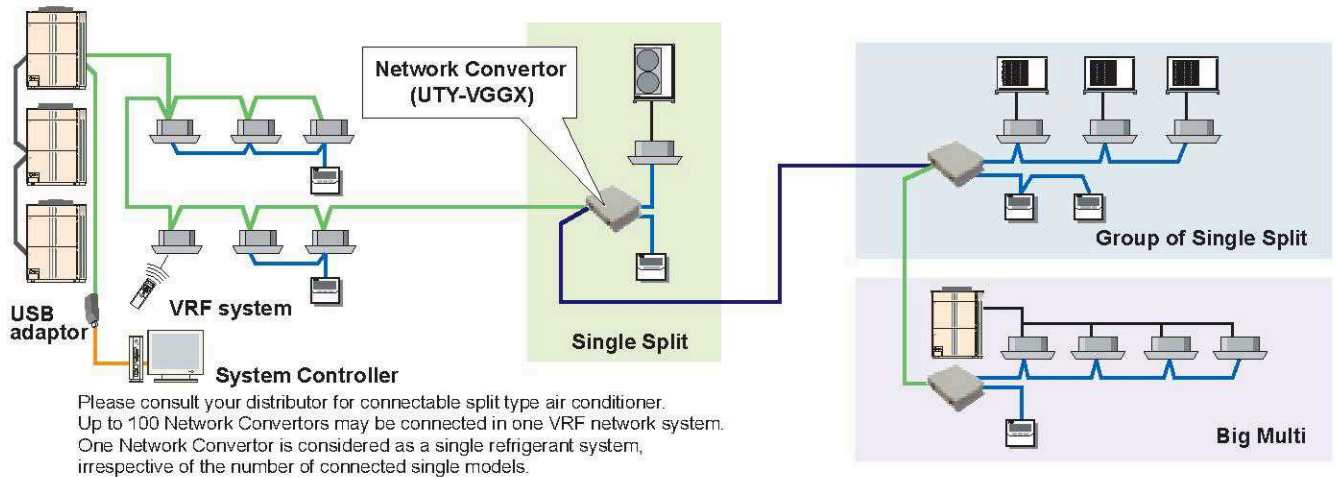

### Used for connecting Group Remote Controller

- 4 Group Remote Controllers can be connected to a single Network Converter (UTY-VGGX).



### Specifications

Model name	UTY-VGGX
Power Supply	220-240V 50/60Hz
Power Consumption (W)	6.5
Dimensions (H x W x D) (mm)	67 x 288 x 211
Weight (g)	1,500

### Dimensions

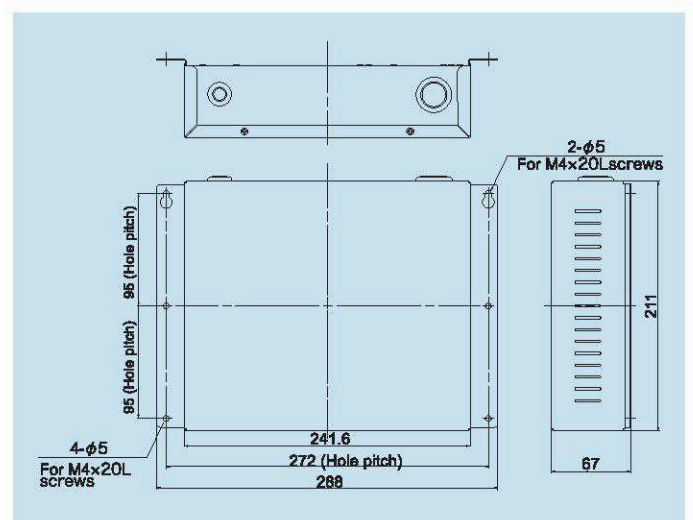

# Network Converter for LONWORKS® (Future Release)

## UTY-VLGX

Max. controllable  
**128** units  
indoor units



- For connection between VRF system and a LONWORKS® open network for management of small to medium-sized BMS and VRF systems.
- The UTY-VLGX permits central monitoring and control of a VRF system from a BMS through a LONWORKS® interface.
- Up to 128 Indoor units can be connected to one Network Converter for LONWORKS®

## Installation example

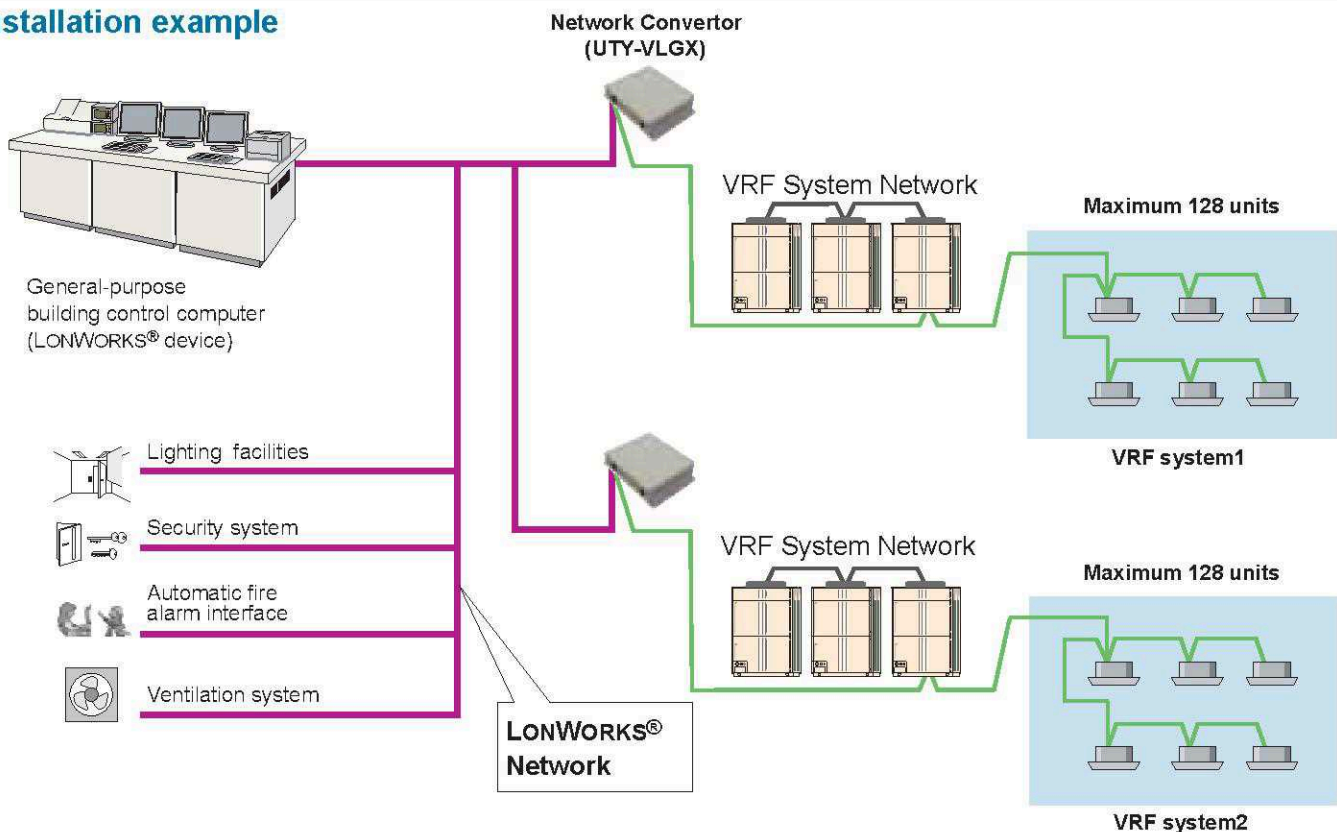

## Specifications

Model name	UTY-VLGX
Power Supply	220-240V 50/60Hz
Power Consumption (W)	4.5
Dimensions (H x W x D) (mm)	67 x 288 x 211
Weight (g)	1,500

## Dimensions

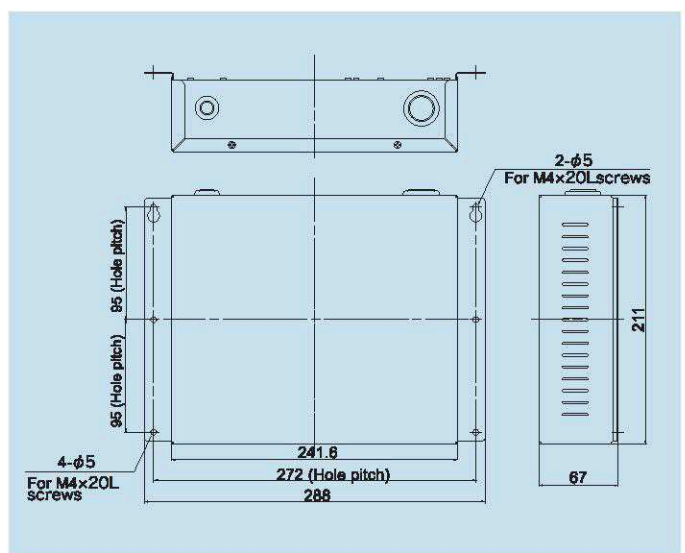

## Transmission specifications (BMS side)

Transmission speed	78kbps
Transceiver	FTT-10A
Transmission way form	Free topology
Terminated resistor	None (It attaches at the terminal of a network.)

# BACnet® Gateway Software (Future Release)

UTY-ABGX

Max. controllable <b>4</b> VRF system	Max. controllable <b>400</b> outdoor units	Max. controllable <b>1,600</b> indoor units
---	--	---

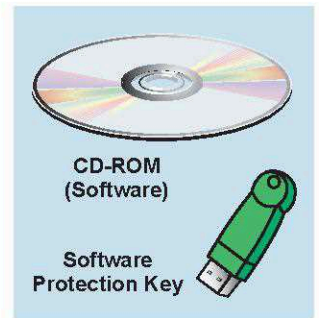

- The VRF system can be incorporated into a Building Management System.
- Enables central control of up to 1,600 indoor units through BACnet®, a global standard for open networks.
- Conforms to ANSI / ASHRAE Standards® 135-2001 BACnet® Application Specific Controller (B-ASC) BACnet® / IP over Ethernet.
- Connects up to 4 VRF systems (1,600 indoor units / 400 outdoor units) per gateway.
- Ideal for applications in high rise buildings and hotels, etc.

## Installation example

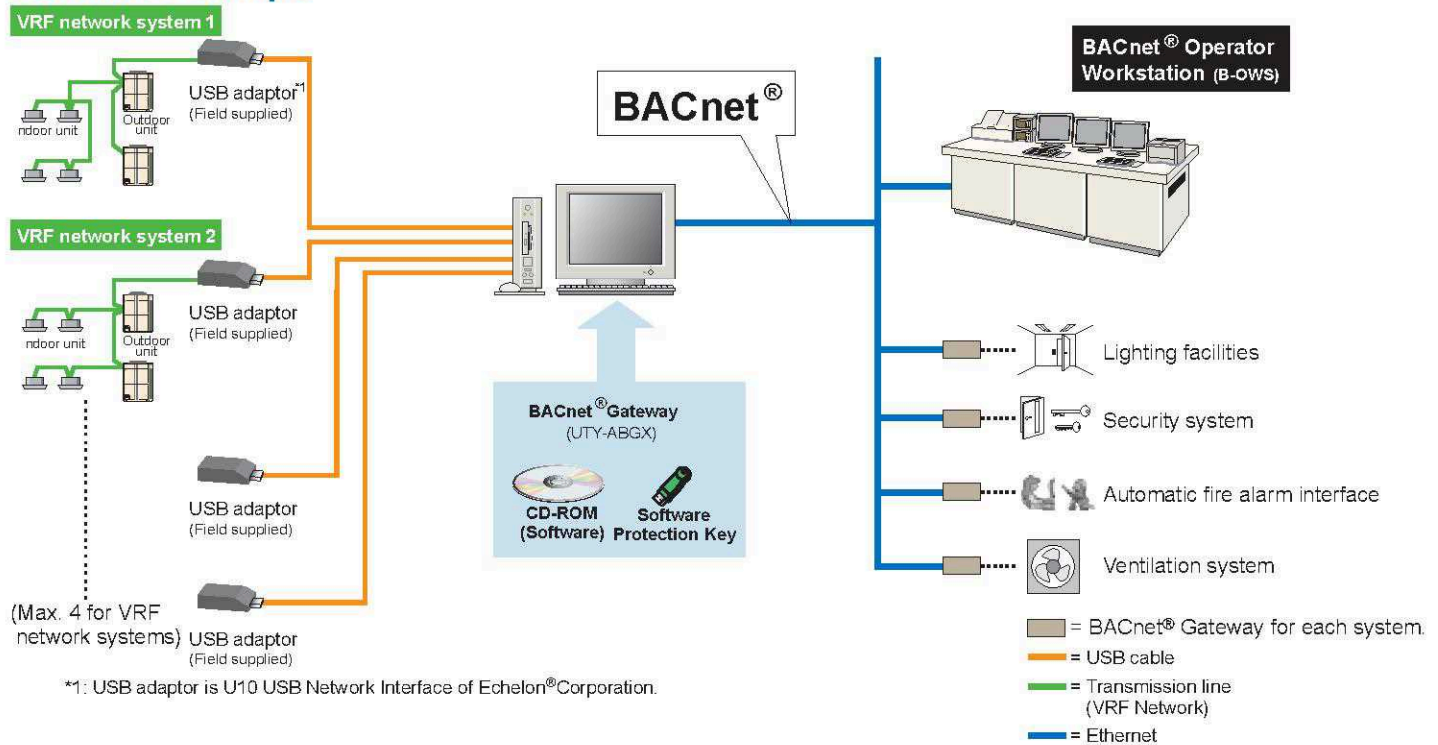

## Requirements of PC for this software

Personal Computer	AT compatible machine that runs Microsoft® Windows®
Operating System	Microsoft® Windows® Vista Home Premium, Business, Ultimate Edition Microsoft® Windows® XP Professional with Service Pack2 or later
CPU	Intel® Pentium® / Celeron 2GHz or higher
Memory	1GB (Vista) , 512MB (XP) or more
Display	1024 x 768 dots or more
Interface	USB port is required for each of the followings; -Wibu Key (Software protection key) - Echelon® U10 USB Network Interface (Required for each VRF Network) Ethernet port is required
Other Software Required	Adobe® Acrobat® reader 4.0 or later

### <PACKING LIST>

Packing List	CD-ROM / Wibu Key
--------------	-------------------

# Signal Amplifier

## UTY-VSGX

- Transmission Line length can be extended up to 3,600m with multiple Signal Amplifiers.
- Up to 8 signal amplifiers can be installed in a VRF network system.
- A signal amplifier is required,
  - (1) When the total wiring length of the transmission line exceeds 500m.
  - (2) When the total number of units on the transmission line exceeds 64.



### Installation example

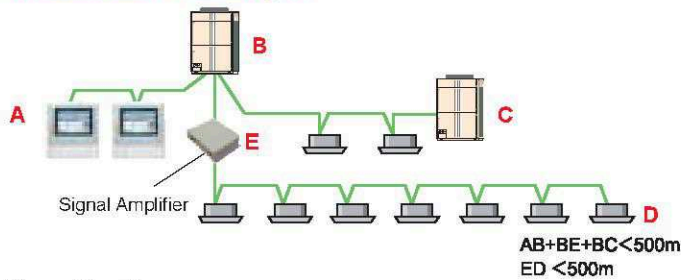

### Specifications

Model name	<b>UTY-VSGX</b>
Power Supply	220-240V 50/60Hz
Power Consumption (W)	4.5
Dimensions (H X W X D) (mm)	67 X 288 X 211
Weight (g)	1,500

### Dimensions

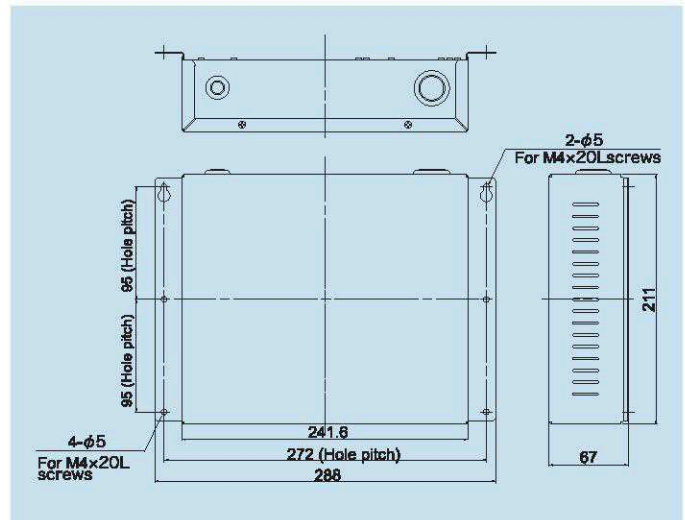

# External Switch Controller

## UTY-TEKX

Air conditioner switching can be controlled by connecting other sensor switches

- In combination with a field supply Card-Key Switch or other sensor, the External Switch Controller allows control of the ON / OFF, Room temperature, Fan speed and Master control functions. This makes this product suitable for installations such as hotel rooms.
- Card-key or other sensor switches are available as a field supplied parts.



### Installation example

- Auto mode operation, which switches the cooling and the heating automatically, is enabled by using the sensor switch and External Switch Controller.
- Note: All indoor units will operate in the same mode.

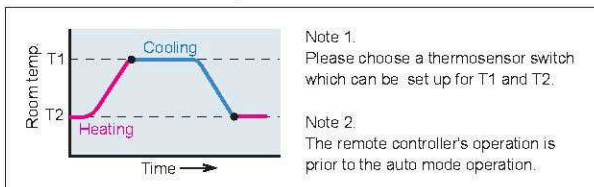

T1 = ON, T2 = OFF

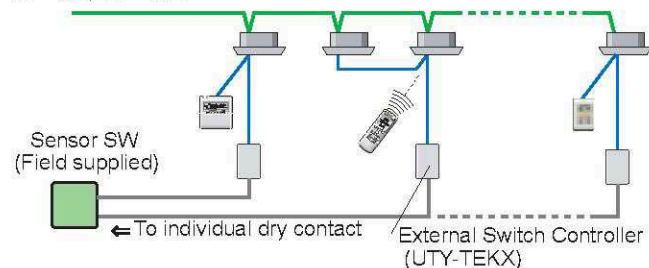

### Electrical wiring

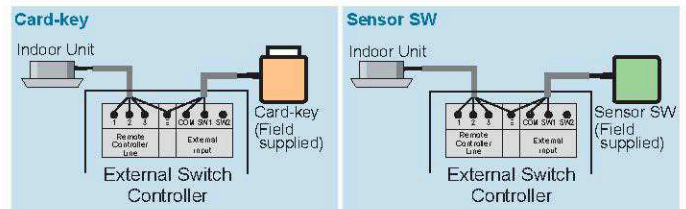

### Specifications

Model name	<b>UTY-TEKX</b>
Power Supply	DC 12V
Dimensions (H x W x D) (mm)	120 x 75 x 30
Weight (g)	90

DC12V is supplied by the indoor unit.

# Service Tool Software

## UTY-ASGX

Extensive monitoring and analysis functions for installation and maintenance

- Operation status can be checked and analyzed to detect even the smallest abnormalities.
- Storage of data on system operation status on a PC allows access even from off site.
- Up to 400 indoor units (a single VRF system) can be controlled and monitored for large scale buildings or hotels.
- This software can be connected to any point of transmission line with USB adaptor (field supplied)

Max. Monitor and control  
**100**  
outdoor units

Max. Monitor and control  
**400**  
indoor units



### Wiring connection

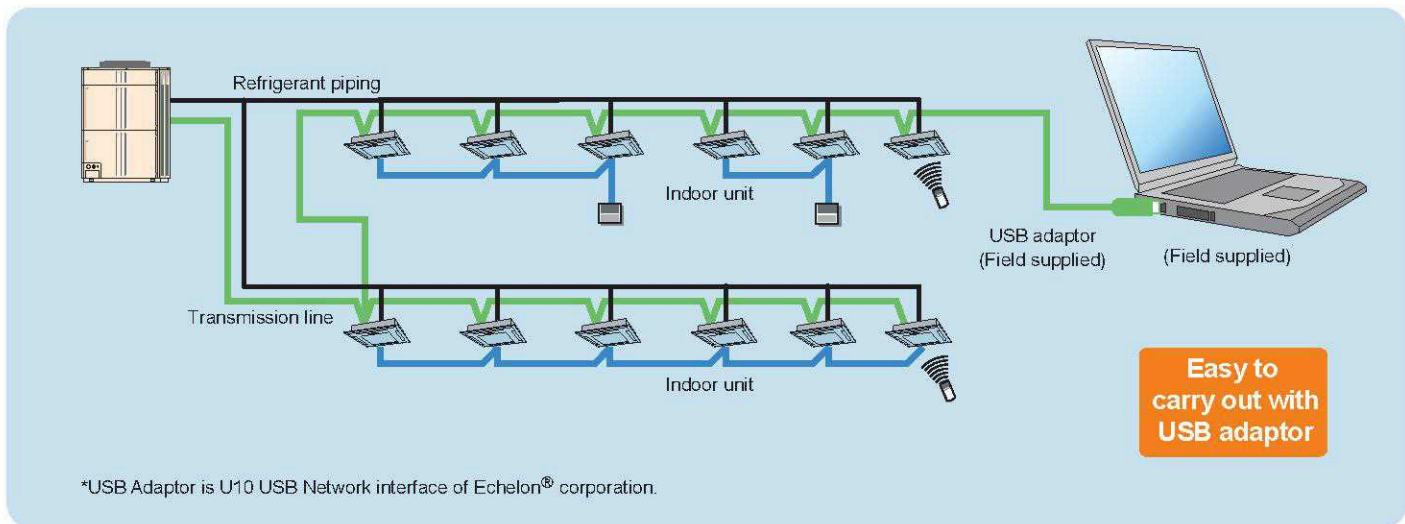

### Functions

Equipment Detail (Diagram)

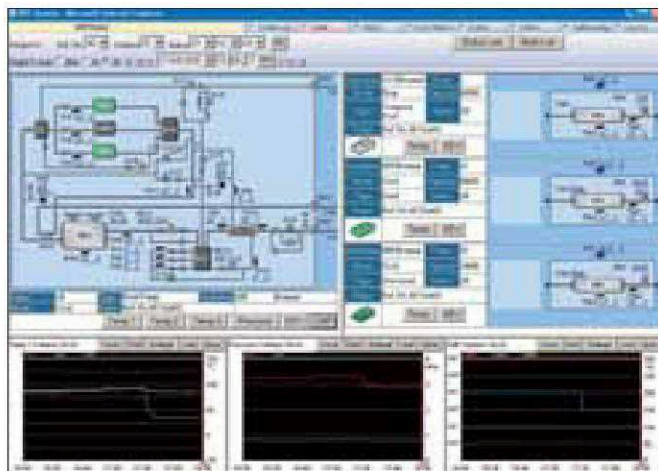

Displays the detail information for sensor values, electrical components etc. for the specified units in schematic. The information here can be used along with the detail information in list form, to check the operation status of units and make detail analysis on the cause, in case an error occurs.

Equipment Detail (List)

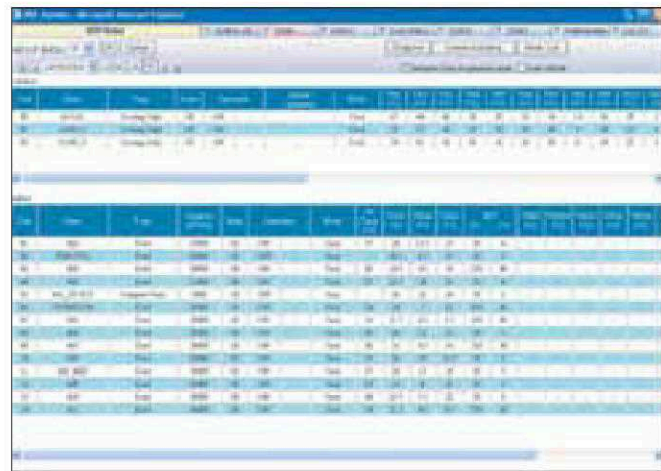

Displays the detail information for sensor values, electrical components etc. of units in a specified refrigerant system in list form. The information here can be used along with the detail information in diagram form, to check the operation status of units and make detail analysis on the cause, in case an error occurs.

## Error History

Unit	Error Code	Error Name	Error Date
...	...	...	...
...	...	...	...
...	...	...	...
...	...	...	...
...	...	...	...
...	...	...	...
...	...	...	...
...	...	...	...
...	...	...	...
...	...	...	...

Displays the error information for each unit. The error information can sequentially be displayed up to 50 items as they occur starting with the latest error.

## System List

Unit No.	Name	Type	Status	...
...	...	...	...	...
...	...	...	...	...
...	...	...	...	...
...	...	...	...	...
...	...	...	...	...
...	...	...	...	...
...	...	...	...	...
...	...	...	...	...
...	...	...	...	...
...	...	...	...	...

Displays the overall operation status of all or specified units in the system in a list form.

## Remote File Download

File Name	Size	Download Status
...	...	...
...	...	...
...	...	...
...	...	...
...	...	...
...	...	...
...	...	...
...	...	...
...	...	...
...	...	...

Operation and error history data can be downloaded. Only the required data may be downloaded specifying the refrigerant system, unit and time range.

## Commissioning Tool

Test run commands can be executed with this tool.  
 During test running, the outdoor unit / indoor unit sensor data can be saved (commissioning log data).  
 After the end of test running, this data can be exported in CSV file format.

## Requirements of PC for this software

Personal Computer	AT compatible machine that runs Microsoft® Windows®
Operating System	Microsoft® Windows® 2000 Professional (English version / Service pack3 or later) Microsoft® Windows® XP Professional (English version / Service pack1 or later) Microsoft® Windows® Vista Home Premium, Business, Ultimate Edition. (English version)
CPU	Intel® Pentium® / Celeron®, AMD Athlon™ / Duron™ 1GHz or higher
HDD	4.1 GB or more of free space
Memory	1GB (Vista) , 256 MB (XP/2000) or more
Interface	USB port is required for each of the following ; -Wibu Key(Software protection key) -Echelon® U10 USB Network Interface(Required for each VRF Network)
Software	Internet Explorer 6.0 or later / Adobe® Acrobat® Reader 4.0 or later
Hardware	USB Adaptor is U10 USB Network interface of Echelon® corporation.

### <PACKING LIST>

Packing List	CD-ROM / Wibu Key
--------------	-------------------

Personal computer must be field supplied.  
 U10 USB Network Interface must be field supplied. Contact EchelonR Corporation or its local sales representative for detail.  
 Product Name: U10 USB Network interface - TP/FT-10 Channel Model Number: 75010R

# Web Monitoring Tool Software

UTY-AMGX

**4**  
VRF system  
can be supported

**1600**  
Indoor unit  
can be monitored

## Product features

- Troubleshooting is performed by monitoring each air conditioning unit remotely during periodical system checks.
- Error notification can be automatically transmitted to several locations using the internet\*.
- Requires either a dedicated internet connection\* or public telephone line.
- Determination of an error occurrence can be made through error warnings and equipment status information obtained from a remote location.
- The monitoring data in a remote side can be optionally downloaded. And, this data can be displayed in offline mode of the service tool.
- Monitoring side computer is not required to install special software, requires only general web browser.

## Web Monitoring System

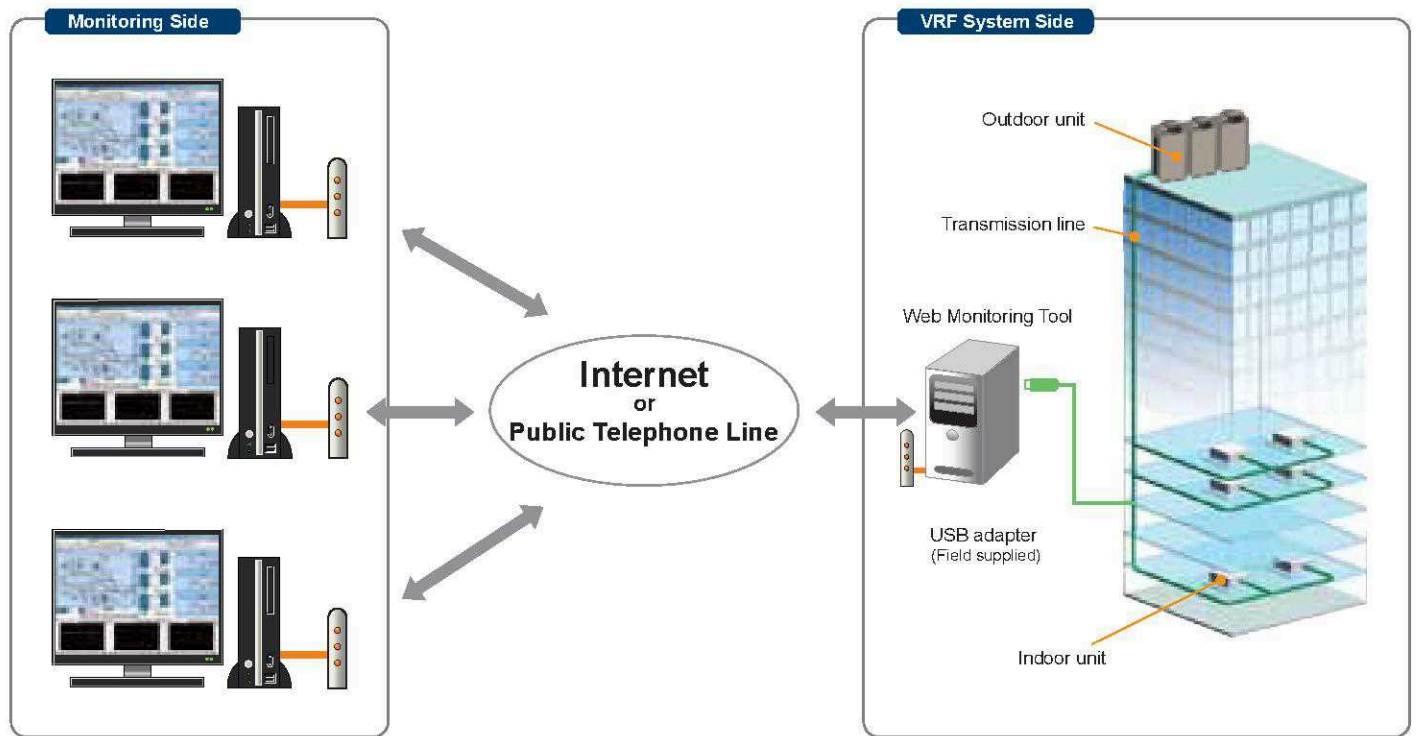

## System components

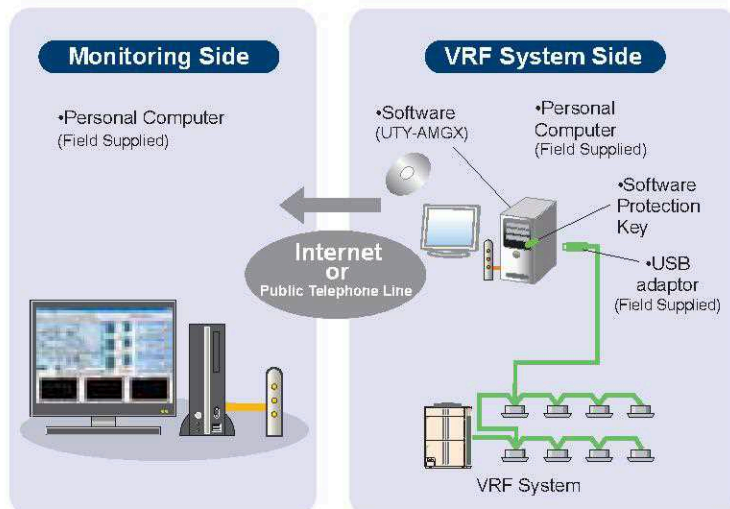

## Support 4 VRF system

- USB adaptor (max. 4 adaptors per PC) permit, monitoring of up to 1,600 indoor units.
- Suitable for large-scale buildings or hotels.

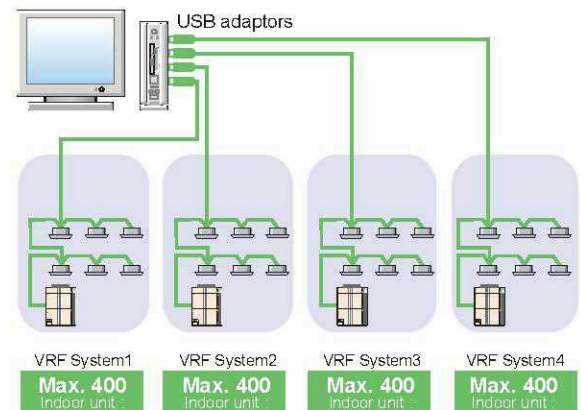

## Comparison table

No.	Item	Service Tool UTY-ASGX	Web Monitoring Tool UTY-AMGX	
			Monitoring Side	VRF System Side
1	Interchangeability of equipment	●	●	●
2	Indication of equipment list	●	●	●
3	Operation control	●	—	●
4	Indication of refrigerant circuit diagram	●	●	●
5	Commissioning tool	●	—	●
6	Monitoring of equipment information	●	●	●
7	Monitoring of operating condition	●	●	●
8	Monitoring of sensor data	●	●	●
9	Storage and CSV output of operating history (sensor data)	●	●	●
10	Indication of trend graph	●	●	●
11	Printing of trend graph	●	●	●
12	Monitoring and screen display of abnormalities	●	●	●
13	E-mail automatic transmission of abnormalities	—	—	●*1
14	Setting for user level	—	—	●

\*1 Available only during a connection to the Internet.

## Requirements of PC for this software

Personal Computer	AT compatible machine that runs Microsoft® Windows®
Operating System	Microsoft® Windows® 2000 Professional (English version / Service pack3 or later) Microsoft® Windows® XP Professional (English version / Service pack1 or later) Microsoft® Windows® Vista Home Premium, Business, Ultimate Edition. (English version)
CPU	Intel® Pentium® / Celeron®, AMD Athlon™ / Duron™ 1GHz or higher
HDD	4.1 GB or more of free space
Memory	1GB (Vista) , 512 MB (XP/2000) or more
Interface	USB port is required for each of the following ; -Wibu Key(Software protection key) -Echelon® U10 USB Network Interface(Required for each VRF Network) Ethernet port is required for remote connection using internet.
Software	Internet Explorer 6.0 or later / Adobe® Acrobat® Reader 4.0 or later
Hardware	USB Adaptor is U10 USB Network interface of Echelon® corporation.

### <PACKING LIST>

Packing List	CD-ROM / Wibu Key
--------------	-------------------

Personal computer must be field supplied.

U10 USB Network Interface must be field supplied. Contact EchelonR Corporation or its local sales representative for detail.

Product Name: U10 USB Network interface - TP/FT-10 Channel Model Number: 75010R

# Optional Parts

## Connection Tube

### Separation Tube

Model : UTR-BP090X

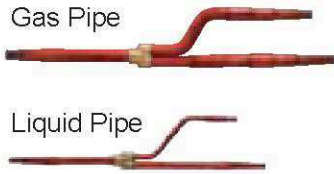

### Separation Tube

Model : UTR-BP180X

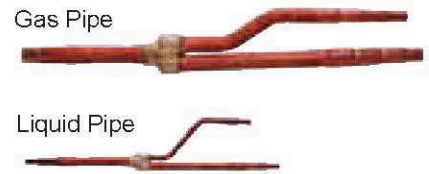

### Separation Tube

Model : UTR-BP567X

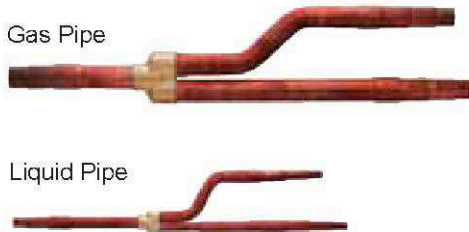

### Outdoor Unit Branch kit

Model : UTR-CP567X

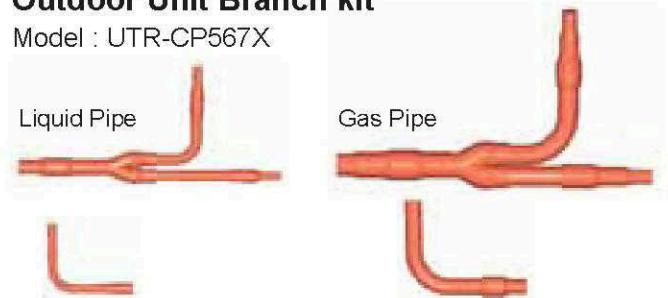

### Header

Model : UTR-H0906L  
UTR-H1806L

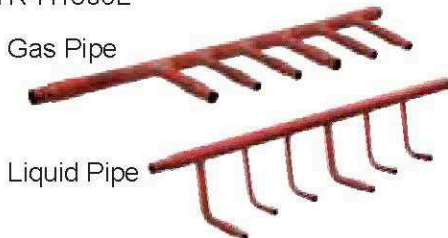

### Header

Model : UTR-H0908L  
UTR-H1808L

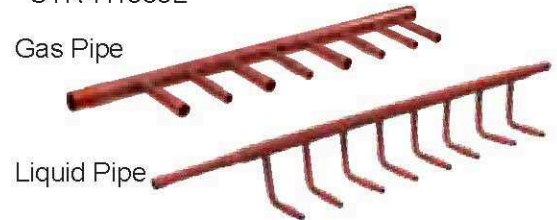

### Outdoor unit Branch kit

Model name	UTR-CP567X	
Number of Outdoor unit	2 outdoor units	1
	3 outdoor units	2

### Separation Tube

Model name	UTR-BP090X	UTR-BP180X	UTR-BP567X
Total model code of indoor unit	90 or less	91 to 180	181 or more

### Header

Model name	6 Branches	UTR-H0906L	UTR-H1806L
	8 Branches	UTR-H0908L	UTR-H1808L
Total model code of indoor unit	90 or less		91 to 180

### EV Kit

Model name	UTR-EV09XB	UTR-EV14XB
Application Model	AS*E07LACH	AS*E12LACH
	AS*E09LACH	AS*E14LACH

AS\* : ASY(FUJITSU), ASH(GENERAL)

## Others

### Flange (Round)

Model : UTD-RF204

For Low Static Pressure Duct type / Duct type



### Flange (Square)

Model : UTD-SF045T

For Low Static Pressure Duct type / Duct type



### Long-Life Filter

Model : UTD-LF25NA

For Low Static Pressure Duct type/Duct type



### Long-Life Filter

Model : UTD-LF60KA

For High Static Pressure Duct type

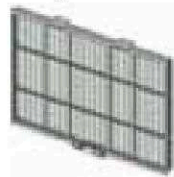

### Drain Pump Unit

Model : UTZ-PX1BBA

For Compact Duct type

Model : UTZ-PX1NBA  
For Low Static Pressure  
Duct type and Duct type



### IR Receiver Unit

Model : UTB-YWB

Model : UTB-GWB

For All Duct type



### Remote Sensor Unit

Model : UTD-RS100

New amenity space can be offered by installing the Remote sensor in the remote controller.

For All Duct type

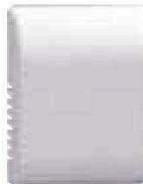

### Drain Pump Unit

Model : UTR-DPB24T

For Ceiling type



### Wide Panel

Model : UTG-AGYA-W

For Cassette type

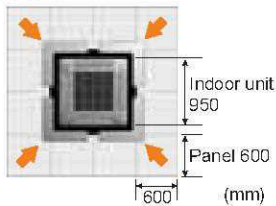

### Panel Spacer

Model : UTG-BGYA-W

For Cassette type

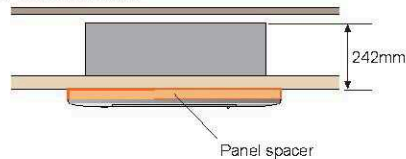

### IR Receiver Kit

Model : UTY-LRHYB1

UTY-LRHGB1

For Cassette type



### Air Outlet Shutter Plate

Model : UTR-YDZB

Shuts the air outlet when only using as 2 or 3 blow out.

For Cassette type



### Air Outlet Shutter Plate

Model : UTR-YDZC

Shuts the air outlet when only using as 2 or 3 blow out.

For Cassette type



### Grille Kit

Model : UTG-UFYB-W

Model : UTG-UFGB-W

For Compact Cassette type



### Grille Kit

Model : UTG-UGYA-W

Model : UTG-UGGA-W

For Cassette type

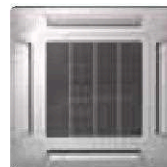

### EV Kit

Model code < 09 : UTR-EV09XB

Model code ≥ 12 : UTR-EV14XB

For Compact Wall Mounted type



# هلدينگ اصغريان



 **ASGHARIAN  
HOLDING**



استان مازندران - آمل  
خیابان امام خمینی (ره) - نبش آفتاب ۲۷ - پلاک ۶۱  
دپارتمان مارکتینگ: ۰۹۱۱۴۶۰۶۱۶۹  
مدیریت فروش: ۰۹۱۱۳۱۰۳۸۲۸  
[www.asgharianco.com](http://www.asgharianco.com)  
[sales@asgharianco.com](mailto:sales@asgharianco.com)  
[marketing@asgharianco.com](mailto:marketing@asgharianco.com)



ISO 9001  
Certified number: 09 100 79269  
Fujitsu General (Shanghai) Co., Ltd.



ISO 14001  
Certified number: 104892  
Fujitsu General (Thailand) Co., Ltd.



ISO 9001  
Certified number: 09 100 89304  
Fujitsu General (Thailand) Co., Ltd.

ISO 14001  
Certified number: 09 104 8245  
Fujitsu General (Thailand) Co., Ltd.

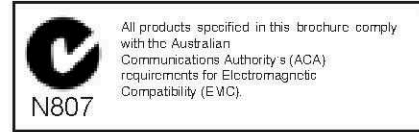

All products specified in this brochure comply with the Australian Communications Authority's (ACA) requirements for Electromagnetic Compatibility (EMC).

"**AIRSTAGE**"<sup>™</sup> is a worldwide trademark of FUJITSU GENERAL LIMITED and is a registered trademark in Japan, the U.S.A. and other countries or areas.

\*Microsoft<sup>®</sup> and Windows<sup>®</sup> are registered trademarks of Microsoft Corporation in the United States.

\*Adobe<sup>®</sup> and Acrobat Reader<sup>®</sup> are registered trademarks of Adobe Systems Incorporated in the United States.

\*Intel<sup>®</sup>, Pentium<sup>®</sup> and Celeron<sup>®</sup> are registered trademarks of Intel Corporation or its subsidiaries in the United States.

\*AMD Athlon<sup>™</sup> and AMD Duron<sup>™</sup> are registered trademarks of Advanced Micro Devices, Inc.

\*Echelon<sup>®</sup>, LONWORKS<sup>®</sup>, and the Echelon logo are trademarks of Echelon Corporation registered in the United States and other countries.

\*BACnet<sup>®</sup> is a registered trademark of the American Society of Heating Refrigeration and Air Conditioning Engineers (ASHRAE).

The colors may be different from the actual colors because this catalog is printed matter.

Product specifications are subject to change without notice.

Distributed by :

Copyright © 2008 Fujitsu General Limited. All rights reserved.

**FUJITSU GENERAL LIMITED**

1116, Suenaga, Takatsu-ku, Kawasaki 213-8502, Japan  
URL : <http://www.fujitsu-general.com>

SEP2008\_CAT\_V001E\_001 Printed in Japan